

Preface	1
Introduction	1
The Owner's Handbook	1
Status at Time of Printing	1
Warranty.....	1
Symbols Used	2
In an Emergency.....	3
Vehicle Identification Information	4
Vehicle Identification	4
Vehicle Identification Label	5
Instructions for Use of Hybrid Vehicle	7
Effects of Ambient Temperature	7
Instructions for High Voltage Battery Pack Recycling	7
Equalisation Charging.....	8
Intelligent Charging.....	8
High Voltage System.....	9
In The Event of an Accident.....	11
I Instruments and Controls	13

CONTENTS

Instruments and Controls	14
Instrument Pack	16
Message Centre	19
Vehicle Information Display	19
Warning Lights and Indicators.....	35
Lights and Switches.....	50
Master Light Switch	50
Headlamp Levelling Manual Adjustment	51
Direction Indicator/Master Lighting Switch	52
Smart Main Beam System	54
Fog Lamp Switch	56
Hazard Warning Lamps	56
Wipers and Washers	57
Front Windscreen Wiper Controls	57
Rear Windscreen Wiper Controls	59
Steering System	61
Adjustment of Steering Column.....	61
Electric Power Steering	62

Horn	63
Rearview Mirrors	64
Exterior Door Mirrors	64
Automatic Anti-dazzle Interior Rearview Mirror	66
Sunvisor	68
Windows	69
Power Operated Window Switch	69
Window Operation.....	69
Sunroof *	72
Instructions	72
Sunroof Operation	73
Interior Light	78
Front Interior Lamp	78
Rear Interior Lamp *	79
Ambient Lamps *	79
Power Socket	80
Storage Devices	82
Instructions	82

CONTENTS

Glove Box	82
Storage Box – Driver Side	83
Centre Console Armrest Box	83
Loadspace	84
Cup Holder	85
Centre Console Cup Holder	85
Rear Armrest and Rear Cup Holder	85
Roof Luggage Rack *	86
Maximum Authorised Load for the Roof.....	86
Periodical Check.....	86
2 Air Conditioning.....	87
Ventilation	88
A/C Particle/Pollen Filter	89
Vents	89
Automatic Temperature Control	91
Infotainment Screen Control Interface.....	91
Control Panel	94
A/C Status	96

3 Seats & Restraints	97
Seats	98
Overview	98
Head Restraint.....	98
Front Seats	99
Rear Seats	101
Front Seat Heating.....	102
Seat Belts	103
Protection Provided by Seat Belts	104
Wearing Seat Belts	105
Children and Seat Belts	110
Seat Belt Pre-tensioners	111
Seat Belt Checks, Maintenance and Replacement	112
Airbag Supplementary Restraint System	114
Overview	114
Airbag Deployment	115
Conditions in Which Airbags Will Not Deploy	118
Disabling the Passenger Airbag.....	119
Service and Replacement of Airbags	121

CONTENTS

Disposal of Airbags.....	122
Child Restraints	123
Important Safety Instructions about Using Child Restraints	123
Child Restraints Groups.....	126
Approved Child Restraint Positions	128
4 Starting & Driving.....	133
Keys	134
Overview	134
Replacing the Battery	135
Child Proof Locks	137
Alarm Systems	138
Power Immobilisation	138
Body Anti-theft System	138
Manual Tailgate *	143
Electric Tailgate *	144
Tailgate Emergency Open	147
Starting and Stopping Power System.....	148
START/STOP Switch	148

READY Mode.....	149
Switching the Power System OFF.....	152
Pedestrian Alert Control System	153
Economical and Environmental Driving	154
Running-in.....	154
Environment Protection.....	154
Economic Driving and Maintenance.....	154
Driving in Special Environment.....	156
Catalytic Converter and Particulate Filter.....	157
Fuel System.....	159
Fuel Requirements.....	159
Fuel Filler	160
Refueling.....	162
Vehicle Hybrid Control.....	163
Crash Outage Control	163
Electric Power Management Mode.....	163
Power Limit of Electrical Appliances.....	163
Charging Requirements.....	164
Charging Your Vehicle at Home.....	166

CONTENTS

Installed Charging Points	166
Home Charging Guide.....	166
Charging and Medical Condition Awareness	167
Charging Port	167
Charging Operation	169
Charging Information	171
Equalisation Charging.....	172
Charging Times	172
Electric Drive Transmission (10-Speed).....	173
Instructions	173
Gear Shift.....	173
Vehicle Start-off.....	175
Driving on Hills	176
Energy Regeneration.....	176
Electric Power Management Mode.....	177
Protection Mode.....	178
Brake System	181
Foot Brake.....	181
Electronic Brake Force Distribution (EBD)	182

Electronic Brake Assistance (EBA)	182
Hill Hold Control (HHC)	182
Auto Hold	184
Hill Descent Control (HDC)	186
Anti-lock Brake System (ABS)	188
Active Rollover Protection (ARP)	189
Emergency Braking Hazard Warning Lights Control System (HAZ)	190
Electronic Parking Brake (EPB).....	191
Stability Control System (SCS) and Traction Control System (TCS)	194
Tyre Pressure Monitoring System (TPMS)	196
Adaptive Cruise Control System.....	197
Adaptive Cruise Control System Activation	198
Adaptive Cruise Target Speed Adjustment	201
Adaptive Cruise Target Following Distance Adjustment	202
Adaptive Cruise Pause.....	202
Automatic Deactivation of Adaptive Cruise	202
Adaptive Cruise Override	203
Adaptive Cruise Resume	203
Clear the Speed Memory	203

CONTENTS

Special Driving Environments	204
Parking Aid System	207
Ultrasonic Sensor Parking Aid	207
360 Around View System	208
Rear Driver Assistance System.....	211
System Overview	211
Switching the System Functions On/Off	212
System Functions	213
Driving Assist System	218
Description of Front View Camera	218
Description of Front Detection Radar	219
Speed Assist System (SAS)	221
Lane Departure Warning System (LDW)	226
Lane Departure Prevention System (LDP)	229
Lane Keeping Assist System (LKA)	233
MG Pilot System	237
Forward Collision Warning System (FCW)	242
Automatic Emergency Braking System (AEB) and Automatic Emergency Braking System for Pedestrians (AEBP)	243

Load Carrying	248
Load Space.....	248
Internal Loading	249
General Towing Safety	249
5 Emergency Information	251
Hazard Warning Devices	252
Hazard Warning Lamps	252
Warning Triangle.....	252
eCall - SOS Emergency Assistance	254
Emergency Starting	257
Using Booster Cables	257
Starting the Car	257
Vehicle Recovery	260
Towing for Recovery.....	260
Transporter	262
Tyre Repair and Wheel Replacement	263
Tool Identification	263
Tyre Repair	263

CONTENTS

Changing a Wheel *	267
Fuse Replacement	270
Fuse	270
Luggage Compartment Fuse Box	272
Passenger Compartment Fuse Box	275
Front Compartment Fuse Box	279
Bulb Replacement	283
Bulb Specification	283
Bulb Replacement	283
6 Maintenance	291
Maintenance	292
Routine Servicing	292
Bonnet	295
Opening the Bonnet	295
Closing the Bonnet	295
Bonnet Open Warning	295
Engine Compartment	297
Engine	298

1.5L Turbocharged Engine Oil	298
Engine Oil Level Check and Top Up	298
Engine Oil Specification	299
Cooling System.....	300
Coolant Check and Top Up	300
Coolant Specification	301
Brake	302
Brake Pads	302
Brake Fluid Check and Top Up	302
Brake Fluid Specification	303
Battery.....	304
Battery Maintenance	304
Battery Replacement.....	304
High Voltage Battery Pack	306
Precautions and restricted conditions for use of battery	306
Washer	308
Washer Fluid Check and Top Up	308
Washer Nozzles	309
Wipers	310

CONTENTS

Wiper Blades	310
Replacing Front Windscreen Wiper Blades	311
Replacing Rear Window Wiper Blades	312
Tyres	313
Overview	313
Caring for Your Tyres	315
Tyre Wear Indicators	315
Replacement of Tyres	316
Wheel Fitment Rotation	316
Tyre/Snow Chains	317
Cleaning and Vehicle Care	319
External Care	319
Cleaning the Interior.....	323
7 Technical Data.....	325
Technical Data Dimensions	326
Weights.....	328
Towing Weights.....	329
Towing Bar Dimensions.....	330

CONTENTS

Major Parameters of Engine	332
Parameters of Drive Motor	333
Recommended Fluids and Capacities	334
Four-Wheel Alignment Parameter Table (Unladen)	335
Wheels and Tyres	335
Tyre Pressure (Cold)	335
8 Appendix	337
Removable Tow Bar	338
Tow Bar Operating Instructions.....	338

Introduction

The Owner's Handbook

This handbook describes all of the vehicles and standard equipment specification within the model range. Some of the information therefore, may not apply to your particular car.

Always remember that if you have any queries concerning the operation or specification of your car, your MG Authorised Repairer will be glad to advise you.

The illustrations in the Owner's Handbook are for reference only.

The information presented in this manual may vary slightly depending on vehicle configuration, software version and sales area.

Status at Time of Printing

MG operates a policy of constant product improvement and therefore reserves the right to change specifications without notice at any time. Whilst every effort is made to ensure complete accuracy of the information in this publication, no liabilities for inaccuracies or the

consequences thereof, including loss or damage to property, or injury to persons, can be accepted by the manufacturer or MG Authorised Repairer who supplied the publication, except in respect of personal injury caused by the negligence of the manufacturer or MG Authorised Repairer.

Warranty

Please consult www.mg.co.uk for the vehicle warranty terms and conditions, warranty statement and exemptions.

PREFACE

Symbols Used

The following symbols used within the handbook call your attention to specific types of information.

Warning



This warning symbol identifies procedures that must be followed precisely, or information that must be considered with great care, in order to reduce the risk of personal injury or serious damage to the car.

Important

IMPORTANT

The statements stated here must be followed strictly, otherwise your car could be damaged.

Note

Note: *This describes helpful information.*



This symbol indicates parts described must be disposed of by authorised persons or bodies to protect the environment.

Asterisk

An asterisk (*) appearing within the text, identifies features or items of equipment that are either optional, or are only fitted to some vehicles in the model range.

Illustration Information



Identifies components being explained.



Identifies movement of components being explained.

In an Emergency

IMPORTANT

Remember the breakdown safety code

If a breakdown occurs while travelling:

- Wherever possible, consistent with road safety and traffic conditions, the car should be moved off the main thoroughfare, preferably into a lay-by. If a breakdown occurs on a motorway, pull well over to the inside of the hard shoulder.
- Switch on hazard lights.
- If available, position a warning triangle or a flashing amber light 150 to 500 ft behind your vehicle to warn approaching traffic. Note it is a legal requirement of some countries that a warning triangle is carried in the vehicle, if in doubt consult the local highways agency for further information.
- Consider evacuating passengers through nearside doors onto the verge as a precaution in case your vehicle is accidentally struck by other traffic.

PREFACE

Vehicle Identification Information

Vehicle Identification

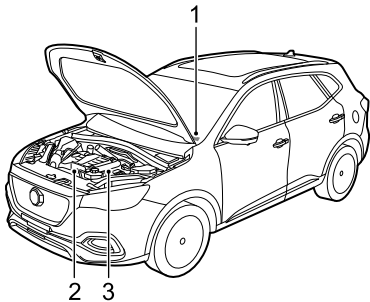

- 1 Vehicle Identification Number (VIN)
- 2 Engine Number
- 3 Electric Transmission Number

Always quote the Vehicle Identification Number (VIN) when communicating with your MG Authorised Repairer. If the engine or electric drive transmission is involved, it

may be required to provide the identification numbers of these assemblies.

Vehicle Identification Location

Vehicle Identification Number (VIN)

- On the floor under the driver's seat;
- Stamped on a plate visible through the bottom left hand corner of the windscreen;
- On the vehicle identification plate;
- On the inner side of the tailgate visible by opening the tailgate.

Note: The DLC is located in the driver footwell at the base of the fascia panel on the LH side. The VIN information can be extracted from the vehicle using the approved diagnostic equipment.

Engine Number Location

Stamped on the front right of the cylinder block (View from the front of the engine).

Electric Transmission Number

Stamped on the upper surface of the electric transmission housing

Vehicle Identification Label

The vehicle identification label contains the following information:

- Type Approval Number
- Vehicle Identification Number (VIN)
- Gross Vehicle Weight
- Gross Train Weight
- Max Front Axle Weight
- Max Rear Axle Weight
- Paint Code
- Trim Code

PREFACE

Location of Vehicle Identification Label

The identification label is located at the lower side of right pillar B

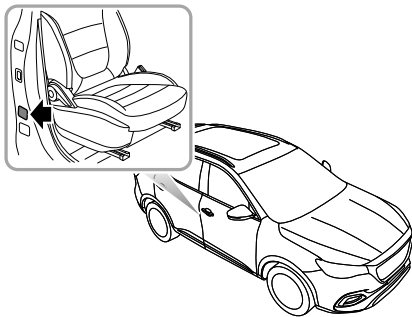

Instructions for Use of Hybrid Vehicle

Effects of Ambient Temperature

The working performance of the high-voltage battery pack fitted to your vehicle is related to the ambient temperature, this battery powers the vehicle power system and therefore it is recommended that where possible the vehicle should be used within the temperature range of -30°C - 50°C. This will ensure that the vehicle is at the optimum working state, and help extend the service life of high-voltage battery pack. Extremely high or low temperatures will affect the performance of high-voltage battery pack and vehicle.

Instructions for High Voltage Battery Pack Recycling

The high-voltage battery pack fitted to your vehicle contains several lithium based battery cells, is installed centrally to the motor-vehicle chassis. Arbitrary disposal may cause pollution, hazard and damage to the environment. The high-voltage battery pack **MUST** be recycled by an MG Authorised Repairer or a professional

approved dismantling agent. Please refer to the following information and requirements.

- **ONLY** qualified personnel should work with the high voltage system - there is danger of DEATH.
- High voltage safety: the high voltage system fitted to your vehicle features a HV battery containing high voltage components such as lithium battery packs and high voltage wiring harness; **DO NOT** attempt to dismantle any area of this system, suitably trained professional staff must observe insulation safety protection before working on or near the high voltage system.
- Transportation: The high-voltage battery pack is classed as a Category 9 hazardous material and must be transported by vehicles qualified in transporting Category 9 hazardous materials.
- Storage: All HV components (including batteries) should be stored at room temperature and in a dry environment. They must be kept away from dangerous sources, such as flammable objects, heat and water sources.

PREFACE

- Internal composition: The high-voltage battery pack consists of lithium batteries (pack), PCB, HV and normal electric wiring, metal casing and other components.

It is strongly recommended that the used high-voltage battery pack generated from vehicle scrappage or other reasons should be disposed of by an MG Authorised Repairer. See official Website for details: www.mg.co.uk.

Note: Instructions: If you decide not to use the recommended MG Authorised Repairer to dispose of your high voltage battery, the responsibility of the consequences of environmental pollution or accidents must be borne by the owner.

Equalisation Charging

In order to assist in extending the service life of the high voltage battery pack is recommended that an equalisation charge is carried out at regular intervals.

Please see "Equalisation Charging" in the "Starting & Driving" section.

Intelligent Charging

The 12V battery SOC is constantly monitored, when the Start/Stop switch is in the OFF position it is possible, under certain conditions, that the HV battery will automatically charge the 12V battery to ensure the vehicle starts. This function will activate and switch off automatically.

Note: The system will suspend intelligent charging if a fault is present, when starting or the vehicle is being charged by an external device.

Note: The driving range will be reduced after intelligent charging.

Note: The intelligent charging function is suspended when the high voltage battery is in a low SOC.

Note: The intelligent charging function will not 'start the engine'.

High Voltage System



- *The high voltage system used on your vehicle features AC and DC voltages up to 376V. All high voltage components have warning labels attached - please observe these warnings and any requirements when operating within or close to these areas.*
- *ONLY qualified personnel should work on, or with, the high voltage system - there is danger of DEATH.*

PREFACE

The high-voltage system component layout is shown below:

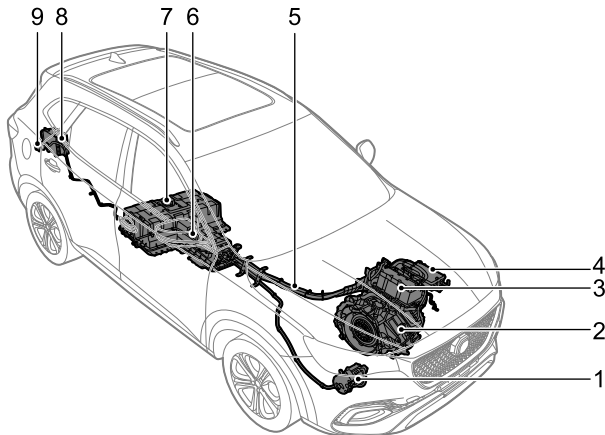

- 1 Electric A/C Compressor
- 2 Electrical Drive Unit
- 3 Power Electronic Box
- 4 DC/DC Converter
- 5 High Voltage Harness
- 6 High Voltage Battery (ESS)
- 7 Manual Service Disconnect (MSD)
- 8 On Board Charger
- 9 Charging Port

In The Event of an Accident



- *Ensure the vehicle is in P, the parking brake is applied and the vehicle power system is OFF.*
- *If any cables on the vehicle are exposed, in order to prevent electric shock or even death DO NOT make any contact with any cable.*
- *If the vehicle catches fire, and the fire is small and slow, a carbon dioxide extinguisher can be used to extinguish the fire, and contact the fire department as soon as possible; if the fire is large and spreading quickly, immediately evacuate the vehicle and contact the fire department immediately.*
- *If the vehicle is involved in a collision and cannot be re-started, the master safety switch - Manual Service Disconnect (MSD) MUST be disconnected prior to rescue.*
- *When the vehicle is completely or partially immersed in water, switch off the vehicle*

- *power system and evacuate the car immediately. The master safety switch - Manual Service Disconnect (MSD) MUST be disconnected prior to rescue or as soon as the vehicle is refloated/removed from the water. Observe the water/vehicle for any abnormal signs such as excessive bubbles or noises, this may indicate battery short circuit issues, if no signs are evident there should not be a shock risk from the bodywork and recovery can commence.*
- *If your car is being recovered by an independent recovery agent, please contact an MG Authorised Repairer for maintenance.*
- *The vehicle is supplied with a rescue information card (in the glove box). Please show the card to the rescue personnel when they arrive.*

Instruments and Controls

- | | |
|---|-------------------------------|
| <i>14 Instruments and Controls</i> | <i>80 Power Socket</i> |
| <i>16 Instrument Pack</i> | <i>82 Storage Devices</i> |
| <i>19 Message Centre</i> | <i>85 Cup Holder</i> |
| <i>35 Warning Lights and Indicators</i> | <i>86 Roof Luggage Rack *</i> |
| <i>50 Lights and Switches</i> | |
| <i>57 Wipers and Washers</i> | |
| <i>61 Steering System</i> | |
| <i>63 Horn</i> | |
| <i>64 Rearview Mirrors</i> | |
| <i>68 Sunvisor</i> | |
| <i>69 Windows</i> | |
| <i>72 Sunroof *</i> | |
| <i>78 Interior Light</i> | |

INSTRUMENTS AND CONTROLS

Instruments and Controls

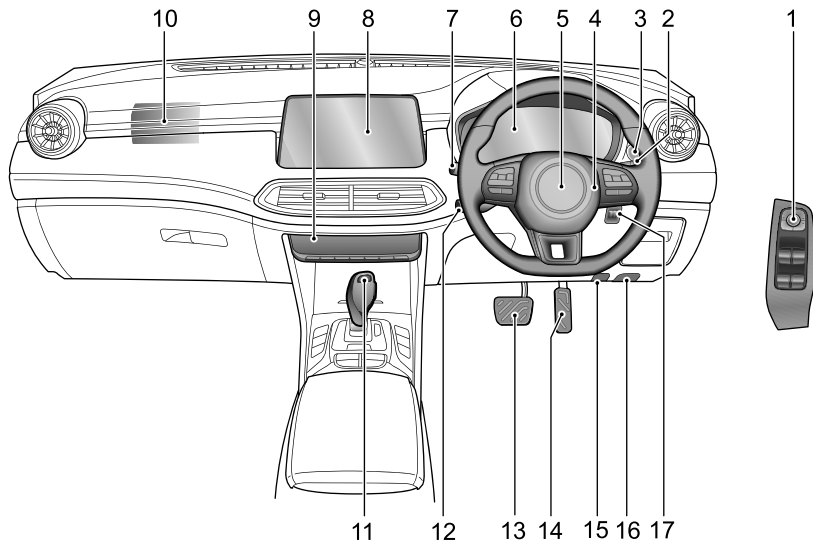

- 1 Exterior Rearview Mirrors and Power Window Switch
- 2 Wiper/Washer Control
- 3 START/STOP Switch
- 4 Horn Button
- 5 Driver Airbag
- 6 Instrument Pack
- 7 Indicator and Main Beam Stalk Switch
- 8 Onboard Entertainment System
- 9 Entertainment/Air Conditioning Controls
- 10 Front Passenger Airbag
- 11 Gear Shift Lever
- 12 Cruise Stalk Switch
- 13 Brake Pedal
- 14 Accelerator Pedal
- 15 Fuel Filler Flap Release Switch
- 16 Bonnet Release Handle
- 17 Headlamp Levelling Adjustment Switch

INSTRUMENTS AND CONTROLS

Instrument Pack

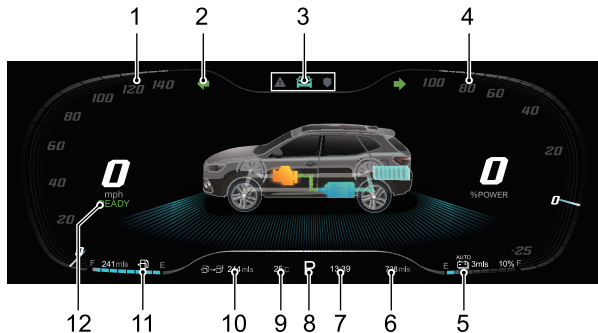

- 1 Speedometer
- 2 Warning Lights and Indicators
- 3 Message Centre
- 4 Power Meter
- 5 Electricity Meter and Electricity Driving Range to Empty
- 6 Odometer
- 7 Time
- 8 Gear Display
- 9 Ambient Temperature
- 10 Total Range to Empty
- 11 Fuel Gauge and Fuel Driving Range to Empty
- 12 Power System State

Speedometer

Indicates the vehicle speed in mph.

Warning Lights and Indicators

Please refer to "Warning Lights and Indicators" in this chapter.

Message Centre

Please refer to "Message Centre" in this chapter.

Power Meter

Indicates the power status of the power drive system as a percentage. If the power is displayed as a positive value, it represents that the power system outputs power to drive the vehicle; If the power is displayed as a negative value, it represents that the power system converts part of the kinetic energy into electrical energy

Electricity Meter and Electricity Driving Range to Empty

Displays the current level of high voltage battery charge as a percentage and the remaining range of the vehicle before the high voltage battery becomes flat.

The high-voltage battery pack low battery warning lamp will illuminate when the high voltage battery charge is low. If the voltage continues to drop, this lamp will flash.

The instrument pack will display the selected power management mode. Please refer to "Electric Power Management Mode" in "Starting & Driving" chapter for more information about the power management mode.

Odometer

Displays the total distance the vehicle has travelled.

Time

Displays the current time.

INSTRUMENTS AND CONTROLS

Gear Display

Displays the shift lever position of the current electric drive transmission (P, R, N, D).

If 'EP' is displayed, it indicates a serious functional failure with the gear shift system. In this case, please contact an MG Authorised Repairer immediately.

Ambient Temperature

Displays the current ambient temperature.

Total Driving Range to Empty

Displays the remaining distance the vehicle can travel before the fuel in the fuel tank and the high-voltage battery pack run out.

Fuel Gauge and Fuel Driving Range to Empty

Indicates the quantity of fuel in the fuel tank by the number of segments illuminated, and also displays the remaining distance you can travel before the fuel tank becomes empty.

The low fuel warning lamp will illuminate yellow or flash when the fuel remaining in the fuel tank is low.

IMPORTANT

If the low fuel warning lamp illuminates, please refuel as early as possible.



The arrow to the left of low fuel warning lamp indicates that the fuel filler is located at the left side of the vehicle.

Power System State

READY indicates that the power system is ready for driving.

POWER OFF indicates that the power system is in the OFF state.

Message Centre

Vehicle Information Display

The vehicle information display contains the following information:

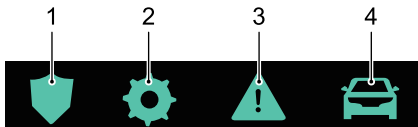

- 1 Active Safety
- 2 Setting
- 3 Warning Information
- 4 Trip Computer

With the START/STOP Switch in the ON/READY position, the vehicle information display function can be selected as follows:

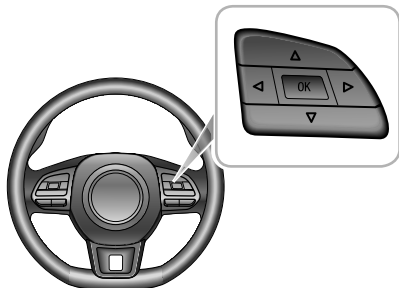

- Press the UP/DOWN/LEFT/RIGHT button in the RH steering wheel multifunction switch pack, this will shift between the display options.
- Press the UP/DOWN button in the RH steering wheel multifunction switch pack to scroll through the options and make any changes.
- Press the OK button in the RH steering wheel multifunction switch pack to confirm your option

INSTRUMENTS AND CONTROLS

selection or long press the OK button to make any resets.

Active Safety

Displays the active safety information of the vehicle.

For more information, please refer to “Driving Assist System” in “Starting & Driving” section.

Setting

Brightness

Displays the current brightness level of the instruments and switches, this can be adjusted. There are 3 levels in total.

OS (Overspeed) Threshold

You can set the value of overspeed threshold.

Next Service

Displays the next service information of the car.

Warning Information

Displays the warning information or important notes that are currently relevant to the vehicle.

Trip Computer

The trip computer function contains the following:

- Hybrid Power Energy Flow Interface
- Current Journey: displays the range, duration, average speed and average consumption since start up. These values will be reset after a period of power off. It can also be reset by long pressing the "OK" button in the RH steering wheel multifunction switch pack.
- Accumulated Total: displays the range, duration, average speed and average consumption since reset. It can be reset by long pressing the "OK" button in the RH steering wheel multifunction switch pack.
- TPMS Monitor: Displays the current tyre pressures and temperatures.
- 12V Battery Voltage: displays the 12V Battery Voltage.
- Hybrid Info: displays the current operation state of the vehicle, including the engine speed, motor speed, voltmeter and ammeter.

Hybrid Power Energy Flow Interface

Parallel Drive Mode

The engine and motor are driving the vehicle simultaneously.

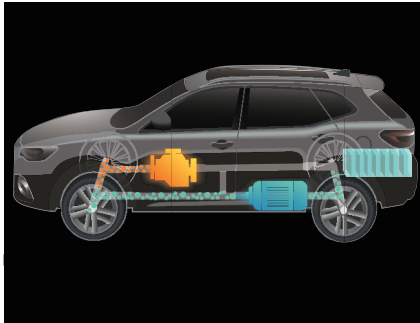

The Vehicle is Stationary with the High Voltage Supply ON

The vehicle is READY.

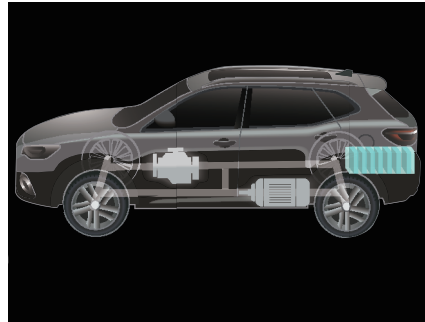

INSTRUMENTS AND CONTROLS

Pure Electric Drive Mode

The vehicle is being driven by the motor only, the engine is not running.



Pure Electric Drive with Engine Idling

The vehicle is being driven by the motor only, the engine is idling.

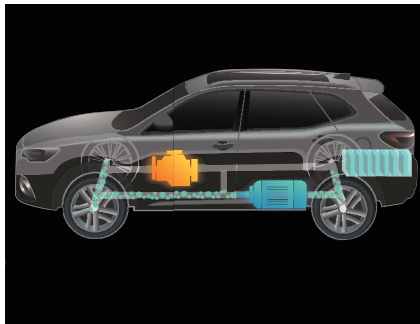

Idling Charging Mode

When the vehicle is idling, the engine is charging the high-voltage battery pack.

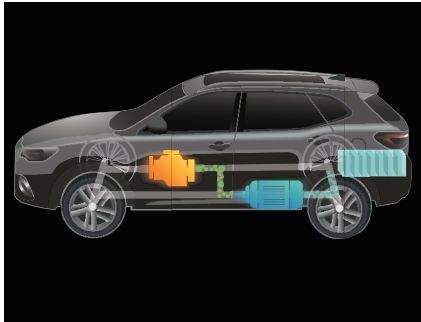

Engine Idle Assisting

The engine is idling but not charging the HV battery pack.



INSTRUMENTS AND CONTROLS

Energy Regeneration Mode

The engine is not running, the motor is recycling brake energy to charge the high-voltage battery pack.

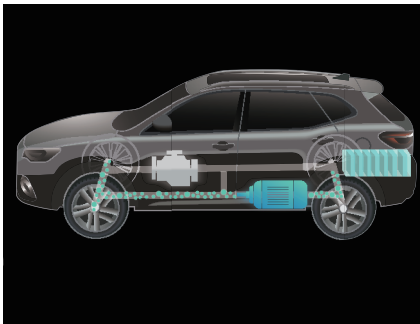

The engine is running with the motor recycling brake energy to charge the high-voltage battery pack.

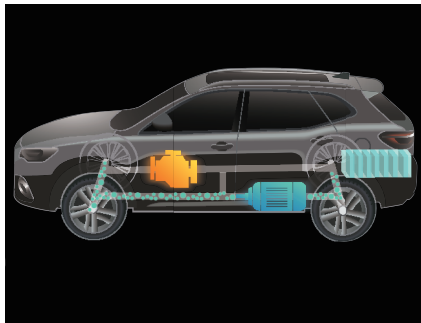

INSTRUMENTS AND CONTROLS

1

Engine Driving Mode

The vehicle is being driven by the engine only, the motor is not providing any drive.



Running Charging Mode

When the vehicle is running, the engine is driving the vehicle and charging the high-voltage battery pack.

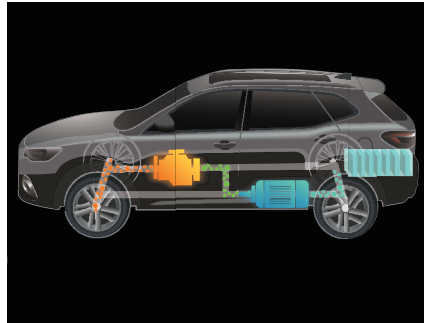

INSTRUMENTS AND CONTROLS

Warning Message

Warning messages and prompts are displayed in the information message centre in the instrument pack. Any communications are displayed in 'pop up' messages, these can be divided into the following categories:

- Operating Instruction
- System State Instruction
- System Malfunction Alert

Please follow the instructions displayed in the 'pop up' message or in the case of a warning message, please refer to the relevant section of the owners manual to follow the correct instructions.

The following are a selection of warning messages that may appear in the information message centre.

Warning Message	Procedure
Engine Coolant Temperature High	High engine coolant temperature could result in severe damage. Stop the car as soon as safety permits, shut down the power system and contact an MG Authorised Repairer immediately.
Engine Coolant Temperature Sensor Fault	Indicates that the engine coolant temperature sensor has failed. Please contact an MG Authorised Repairer immediately.
Check Engine	Indicates that a failure has occurred that may severely damage the engine, stop the car as soon as safety permits, shut down the power system and contact an MG Authorised Repairer immediately.

INSTRUMENTS AND CONTROLS

1

Warning Message	Procedure
Engine Fault	Indicates that a failure has occurred that will effect engine performance and emissions. Please contact an MG Authorised Repairer as soon as possible.
12V Battery Charging System Fault	Indicates that the 12V low-voltage battery charging system has detected a fault. Please contact an MG Authorised Repairer immediately.
Low Oil Pressure	Indicates that the oil pressure is too low, which may result in severe engine damage. Stop the vehicle as soon as safety permits and shut down the power system, check the oil level and contact an MG Authorised Repairer immediately.

Warning Message	Procedure
Ignition System Fault	Indicates that the power mode has detected a fault. Please contact an MG Authorised Repairer immediately.
Start Stop Button Fault	Indicates that the START/STOP Switch has detected a fault. Please contact an MG Authorised Repairer immediately.
Passive Entry Fault	Indicates that keyless entry function has detected a fault. Please contact an MG Authorised Repairer as soon as possible.
ABS Fault	Indicates that the ABS system has detected a fault, and the anti-lock brake function will be disabled. Please contact an MG Authorised Repairer immediately.

INSTRUMENTS AND CONTROLS

Warning Message	Procedure
Brake Fault	Indicates that a fault has been detected within the braking system, such as brake fluid low/loss or Electronic Brake-force distribution failure has occurred, stop the vehicle as soon as safety permits, shut down the power system, check the brake fluid level and contact an MG Authorised Repairer immediately.
Stability Control Fault	Indicates that SCS system has detected a fault. Please contact an MG Authorised Repairer immediately.
Traction Control Fault	Indicates that TCS system has detected a fault. Please contact an MG Authorised Repairer immediately.

Warning Message	Procedure
EPB System Fault	Indicates that EPB system has detected a fault. Please contact an MG Authorised Repairer as soon as possible.
Park Brake Force Not Enough	Indicates that the EPB system has detected a fault during parking. Please contact an MG Authorised Repairer as soon as possible.
Autohold Fault	Indicates that auto hold function has detected a fault. Please contact an MG Authorised Repairer as soon as possible.
Hill Descent Control Fault	Indicates that HDC system has detected a fault. Please contact an MG Authorised Repairer as soon as possible.

INSTRUMENTS AND CONTROLS

1

Warning Message	Procedure
EPS Performance Reduced	Indicates that the electric power steering system has a general failure and that the steering performance has been reduced. As soon as conditions permit, safely stop the vehicle and switch the vehicle power system to the OFF position. After a short while, switch the vehicle power system to the ON/RUNNING position, drive the vehicle a short distance and monitor the operation of the steering. If the message is still displayed or the steering assistance reduced, please contact an MG Authorised Repairer immediately.
EPS Assistance Failure	Indicates that the electric power steering system has failed. Please contact an MG Authorised Repairer immediately.

Warning Message	Procedure
Steering Angle Fault	Indicates that the steering angle sensor has detected a fault. Please contact an MG Authorised Repairer as soon as possible.
Steering Angle Uncalibrated	Indicates that the steering angle sensor is not calibrated. Please contact an MG Authorised Repairer as soon as possible.
ESCL Fault	Indicates that the ESCL system has detected a fault. Stop the car as soon as safety permits, shut down the power system and contact an MG Authorised Repairer immediately.
Vacuum System Fault	Indicates that the vacuum system has detected a fault. Please contact an MG Authorised Repairer immediately.

INSTRUMENTS AND CONTROLS

Warning Message	Procedure
Fuel Sensor Fault	Indicates that the fuel sensor has detected a fault. Please contact an MG Authorised Repairer as soon as possible.
Airbag Fault	Indicates that the SRS system has detected a fault, stop the car as soon as safety permits, shut down the power system and contact an MG Authorised Repairer immediately.
Power Tailgate System Fault	Indicates that the electric tailgate system has detected a fault. Please contact an MG Authorised Repairer as soon as possible.
TPMS Fault	Indicates that the tyre pressure monitoring system (TPMS) has detected a fault. Please contact an MG Authorised Repairer as soon as possible.

Warning Message	Procedure
Front Left/Front Right/Rear Left/Rear Right Tyre Sensor Battery Low	Indicates that the TPMS has detected a sensor has a low battery. Please contact an MG Authorised Repairer as soon as possible.
Park Assist System Fault	Indicates that PDC system has detected a fault. Please contact an MG Authorised Repairer as soon as possible.
Rear Drive Assist System Fault	Indicates that the rear drive assist system (RDA) has detected a fault. Please contact an MG Authorised Repairer as soon as possible.
Front Camera Failed , Driver Assistance System Unavailable	Indicates that the front camera has detected a fault. Please contact an MG Authorised Repairer as soon as possible.

INSTRUMENTS AND CONTROLS

1

Warning Message	Procedure
Front Camera Calibration Failed	Indicates that the front view camera module (FVCM) calibration has failed. Please contact an MG Authorised Repairer as soon as possible.
RADAR Calibration Failed	Indicates that the radar module calibration has failed. Please contact an MG Authorised Repairer as soon as possible.
Lane Departure Warning System Fault	Indicates that the lane departure warning system (LDW) has detected a fault. Please contact an MG Authorised Repairer as soon as possible.
Lane Keep Assist System Fault	Indicates that the lane keep assist system (LKA) has detected a fault. Please consult an MG Authorised Repairer as soon as possible.

Warning Message	Procedure
ACC System Fault	Indicates that the adaptive cruise control system (ACC) has detected a fault. Please contact an MG Authorised Repairer as soon as possible.
Auto Emergency Braking System Fault	Indicates that the auto emergency braking system (AEB) has detected a fault. Please contact an MG Authorised Repairer as soon as possible.
Pedestrian Auto Emergency Braking Fault	Indicates that the auto emergency braking system for pedestrians (AEBP) has detected a fault. Please contact an MG Authorised Repairer as soon as possible.
Forward Collision System Fault	Indicates that the forward collision warning system (FCW) has detected a fault. Please contact an MG Authorised Repairer as soon as possible.

INSTRUMENTS AND CONTROLS

Warning Message	Procedure
MSA Fault	Indicates that the Manual Speed Assist (MSA) function has failed. Please contact an MG Authorised Repairer as soon as possible.
ISA Fault	Indicates that the Intelligent Speed Assist (ISA) function has detected a fault. Please contact an MG Authorised Repairer as soon as possible.
MG Pilot System Fault	Indicates that the MG Pilot system has detected a fault. Please contact an MG Authorised Repairer as soon as possible.

Warning Message	Procedure
eCall System Fault	Indicates to the driver via a yellow SOS warning lamp that the eCall system has detected a fault and is not operating within its parameters. The SOS button LED status indicator flashes twice per second. Please contact an MG Authorised Repairer as soon as possible.
eCall System Failure	Indicates to the driver via a red SOS warning lamp that the eCall system has failed and is not capable of supporting in the event of an accident. The SOS button LED status indicator is not illuminated. Please contact an MG Authorised Repairer immediately.

INSTRUMENTS AND CONTROLS

1

Warning Message	Procedure
eCall in Progress	Indicates to the driver via a green SOS warning lamp that an emergency services call is currently in progress. The SOS button LED status indicator flashes once per second.
Auto eCall Disabled	Indicates to the driver via a red SOS warning lamp that automatic eCall service is disabled. Please contact an MG Authorised Repairer to reactivate the automatic eCall function.
Pedestrian Alert System Fault	Indicates that the pedestrian alert system has detected a fault. Please contact an MG Authorised Repairer as soon as possible.
DCDC Charge Fault	Indicates that the DCDC has detected a fault. Please contact an MG Authorised Repairer immediately.

Warning Message	Procedure
Please Service the Refueling System	Indicates that the refueling system has detected a fault. Please contact an MG Authorised Repairer as soon as possible.
HV Battery Fault	Indicates that the HV battery has detected a fault. Please contact an MG Authorised Repairer immediately.
Hybrid System Fault	Indicates that the hybrid system has detected a fault. Please contact an MG Authorised Repairer as soon as possible.
Motor Overheating	Indicates that the motor has overheated. Please contact an MG Authorised Repairer as soon as possible.
EDU Coolant Overheating	Indicates that the EDU coolant is overheated. Please contact an MG Authorised Repairer as soon as possible.

INSTRUMENTS AND CONTROLS

Warning Message	Procedure
Motor Fault	Indicates that the drive motor has detected a fault. As soon as conditions permit, safely stop the vehicle and switch the vehicle power system to the OFF position and contact an MG Authorised Repairer immediately.
Fault, Vehicle cannot start again after power off	Please contact an MG Authorised Repairer immediately.
Engine Fault, Pay Attention to SOC	Indicates that the engine has detected a fault, please pay attention to SOC. Please contact an MG Authorised Repairer immediately.
Gearbox fault, Rshifter is not supported	Indicates that the gearbox has detected a fault, and Rshifter is not supported. Please contact an MG Authorised Repairer immediately.

Warning Message	Procedure
Power is limit, Please repair the Vehicle	Power is limited. Please contact an MG Authorised Repairer immediately.
DANGER! Evacuate Vehicle Safely!	As soon as conditions permit, safely stop the vehicle and evacuate all occupants immediately, and contact an MG Authorised Repairer immediately

Warning Lights and Indicators

Some warning lamps illuminate or flash accompanied by a warning tone. Certain warning lamps will be accompanied by a momentary warning symbol and text message displayed in the information centre in the instrument pack.

Main Beam Indicator - Blue



This indicator illuminates when the headlamp high beam is turned on.

Auto Main Beam Indicator - Green



The indicator illuminates when the auto main beam function is enabled.

Dipped Beam Indicator - Green *



This indicator illuminates when the headlamp dipped beam is turned on.

Side Lamp Indicator - Green



The indicator illuminates when the side lamps are on.

Rear Fog Lamp Indicator - Yellow



The indicator illuminates when the rear fog lamps are on.

Front Fog Lamp Indicator - Green



The indicator illuminates when the front fog lamps are on.

Direction Indicator - Green



The left and right direction indicator lamps are represented by directional arrows that are located at the top of the instrument pack. When the turning signal lamp flashes, the direction indicator lamp on the corresponding

INSTRUMENTS AND CONTROLS

side also flashes. If the hazard warning lamps are operated, both direction indicator lamps will flash together. If either direction indicator lamp in the instrument pack flashes very rapidly, it indicates that the turning signal light on the corresponding side has failed.

Note: *Failure of a side repeater lamp will have no effect on the flash frequency of direction indicator lamp.*

Engine Coolant Temperature Warning - Red



When the engine coolant temperature warning lamp illuminates red, it indicates that the coolant temperature is high. If the engine coolant temperature continues to rise, the engine coolant temperature warning lamp will flash.

High engine coolant temperature could result in severe damage. Stop the vehicle and switch off the power system as soon as safety permits and contact an MG Authorised Repairer immediately.

Engine Malfunction Warning - Yellow



This lamp will illuminate if an engine fault occurs that will effect engine performance during driving. Stop the vehicle and switch off the power system as soon as safety permits and contact an MG Authorised Repairer immediately.

Engine Emissions Malfunction Warning - Yellow



This lamp will illuminate if: the fuel filler cap has been left off or is not fastened correctly, the fuel system detects a fault or the engine develops a fault that can effect performance and emissions. Where necessary check the security of the fuel filler cap. if the lamp remains illuminated, please contact an MG Authorised Repairer as soon as possible.

12v Battery Charging System Malfunction

Warning - Red



If this lamp illuminates after starting the vehicle, it indicates that the 12v battery charging system has failed. Please contact an MG Authorised Repairer immediately.

In cases of low battery power, the prompt messages will appear in the information centre. In this case, the system will limit or turn off some electrical devices, please start the vehicle to charge the battery.

Low Oil Pressure Warning - Red



If this lamp illuminates after starting the vehicle, it indicates that the oil pressure is too low, which may result in severe engine damage. Stop the vehicle as soon as safety permits and SWITCH OFF THE POWER SYSTEM IMMEDIATELY. Check the oil level (Refer to “Engine Oil Level Check and Top UP” in “Maintenance” chapter). Contact an MG Authorised Repairer immediately.

Electric Power Steering (EPS)/ Electric Steering Column Lock (ESCL) Warning - Red/Yellow



The warning lamp is used to indicate electric power assisted steering failure or electronic steering column lock failure.

If this lamp illuminates yellow, it indicates the electric power assisted steering system has a general failure and the performance is reduced. Please stop the car as soon as safety permits. If the lamp still illuminates after restarting the vehicle and driving for a short while, please contact an MG Authorised Repairer immediately.

If this lamp illuminates red, it indicates the electric power assisted steering system has a general failure relevant to steering angle sensing. Please contact an MG Authorised Repairer as soon as possible.

If this lamp illuminates red and flashes, it indicates the electric power assisted steering system has a severe failure. Please contact an MG Authorised Repairer immediately.

INSTRUMENTS AND CONTROLS

If the lamp illuminates yellow and continually flashes accompanied with an audible warning, it indicates the electric steering column lock has a failure. Please contact an MG Authorised Repairer as soon as possible. If this lamp extinguishes after flashing for a while, it indicates that the steering wheel is locked, please attempt to rotate the steering wheel to remove any adverse loads.

Tyre Pressure Monitoring System (TPMS)

Warning - Yellow



If this warning lamp illuminates it indicates that a tyre pressure is low, please check the tyre pressures.

If this lamp flashes first and then remains illuminated after a period of time, it indicates the system has detected a fault. Please contact an MG Authorised Repairer as soon as possible.

ABS Malfunction Warning Lamp - Yellow



This lamp illuminates to indicate an ABS fault. Please contact an MG Authorised Repairer as soon as possible.

If an ABS failure occurs while driving, the ABS function will be disabled while normal braking will still be available. Please contact an MG Authorised Repairer as soon as possible.

Hill Descent Control (HDC) ON/Malfunction Warning - Green/Yellow



With the HDC switch pressed, if the lamp illuminates green, it indicates the HDC system has entered the Standby mode. When the lamp flashes green, it indicates that the system is currently under the control of HDC. Press the HDC switch again, the lamp extinguishes, it indicates the HDC function is deactivated.

If the HDC system detects a fault, this lamp illuminates yellow. Please contact an MG Authorised Repairer as soon as possible.

If this lamp illuminates yellow and flashes, it indicates that the brake system has overheated and the system will be disabled.

Stability Control/Traction Control System Warning Lamp - Yellow



This lamp illuminates to indicate that a fault has been detected in the system. Please contact an MG Authorised Repairer immediately.

If this lamp flashes during driving, it indicates the system is operating to assist the driver.

Stability Control/Traction Control System OFF Warning Lamp - Yellow



If the stability control/traction control system is switched off manually, this warning lamp will illuminate.

Brake System Malfunction Warning Lamp - Red



If this lamp illuminates, it indicates a fault or issue has been detected in the brake system such as brake fluid loss or electronic braking-force distribution failure.

Please stop the vehicle as soon as safety permits, shut down the power system, check the brake fluid level (refer to "Brake Fluid Check and Top Up" in "Maintenance" section) and contact an MG Authorised Repairer immediately.

INSTRUMENTS AND CONTROLS

Seat Belt Unfastened Warning Lamp - Red



If this lamp illuminates or flashes, it indicates that the seat belt for the driver or front passenger remains unfastened.



This vehicle is equipped with rear seat belt warnings to remind you to ensure any rear seat passengers have fastened their seat belts. The dedicated warning lamp consists of the 3 sections, 1 for each rear seat position, it will illuminate red on every ignition cycle and remain illuminated until a pre-set speed is reached and after a pre-set time period. If all 3 rear seat belts are fastened this lamp will extinguish immediately. When each individual rear seat belt is fastened the colour of that particular seat belt warning lamp will change from red to grey, the other seat positions will remain illuminated red, all 3 seat belt warning lamps will extinguish after the pre-set speed is reached and the pre-set time has been surpassed.

Airbag Warning Lamp - Red



This lamp illuminates to indicate a fault in the SRS or seat belt failure has been detected. In this case, please stop the vehicle as soon as safety permits, shut down the power system immediately, and contact an MG Authorised Repairer for service at the earliest opportunity. An SRS or seat belt fault may mean the components may not be deployed in the event of an accident.

Anti-theft System Warning - Red



If no valid key is detected, this lamp illuminates red, please use the correct key or put the smart key at the bottom of the centre console cup holder. For specific position, please refer to "Alternative Starting Procedure" in "Starting & Driving" chapter.

With the START/STOP Switch in the ON/READY position, if the remote key battery is low, this lamp flashes, please replace the battery as soon as possible.

Electronic Parking Brake (EPB) / Auto Hold Status Indicator - Red/Green



If this lamp illuminates red, it indicates the EPB system is enabled. If this lamp illuminates red and flashes, it indicates that the EPB system has failed. Please contact an MG Authorised Repairer as soon as possible.

When the auto hold system is operating to assist the driver, this lamp illuminates green.

Electronic Parking Brake (EPB) System Malfunction Warning Lamp - Yellow



If an electronic parking brake system failure is detected or the system is under diagnosis, the lamp will illuminate. Please contact an MG Authorised Repairer as soon as possible.

Low Fuel Warning Lamp - Yellow



The warning lamp illuminates yellow when the fuel remaining in the fuel tank is low. If possible, please refuel before the low fuel warning lamp illuminates.

When the fuel level continues to fall, this lamp flashes. When fuel is added to the tank and the fuel level rises above the alert limit, this lamp extinguishes. If it does not extinguish, please contact an MG Authorised Repairer for service as soon as possible.

Note: *When driving on steep or rough roads while the fuel level is low, the warning lamp may illuminate.*

System Fault Messages Indicator - Yellow



This indicator is used to alert the driver to the fact that there is a warning stored in the vehicle IPK system. Please refer to "Information Centre" in this section for these failures.

INSTRUMENTS AND CONTROLS

Lane Departure Warning System Indicator - Green/Yellow



This lamp will illuminate yellow when the Lane Departure Warning function is enabled, the lamp will extinguish when the function is disabled.

This lamp will illuminate green when the Lane Departure Warning function is activated.

If the Lane Departure Warning System is not able to function normally the lamp will flash yellow and then remain on after a period of time. Please contact an MG Authorised Repairer for service as soon as possible.

For more information, please refer to “Lane Departure Warning System (LDW)” in “Starting & Driving” section.

Lane Departure Prevention System Indicator - Green/Yellow



This lamp will illuminate yellow when the Lane Departure Prevention function is enabled, the lamp will extinguish when the function is disabled.

This lamp illuminates green when the Lane Departure Prevention function is activated.

If the Lane Departure Prevention System is not able to function normally the lamp will flash yellow and then remain on after a period of time. Please contact an MG Authorised Repairer.

For more information, please refer to “Lane Departure Prevention System (LDP)” in “Starting & Driving” section.

Lane Keeping Assist System Indicator - Green/Yellow



This lamp will illuminate yellow when the Lane Keeping Assist function is enabled, the lamp will extinguish when the function is disabled.

This lamp illuminates green when the Lane Keeping Assist function is activated.

If the Lane Keeping Assist System is not able to function normally the lamp will flash yellow and then remain on after a period of time. Please contact an MG Authorised Repairer.

For more information, please refer to “Lane Keeping Assist System (LKA)” in “Starting & Driving” section.

MG Pilot System Indicator - Green/Yellow



This lamp will illuminate yellow when the MG Pilot function is enabled, the lamp will extinguish when the function is disabled.

This lamp illuminates green when the MG Pilot function is activated.

If the MG Pilot System is not able to function normally the lamp will flash yellow and then remain on after a period of time. Please contact an MG Authorised Repairer as soon as possible.

For more information, please refer to “MG Pilot System” in “Starting & Driving” section.

Forward Collision Assist System (FCW/AEB/AEBP) Indicator - Yellow



This lamp will illuminate yellow when one of the forward collision assist system (FCW/AEB/AEBP) functions is disabled.

When all of the forward collision assist system (FCW/AEB/AEBP) functions are enabled, if the indicator remains on, it indicates the system is not able to function normally. Please contact an MG Authorised Repairer as soon as possible.

INSTRUMENTS AND CONTROLS

For more information, please refer to “Forward Collision Warning System (FCW)” and “Automatic Emergency Braking System (AEB) and Automatic Emergency Braking System for Pedestrians (AEBP)” in “Starting & Driving” section.

Manual Speed Assist System Indicator - Green/Yellow



This lamp will illuminate yellow when the Manual Speed Assist function is enabled, the lamp will extinguish when the function is disabled. For specific operation, please refer to “Speed Assist System (SAS)” in “Starting & Driving” section. If the current speed of the vehicle is above the maximum value allowed by the system the vehicle remains in the stand by state and the lamp will illuminate yellow.

This lamp illuminates green when the Manual Speed Assist function is activated.

If the Manual Speed Assist System is not able to function normally the lamp will flash yellow and then extinguish.

Please try to reinstate this function. If this function cannot be switched on, please contact an MG Authorised Repairer as soon as possible.

For more information, please refer to “Speed Assist System (SAS)” in “Starting & Driving” section.

Intelligent Speed Assist System Indicator - Green/Yellow



This lamp will illuminate yellow when the Intelligent Speed Assist function is enabled, the lamp will extinguish when the function is disabled.

This lamp illuminates green when the Intelligent Speed Assist function is activated.

If the Intelligent Speed Assist System is not able to function normally the lamp will flash yellow and then extinguish. Please try to reinstate this function. If this function cannot be switched on, please contact an MG Authorised Repairer as soon as possible.

For more information, please refer to “Speed Assist System (SAS)” in “Starting & Driving” section.

Manual Speed Assist System Speed Indicator



This lamp will illuminate when the Manual Speed Assist function is enabled. 'NNN' denotes the current setting value of the speed limit. If there is no speed limit value the lamp will display '—'.

Speed Limit Sign Indicator - Red



'NNN' denotes the speed value of speed limit sign currently recognised. If there is no speed limit value available the lamp will display '—'.

When the Intelligent Speed Assist function is activated or SLIF Warning function is enabled, the lamp will flash if the speed limit value is exceeded, please slow down.

Speed Limit Sign Additional Information Warning Lamp- Yellow



This lamp will illuminate when the speed limit sign currently recognised has additional information. Please pay attention to it.

National Speed Limit Sign Indicator



When the national speed limit sign is identified, and the speed limit information function or intelligent speed assist function is enabled, this lamp illuminates.

For more information, please refer to “Speed Assist System (SAS)” in “Starting & Driving” section.

INSTRUMENTS AND CONTROLS

Adaptive Cruise Control System Indicator - Yellow/Green



If the Adaptive Cruise function is enabled, the Adaptive Cruise Control System will enter the standby state, the lamp illuminates yellow.

When the Adaptive Cruise Control System operates, the lamp will illuminate green, this indicates that the Adaptive Cruise Control System is activated.

Adaptive Cruise Control System Malfunction Indicator Lamp - Yellow



This lamp will illuminate if an Adaptive Cruise Control System fault is detected. Please contact an MG Authorised Repairer as soon as possible.

Rear Drive Assist System Indicator -Yellow



If the rear drive assist system is turned off, this lamp illuminates with prompt messages.

If the rear driver assist sensors are obscured, this lamp illuminates with prompt messages.

When rear drive assist system detects a fault, this lamp illuminates with prompt messages. Please contact an MG Authorised Repairer as soon as possible.

Refer to "Rear Driver Assistance System" in "Starting and Driving" chapter for more information.

eCall SOS Indicator - Red/Yellow/Green



If the system is ready and an emergency services call (eCall) is in progress, the indicator illuminates green.

If the system is still capable of sending out a vehicle information message to the call centre, but other eCall capabilities are limited due to a fault in the system, the indicator will illuminate yellow. If the eCall system has

failed and not operational, the indicator illuminates red. If the yellow or red indicator is illuminated permanently after system self-test, please contact an MG Authorised Repairer immediately.

Particulate Filter Warning Lamp - Yellow



When this lamp illuminates yellow, it indicates that the particulate filter requires regeneration. Please drive the vehicle above 50 mph until the light is no longer illuminated, and then normal usage can be resumed.

Note: *During particulate filter regeneration the engine will run unevenly and at reduced power, this will cease after a successful regeneration.*

When this lamp flashes, it indicates that the particulate filter is full. Please contact an MG Authorised Repairer immediately. Please note if the warning is ignored, the vehicle will enter a reduced performance mode and may subsequently be immobilised.

Please refer to “Catalytic Converter and Particulate Filter” in “Starting & Driving” section.

READY Indicator - Green



This lamp is used to indicate that the vehicle is ready for driving.

Charging Status Indicator - Yellow



This lamp will illuminate when the vehicle is connected to a charge point, it will remain on during charging and extinguish after charging is completed

Charging Connection Indicator - Red



This lamp will illuminate when the vehicle is connected to a charge point.

INSTRUMENTS AND CONTROLS

Power System Malfunction Warning - Red/Yellow



If this lamp illuminates yellow, it indicates that the vehicle has detected a fault and power is limited. Please contact an MG Authorised as soon as possible.

If this lamp illuminates red, it indicates that the vehicle has detected a severe fault. Please stop the vehicle as soon as safety permits, turn off the START/STOP Switch and contact an MG Authorised immediately.

Motor Overheat Warning - Red



This lamp will illuminate if the motor temperature is too high. Please contact an MG Authorised as soon as possible.

Motor Malfunction Warning - Red



If a fault or failure is detected in the motor or the power electronic box of electric drive system, this lamp

will illuminate. Please stop the vehicle as soon as safety permits, turn off the START/STOP Switch and contact an MG Authorised immediately.

High-voltage Battery Pack Low Battery Warning - Yellow



This lamp will illuminate when the high voltage battery charge is low, if the voltage continues to drop, this lamp will flash. Where possible please charge the high voltage battery before this lamp enters the flashing stage.

High-voltage Battery Pack Disconnection Warning - Yellow



When the high-voltage battery pack is connected, this lamp will not illuminate. This lamp will only illuminate when the high voltage battery is disconnected or isolated.

High-voltage Battery Pack Malfunction Warning

- Red



This lamp will illuminate if a fault is detected or the high voltage battery fails. Please contact an MG Authorised Repairer immediately.

This lamp will flash if the high voltage battery temperature is too high. Please stop the car as soon as safety permits, switch the vehicle power system to the OFF position, and leave the vehicle immediately. Contact an MG Authorised Repairer at the earliest opportunity.

Driving Power Limited Warning - Yellow



This lamp will illuminate if the vehicle power has been reduced.

INSTRUMENTS AND CONTROLS

Lights and Switches

Master Light Switch

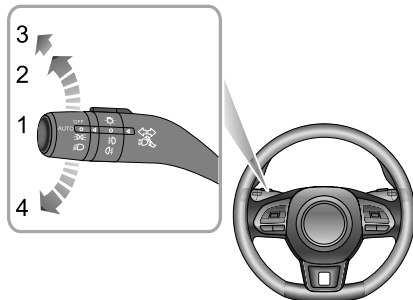

- 1 AUTO Lamp
- 2 Side Lamp and Switch Illumination
- 3 Dipped Headlamps
- 4 Lights Off

AUTO Lamp

When the START/STOP Switch is in the ACC position, the auto lighting system defaults to the ON position (1). The AUTO lighting system will automatically switch the side lamps and switch illumination on and off according to the intensity of current ambient light.

With the START/STOP Switch in the ON/READY position, the AUTO lighting system will automatically switch the side lamps, switch illumination and dipped beam headlamps on and off according to the intensity of current ambient light.

Side Lamp and Switch Illumination

Rotate the master lighting switch to position 2 to operate the side lamps and switch illumination. With the START/STOP Switch in the OFF position if the lighting switch is in position 2 and the driver's door opened an audible warning will sound to alert the driver, the side lamps will remain on.

Dipped Headlamps

When the START/STOP Switch is in the ON/READY position rotate the master lighting switch to position 3

to operate the dipped beam headlamps , side lamps and switch illumination.

Lights Off

Rotate the master lighting switch to position 4, this will switch off all lamps, releasing the switch will allow it to return to the AUTO switch position.

Daytime Running Lamps

The daytime running lamps illuminate automatically when the START/STOP Switch is in the ON/READY position.

Follow Me Home

After the START/STOP Switch is turned off, pull the lighting lever towards the steering wheel. This will enable the Follow Me Home function, dipped beam headlamps and rear lamps will illuminate depending upon the vehicle configuration.

Find My Car

After the vehicle has been left in a locked condition for several minutes, pressing the lock button again on the

remote key will enable the Find My Car function. This function will identify the car by means of an audible and visual alert. Pressing the Lock button on the remote key again will suspend this operation. Pressing the Unlock button on the remote key will cancel this operation.

Headlamp Levelling Manual Adjustment

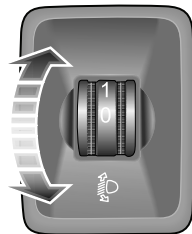

INSTRUMENTS AND CONTROLS

Position 0 is the initial position of the headlamp levelling adjustment switch. The headlamp levelling can be adjusted as per the following table according to the vehicle load.

Location	Load
0	Driver, or driver & front passenger
1	All the seats occupied with no load
2	All the seats occupied plus an evenly distributed load in the boot
3	Driver only, plus an evenly distributed load in the boot

Direction Indicator/Master Lighting Switch



Take care not to dazzle oncoming vehicles when driving using main beam headlamps.

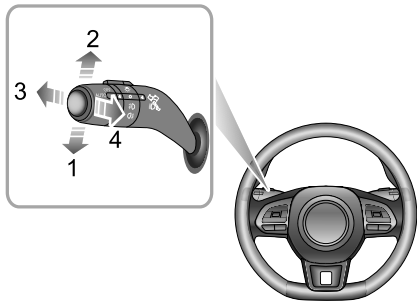

Direction Indicators

Move the lever down to indicate a LEFT turn (1). Move the lever up to indicate a RIGHT turn (2). The corresponding

GREEN indicator lamp in the instrument pack will flash when the turn signal lamps are working.

Rotating the steering wheel will cancel the indicator operation (small movements of the steering wheel may not operate the self cancelling). To indicate a lane change, move the lever briefly and release, the indicators will flash three times and then cancel.

Main/Dipped Beam Headlamps Switching

With the START/STOP Switch in the ON/READY position , the master lighting switch turned to position 3, or the auto function has switched the lights on, push the lever (3) towards the instrument panel to turn the headlamp main beams on. The main beam indicator lamp in the instrument pack will illuminate, press the lever (3) again to switch the headlamps to dipped beam.

Main Beam Flash

To briefly flash the main beam on and off, pull the lever (4) towards the steering wheel and then release.

INSTRUMENTS AND CONTROLS

Smart Main Beam System



The smart main beam system serves only as an auxiliary function. The driver must check the status of the front lamps, and turn on the front lamps when necessary.

For example: The main beam may not be turned off automatically in the following cases, thus manual switching between the main beam and dipped beam is required:

- The windscreen is dirty, broken or obstructed by other objects blocking the view of the sensor.*
- The lamps of other vehicles are missing, damaged, obscured or partially obscured or cannot be detected for some other reasons.*
- The lamps of other vehicles are obscured or partially obscured by smoke, fog, snow, water spray or any other conditions that effect visibility.*

- When pedestrians, non-motor vehicles and other objects with no obvious light or reflected light are encountered.*
- When the headlamps and tail lamps of other vehicles cannot be detected due to the sensor view being impaired due undulating road conditions such as bends, dips or hills.*
- When the car is driving on a winding road or mountainous road.*

In any of the aforementioned conditions (but not limited to) smart main beam operation may be suspended, it will be necessary to operate the main beam lamps manually.

The smart main beam system uses the front view camera to detect the light intensity of the vehicle ahead. The main beam lamps can be switched on or off automatically by the system when the surroundings are dark and no light detected. The smart beam function can be switched on/off via the infotainment system settings - settings - comfort and convenience.

To enable the smart main beam system, the following conditions must met:

- 1 The master lighting switch must be in the 'Auto' position and the dipped beam lamps switched on via automatic control.
- 2 The vehicle is running and the speed is above 25mph.
- 3 The front/rear fog lamps are NOT switched on.

When the smart main beam system is enabled, the auto main beam indicator on the instrument pack illuminates.

The main beam lamps will remain on under automatic control until any of the following conditions occur:

- The system detects the headlamps of approaching vehicles.
- The system detects the tail lamps of vehicles ahead.
- The surroundings become bright enough not to require main beam.
- The vehicle speed drops below the 25mph threshold.

The system will temporarily suspend the smart main beam function once the following conditions are met:

With the smart main beam system enabled, instantaneously pull the lighting lever towards the steering wheel, the smart main beam function will be temporarily suspended, it will automatically be re-instated when the switch lever is released.

Note: Continuously operating the main beam switch within 2 seconds will retain the main beam lamps under automatic control, and the system will not exit the smart main beam function.

IMPORTANT

The smart main beam function uses data from the front view camera, always keep the windscreen clean and free from residue in this area to maintain optimum performance of this system. Any damage in this area, such as stonechips must be repaired at the earliest convenience.

INSTRUMENTS AND CONTROLS

Fog Lamp Switch



Fog lights should only be used when visibility is below 100m - other road users could be dazzled in clear conditions.

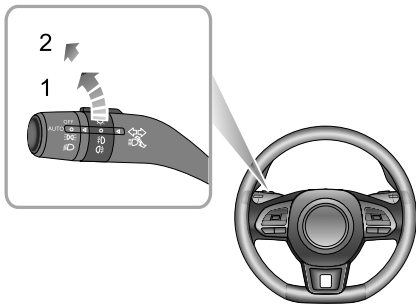

Front Fog Lamps

With the START/STOP Switch in the ON/READY position and the side lamps on, rotate the fog lamp switch to

position 1 to turn on the front fog lamps. The indicator illuminates in the instrument panel when the front fog lamps are on.

Rear Fog Lamps

With the START/STOP Switch in the ON/READY position and the front fog lamps turned on, rotate the fog lamp button to position 2 to turn on the rear fog lamps, release the switch to return to position 1. The indicator illuminates on the instrument panel when the rear fog lamps are on.

Hazard Warning Lamps

Press the hazard warning lamp button  to operate the hazard warning lamps. All turn signal lamps and direction indicator lamps will flash together. Press the button again to switch off the hazard warning lamp. All turn signal lamps and direction indicator lamps will stop flashing. For the location of hazard warning lamp, refer to the illustration of "Hazard Warning Devices" under "Emergency Information".

Wipers and Washers

Front Windscreen Wiper Controls

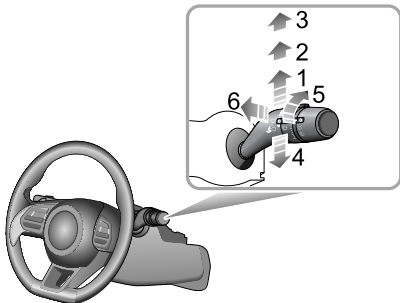

The wipers and washers will only operate when the START/STOP Switch is in the ON/READY position.. Operate the lever to select different wiping modes:

- Intermittent wipe (1)
- Slow speed wipe (2)

- Fast speed wipe (3)
- Single wipe (4)
- Rain sensor sensitivity adjustment (5)
- Programmed wipe (6)

Intermittent Wipe

By pushing the lever up to the Intermittent wipe position (1), the wipers will operate automatically. The interval between the Intermittent wipes can be increased/decreased by rotating the switch (5).

The vehicles are equipped with a rain sensor fitted to the interior rearview mirror base to detect varying amounts of water on the outside of the windscreen. With automatic wipe, the vehicle will adjust the wiping speed according to the signals provided by rain sensor. Rotate the switch (5) to adjust the sensitivity of rain sensor. As the sensitivity increases, the wiping interval decreases.

Note: Immediately operating the wiper one time can be achieved by increasing the sensitivity of rain sensor. If the rain sensor detects continuous rainwater, the wipers will keep working. When it is not raining, it is recommended to switch off automatic wipe.

INSTRUMENTS AND CONTROLS

Slow Speed Wipe

By pushing the lever up to the slow speed wiping position (2), the wipers will operate slowly.

Fast Speed Wipe

By pushing the lever up to the fast speed wiping position (3), the wipers will operate at fast speed.

Single Wipe

Pressing the lever down to the single wiping position (4) and releasing will operate a single wipe. If the lever is held down (4), the wipers will operate continuously until the lever is released.

Note: *When the car is stationary, if the bonnet is opened, the front wiper/washer operation will be disabled.*

IMPORTANT

- Avoid operating the wipers on a dry windscreen.
- In freezing or extremely hot conditions, make sure that the wiper blades are not frozen or adhered to the windscreen.
- In winter, remove snow or ice from around the wiper arms and blades, including the wiped area of the screen.

Programmed Wipe

Pulling the lever toward the steering wheel (6) will operate the front windscreen washers. After a short delay, the wipers will commence operating in conjunction with the washers.

Note: *The wipers continue operating for a further three wipes after the lever is released. After several seconds, there will be a further wipe to remove any fluid draining down the screen.*

IMPORTANT

If the washers fail to deliver the screen wash solution (dirt or ice may have blocked the jets), release the lever immediately. This will prevent the wipers from operating, and the consequent risk of visibility being impaired by dirt smearing across the unwashed windscreen.

Rear Windscreen Wiper Controls

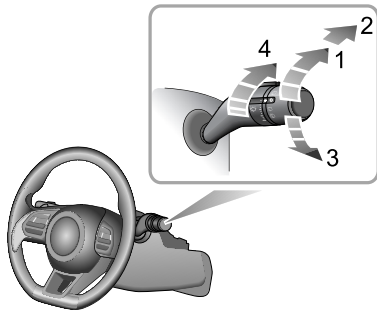

The rear wipers and washers will only operate when the START/STOP Switch is in the "ON/READY" position. Rotate the rear window wiper switch to your desired selection:

- Intermittent wipe (1)
- Wash and wipe (2)
- Wash and wipe (3)

INSTRUMENTS AND CONTROLS

- Wipe interval adjustment (4)

Intermittent position

If the rear wiper switch is rotated to intermittent wipe (1), the rear wiper will operate. It will complete 3 continuous wipes before changing to intermittent mode. The time period between the wipes can be increased/decreased via the switch (4).

Wash and wipe

Rotate the rear window wiper switch to wash and wipe (2) position and hold, the rear window wiper and washer will operate, the rear window wiper wipes quickly. release the switch allowing it to return to intermittent wipe (1), the rear window washer will stop operating.

Rotate the rear window wiper switch to wash and wipe (3) and hold, the rear window wiper and washer will operate. release the switch allowing it to return to OFF position, the rear window washer will stop operating, and the rear window wiper wipes for 3 times, after several seconds, the wiper will wipe once more to remove the washer fluid on the windscreen.

Note: *When the tailgate is opened, rear wiper operations will be disabled.*

Note: *When the windscreen wipers are switched on, if Reverse gear is selected , the rear window wiper will operate.*

Steering System

Adjustment of Steering Column



DO NOT attempt to adjust the height or angle of the steering column while the car is in motion. This is extremely dangerous.

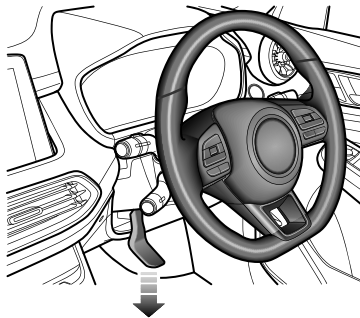

To adjust the angle or height of the steering column to suit your driving position:

- 1 Fully release the locking lever.
- 2 Hold the steering wheel in both hands and tilt the steering column up or down to move the wheel into the most comfortable position.
- 3 Push or pull the steering wheel towards or away from the body.
- 4 Once a comfortable driving position has been selected, pull the locking lever fully up to lock the steering column into its new position.

INSTRUMENTS AND CONTROLS

Electric Power Steering



If the electric power steering fails or cannot operate the steering will appear very heavy, this will affect driving safety.

The electric power steering system only works when the vehicle is started. The system operates via a motor with assistance levels automatically adjusted based on vehicle speed, steering wheel torque and steering wheel angle.

IMPORTANT

Holding the steering wheel on full lock for long periods will result in a reduction in power assistance causing a heavier feel to the steering for a short period of time.

Electric Power Steering (EPS) Warning Lamps

See "Warning Lights and Indicators" under the "Instruments and Controls" section.

If the battery has been disconnected for any reason, upon reconnection the warning lamp will illuminate yellow.

Movement of the steering wheel from lock to lock will initialise the system and the lamp will extinguish.

Horn



Press the horn button area on the steering wheel (as indicated by the arrow) to operate the horn.

Note: *The vehicle horn press and the driver's airbag are located in close proximity on the steering wheel. The illustration shows the position of the horn (indicated by arrow), please ensure that you press*

in this area to avoid any potential conflict with the operation of the airbag.

IMPORTANT

To avoid possible SRS issues, please do not press with excessive force or hit the airbag cover when operating the horn.

INSTRUMENTS AND CONTROLS

Rearview Mirrors

The vehicle is fitted with rear view mirrors, these consist of a door mirror fitted to each door and a centrally mounted interior mirror. Rear view mirrors reflect situations directly behind or on both sides of the vehicle thus expanding the driver's field of vision.

The rearview mirrors are safety-critical parts. Proper use and reasonable mirror angle adjustment can improve the driver's driving safety and comfort.

Exterior Door Mirrors

Note: Objects viewed in exterior door mirrors may appear further away than they actually are.

The mirrors can be electrically folded back towards the side windows into a 'park' position to enable the car to negotiate narrow openings and avoid collisions.

In addition to the folding function, the mirror angle of the exterior door mirrors can be adjusted electronically and also heated.

Mirror Glass Heating

The door mirrors have integral heating elements which disperse ice or mist from the glass. The heating elements operate while the Heated Rear Window  is switched on.

Note: The heating elements of rear window and mirror will only work when the engine/power system is running.

Power Folding

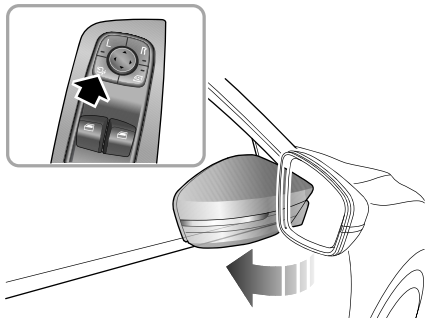

Pressing the switch (arrowed) on the combination switch in the driver side switch panel will electrically fold the exterior door mirrors. Pressing this switch again will restore the mirrors to their original position.

While unlocking/locking the vehicle, the exterior door mirrors will be deployed/folded automatically. This

function can be set in the relevant interface on the infotainment display.

Note: *Electrical folding door mirrors that have been moved from their positions by manual or accidental means must be reset by operating the folding switch to completely fold and unfold the mirrors one time.*

Electric Adjustment of Mirror Glass

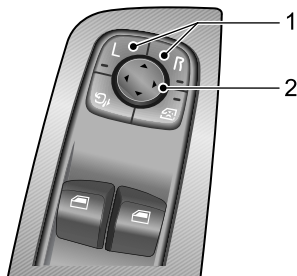

INSTRUMENTS AND CONTROLS

- Press the left (L) or right (R) switch (1) to select the left or right exterior door mirror. The indicator lamps within the switches (1) will illuminate when selected.
- Press one of the 4 arrows of the circular switch (2) to adjust the angle of the exterior door mirror.
- Press the L or R switch (1) again, the corresponding indicator lamp will extinguish, and the mirror adjustment operation will be stopped. This is to avoid accidental adjustment of mirror angle once adjustments has been made.

IMPORTANT

- Exterior door mirrors are operated by electrical motors. Operating them directly by hand may damage the internal components.
- Washing or flushing exterior door mirrors with high pressure water jets or car washes may result in electrical motor failure.

Puddle Lamp

Puddle lamps are located within the lower half of the door mirrors. For information on puddle lamp operation

please refer to "Lighting and Switches" in "Instruments and Controls" chapter.

Automatic Anti-dazzle Interior Rearview Mirror



When the START/STOP Switch is in the ON/READY position, the automatic anti-dazzle function is switched on automatically. When a following vehicle's headlamps could dazzle the driver, the light sensor activates the anti-dazzle function.

The automatic anti-dazzle function can be inhibited if:

- The light from the vehicle behind is not seen by the light sensor on the mirror.

- Reverse gear is selected.

Note: *Attaching film or objects on the rear window may have influences on the function of the automatic anti-dazzle function.*

INSTRUMENTS AND CONTROLS

Sunvisor



The vanity mirror on the driver side should only be used when the car is stationary.

Sunvisor (1) and vanity mirrors (2) are arranged on the roof ahead of both the driver and the front passenger. Certain models are fitted with vanity mirror lights (4) depending on the vehicle configuration.

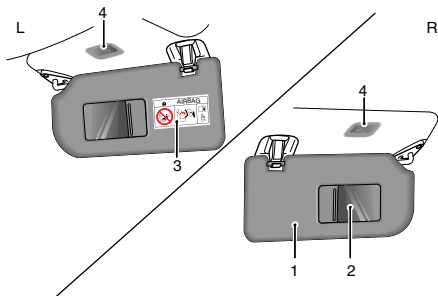

Pull the sunvisor downward to use the vanity mirror. If the roof has vanity mirror lights, the vanity mirror light is switched on when the cover is opened, and it is switched off when the cover is closed.

Note: Warnings and instructions on the use of a child restraint (3) are attached to both sides of the passenger sunvisor.

NEVER use rearward facing child restraints on a seat protected by an ACTIVE AIRBAG in front of it, DEATH or SERIOUS INJURY to the CHILD can occur. Refer to 'Disabling the Passenger Airbag'.

Windows

Power Operated Window Switch

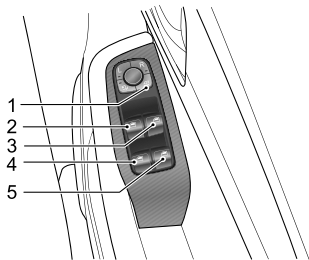

- 1 Rear Window Isolation Switch
- 2 Front Left Window Switch
- 3 Front Right Window Switch
- 4 Rear Left Window Switch
- 5 Rear Right Window Switch

Window Operation



Ensure children are kept clear when raising or lowering a window. Improper use or activation of the electric windows by children could cause serious harm or even death. It is the responsibility of the driver and adult passengers to ensure that when carrying children the necessary steps are taken to isolate the window operation. This should include switching off the ignition and removing the smart key from the vehicle when children are left alone in the vehicle.

Press the switch (2 ~ 5) to lower the window, and pull the switch to raise the window. Release the switch, the window will stop moving (unless in "one-touch" mode).

Note: *The front and rear passenger windows can also be operated by individual window switches, mounted on each door. The rear window switches will not function if the rear window isolation switch on the driver door has been activated.*

INSTRUMENTS AND CONTROLS

Note: *When the START/STOP Switch is in the ACC or ON/READY position, the power windows can be operated (doors should be closed).*

Rear Window Isolation Switch

Press the switch (1) to isolate the rear window controls (an indicator lamp in the switch illuminates), and press again to restore control.

Note: *It is recommended that you ISOLATE the rear window switches when carrying children.*

One Touch Down

The window switches (2 ~ 5) are 2 stage switches, short press to the second stage, the window will enter one touch mode and automatically fully open. When the window is moving down, its movement can be stopped at any time by pressing the switch again.

One Touch Up with Anti-Trap

The window switches (2 ~ 5) have the One Touch Up function. Briefly pull up the window control switch to

the second stage, the corresponding window automatically ascends to fully closed. Window movement can be stopped at any time by operating the switch again.

The 'Anti-Trap' function is a safety feature which prevents the window from fully closing if an obstruction is sensed. In this case, the window will move down so that the obstacle can be taken out.

Note: *DO NOT operate the power window controls continuously several times in a short time frame, in some cases the power window controls may be disabled to protect the motor. If this occurs, please wait a few seconds until the motor cools down.*

Note: *If there is a power interruption during lifting and lowering of the window, One Touch Up and Anti-Trap mode may be not operational, in this case, fully open the window, then raise the window to the fully closed position by lifting the switch briefly and consecutively. When the window is fully closed, hold the switch in the close position for a further 5 seconds . One Touch Up and Anti-Trap mode will be resumed.*

"Lazy Lock" Function

The "Lazy Lock" function can open or close all the windows by using the remote key from outside the vehicle as long as it is within detection range.

Press and hold the remote key unlock button until the windows start to open, release the unlock button, all windows will open fully. With the windows open, press and hold the remote key lock button until the windows start to close, release the lock button, the windows will completely close.

INSTRUMENTS AND CONTROLS

Sunroof *

The sunroof consists two pieces of glass and one sunshade. The front glass can be opened by sliding or tilting, the rear one is fixed and cannot be opened, and the sunshade can slide open.

Instructions



DO NOT allow passengers to lean out of an open sunroof whilst the vehicle is in motion. Injuries may occur from objects such as tree branches.



Safety of the vehicle occupants must be observed at all times. DO NOT allow limbs to be placed in the moving path of the sunroof at any time, injury may occur.

- Avoid fully opening the sunroof during rain showers.
- It is advised not to open the sunroof at high speeds.
- Where possible, please clean any residual water or raindrops off the sunroof prior to opening. Failure to do so may result in water entering the car.

- DO NOT use abrasive materials to clean the sunroof glass. Use alcohol based solvent.
- DO NOT hold the operating switch in the open/close position for any length of time after operation is complete, this could damage the electrical components.
- Clean the sunroof regularly to maintain operation and performance. Visit an MG Authorised Repairer for service as required.

Sunroof Operation

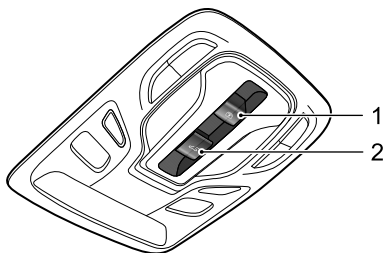

When the START/STOP Switch is set to ACC or ON/READY, you can operate the sunroof.

Switch 1 is used to operate the sunroof sunshade, and switch 2 is used to operate the sunroof glass. The method by which the sunroof will open function is identified by the icons on the switches.

Sunroof Glass Operation

Open the Sunroof Glass by Tilting

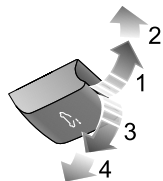

Push the sunroof glass switch upward to the 1st position (1) and hold, the sunroof will tilt open. You can stop the movement of the sunroof at any time by releasing the switch. Push the glass switch with slightly harder force to move the switch to its 2nd position (2) and then release, the sunroof will automatically open completely.

Close the Sunroof Glass by Tilting

Pull the sunroof glass switch downward to the 1st position (3) and hold, the sunroof will close. You can stop the movement of the sunroof at any time by releasing the switch. Pull the glass switch with slightly harder force to move the switch to its 2nd position (4) and then release, the sunroof will automatically close completely.

INSTRUMENTS AND CONTROLS

Open the Sunroof Glass by Sliding

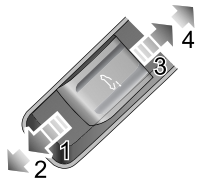

Push the sunroof glass switch backward to the 1st position (3) and hold, the sunroof will slide open. You can stop the movement of the sunroof at any time by releasing the switch. Push the glass switch backward with slightly harder force to move the switch to its 2nd position (4) and then release, the sunroof will automatically open fully. You can stop the movement of the sunroof at any time by pushing the switch backward again.

Close the Sunroof Glass by Sliding

Push the sunroof glass switch forward to the 1st position (1) and hold, the sunroof will close. You can stop the movement of the sunroof at any time by releasing the

switch. Push the glass switch forward with slightly harder force to move the switch to its 2nd position (2) and then release, the sunroof will automatically close. You can stop the movement of the sunroof at any time by pushing the switch forward again.

Sunroof Sunshade Operation

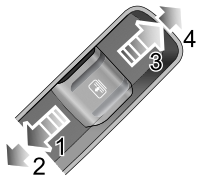

Open the Sunshade

Push the sunroof sunshade switch backward to the 1st position (3) and hold, the sunshade will slide open. You can stop the movement of the sunshade at any time by releasing the switch. Push the sunshade switch backward with slightly harder force to move the switch to its 2nd position (4) and then release, the sunshade will automatically open

fully. You can stop the movement of the sunshade at any time by pushing the switch backward again.

Close the Sunshade

Push the sunroof sunshade switch forward to the 1st position (1) and hold, the sunshade will close. You can stop the movement of the sunshade at any time by releasing the switch. Push the sunshade switch forward with slightly harder force to move the switch to its 2nd position (2) and then release, the sunshade will automatically fully close. You can stop the movement of the sunshade at any time by pushing the switch forward again.

Note: If the vehicle is to be parked in direct sunlight for a length of time it is recommended that the sunshade be closed to protect the interior trim components from damage, and to help regulate the in car temperatures.

Anti-pinch Function

The sunroof and sunshade feature an “Anti-Pinch” function, this is a safety feature which prevents the sunroof or sunshade from fully closing whilst in the automatic mode if an obstruction is sensed - if this

happens the sunroof/sunshade will open slightly to allow the obstruction to be removed.

Forcibly Closing the Sunroof (over-riding the anti pinch)

To forcibly close the sunroof glass after an anti-pinch intervention, gently slide the glass switch forwards to the 1st position within 5 seconds and hold in position until the sunroof glass is fully closed.

Note: The anti pinch function is suspended during this operation.

Forcibly Closing the Sunshade(over-riding the anti pinch)

To forcibly close the sunshade that has reopened due to activation of anti-pinch function: gently slide the sunshade switch forwards to the 1st position within 5 seconds and hold it until the sunshade closes fully.

Note: The anti pinch function is suspended during this operation.

INSTRUMENTS AND CONTROLS

Linkage between Sunshade and Sunroof Glass

To prevent the sunshade from being exposed, the sunshade will move together with the sunroof glass as one unit when the sunroof is opened. To close the sunshade, please close the sunroof glass first.

Sunroof Initialisation

In the event of a power failure or battery disconnection when the sunroof glass or sunshade is in motion, the sunroof/sunshade will require initialisation when the power is restored.

To carry out the sunroof glass initialisation operation:

Fully close the glass -gently slide the switch forward to the 2nd position and hold in position for 10 seconds. The sunroof will open a preset amount and stop, it will then close automatically - the sunroof glass is then initialised. During the whole process, the switch must remain in the 2nd position.

To carry out the sunshade initialisation operation:

Fully close the sunshade -slide the close switch forward to the 2nd position and hold in position for 10 seconds.

The sunshade will open a preset amount and stop, it will then close automatically - the sunshade is then initialised. During the whole process, the switch must remain in the 2nd position.

Thermal Protection

To prevent the sunroof glass motor and the sunshade motor from being overheated and damaged, the motors are designed with a thermal protection function, any opening or closing operation whilst in the thermal protection state will not move the sunroof. After the motor has cooled down and exits the thermal protection state, the sunroof can be operated until the next thermal protection event.

"Lazy Lock" Function

"Lazy Lock" function can open or close the sunroof from outside the vehicle.

Press and hold the remote key unlock button for several seconds until the sunroof glass and sunshade start to open, then release the button, the sunroof will continue to open until it is fully opened; with the sunroof open, press and

hold the remote key lock button for several seconds until the sunroof glass and sunshade start to close, then release the button, the sunroof will continue to close until it is fully closed.

INSTRUMENTS AND CONTROLS

Interior Light

Front Interior Lamp

According to different configurations of the vehicles, the front interior lamp may feature bulb or LED configurations.

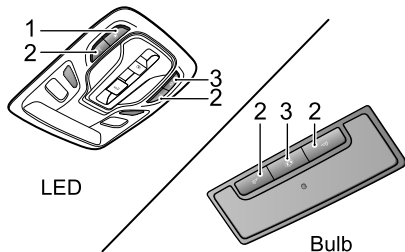

- 1 Main Manual Control Switch of Front/Rear Interior Lamps
- 2 Manual Control Button of Corresponding Front Interior Lamp
- 3 Automatic Control Button

Press switch 1 to turn on the front and rear interior lamps, press again to turn off.

Press either of the buttons 2 to turn on a corresponding front interior lamp, press again to turn off.

In addition to the manual control of the interior lamps, some operating conditions will activate an automatic control function. Press button 3 to turn on automatic control, press again to release the button, and turn off the automatic function.

When the automatic control function is enabled, the front and rear interior lamps illuminate automatically if any of the following actions are carried out:

- The car is unlocked.
- Any door is opened.
- When the vehicle light sensor detects that the ambient light level is low or the side lights have been illuminated within 30 seconds, the interior light will operate when the START/STOP Switch is set to OFF.

Note: *If a door is open for more than 15 minutes, the interior lamps will be switched off automatically to avoid battery drain.*

Rear Interior Lamp *

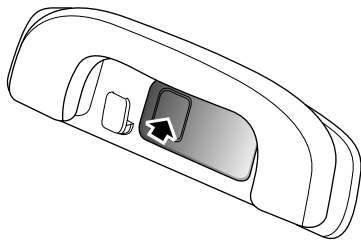

Vehicles equipped with LED front interior lamp are equipped with LED rear interior lamps.

The rear courtesy lights are located on the left and right sides of interior roof panel. Press the lamp lens as indicated in the diagram to switch on the rear courtesy lights, press it again to switch off the lights.

Ambient Lamps *

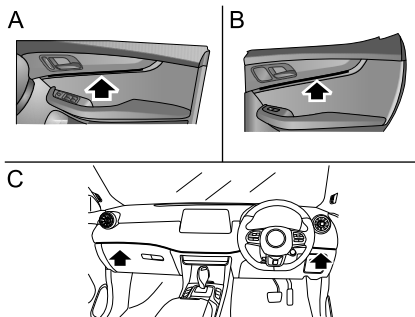

Ambient lamps are fitted on certain models to create a comfortable atmosphere inside the car. The control of the ambient lamps can be set in the infotainment system. Ambient lamps are provided on the front door interior trim panel (A), rear door interior trim panel (B) and fascia panel (C).

INSTRUMENTS AND CONTROLS

Power Socket



Please ensure the socket lid is inserted when the 12V power socket is not in use. This will ensure no debris or foreign objects enter the socket preventing its use or cause short circuits.



The voltage of the 12V power socket is 12 volt, and the power rating is 120 watt, please DO NOT use the electrical appliance with its power exceeding the rating.



Extended use of the accessory power socket and USB socket when the engine is switched off will cause premature discharging of the vehicle battery.

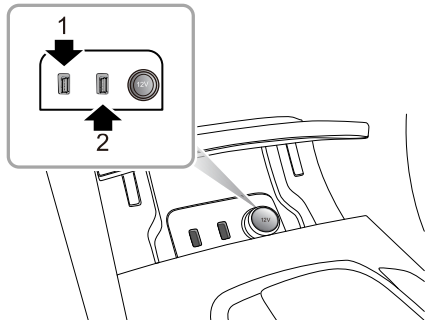

The 12V front power socket is located in the front of the centre console. When the START/STOP Switch is in the ACC/ON/READY position, remove the socket lid, it can then be used as a power supply.

There are two USB ports (1 and 2) located at the left side of 12V front power socket, the USB ports can provide 5V voltage serving as the power outlet, and can be used for data transmission.

There are also two USB ports located at the rear of the centre console, these provide 5V voltage serving as the power outlet.

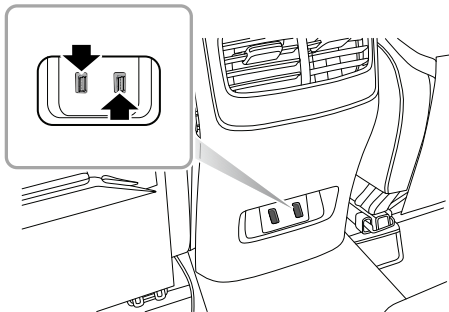

Note: Due to differences in configuration the charging function of the USB port will be slower.

INSTRUMENTS AND CONTROLS

Storage Devices

Instructions

- Please close all storage devices when the car is in motion. Leaving these storage devices open may cause personal injuries in cases of a sudden start-off, emergency braking and a car accident.
- Do not place flammable materials such as liquid or lighters in any storage devices. The temperature in hot conditions may ignite flammable materials and lead to a fire.

Glove Box

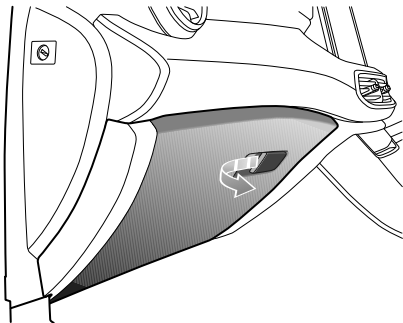

To open the glove box, pull the handle on the glove box cover (as indicated by the arrow). The glove box light will automatically illuminate.

Push the lid forward to close the glove box. Make sure the glove box is fully closed when the car is being driven.

Storage Box – Driver Side

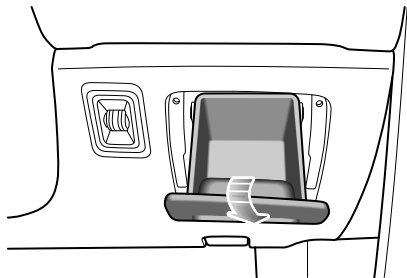

Located beneath the instrument panel on the driver side, pull the storage box lid down to open the box.

Centre Console Armrest Box

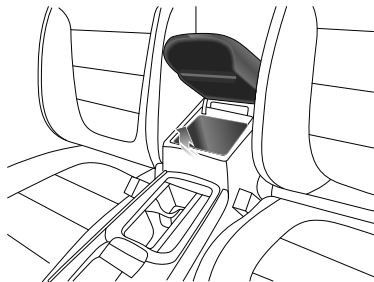

Lift the armrest (arrowed) to open the compartment cover. Put the cover down to close it.

INSTRUMENTS AND CONTROLS

Loadspace



DO NOT place articles on the rear parcel shelf, they could move causing personal injury in the event of an accident , emergency braking or hard acceleration.

Cup Holder



Do not place hot drinks in the cup holder whilst driving. Spillage may result in personal injury or damage.

Centre Console Cup Holder

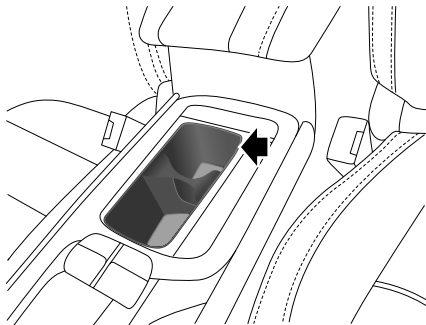

The centre console cup holder is situated at the front end of the centre console armrest assembly, it can be used to hold a cup or beverage bottle.

Rear Armrest and Rear Cup Holder

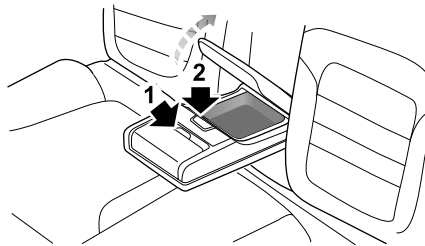

Fold forward to open the rear armrest. Press button 1 to open the cup holder. Press button 2 to open the storage box in the rear of the armrest.

INSTRUMENTS AND CONTROLS

Roof Luggage Rack *



Roof loads *MUST NOT* exceed the maximum authorised load. This may lead to injury or vehicle damage.



Loose or improperly fixed loads may fall from the roof luggage rack and lead to an accident or cause injury.



When heavy or large items are carried on the roof luggage rack it may lead to changes in steering, handling and braking characteristics. Please avoid sharp maneuvers, heavy braking and excessive acceleration.

Pay attention to the following when using the roof luggage rack:

- Fix loads towards the front of the roof as far as possible, and distribute the roof load evenly.
- DO NOT use automatic car washes with loads on the roof luggage rack.

- The overall height of the car is different when loads are fitted to the roof luggage rack. Please ensure there is adequate clearance when entering tunnels and garages.
- Ensure the loads carried by the roof luggage rack do not impede operation of the sunroof, roof antenna or tailgate opening.
- When installing or removing a piece of loading equipment, follow the instructions provided by the manufacturer of the loading equipment.

Maximum Authorised Load for the Roof

The maximum authorised load for the roof is 50 kg, and the roof load includes the weight of the roof loads and that of the loading equipment installed.

Be sure to know about the weight of loads, and weigh them when necessary. Never exceed the maximum authorised load for the roof.

Periodical Check

Always check the condition and security of bolt connectors and fasteners before using the roof luggage rack. Periodically check the condition and security of bolt connectors and fasteners.

Air Conditioning

88 *Ventilation*

91 *Automatic Temperature Control*

AIR CONDITIONING

Ventilation

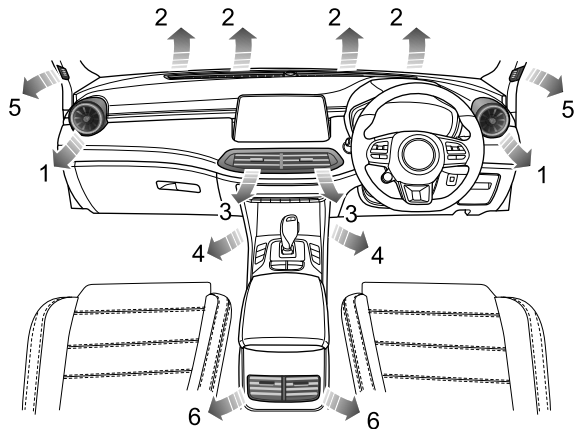

- 1 Side Vents
- 2 Windscreen/Defrost Vents
- 3 Centre Vent
- 4 Front Footwell Vents
- 5 Front Side Window Vents
- 6 Centre Console Vents

There are also 2 rear footwell vents, respectively on the floor under the front seats (not shown in the figure).

The heating, ventilation and air conditioning system provides fresh, cooling or heated air to the interior of the car. Fresh air is drawn in through the air intake grille under the front windscreen and the air conditioning filter.

Always keep the air intake grille clear of obstructions such as leaves, snow or ice.

A/C Particle/Pollen Filter

The particle/pollen filter helps to keep the car interior free from pollen and dust. To remain fully effective, the filter should be replaced at the recommended service interval.

Vents

Centre Vents

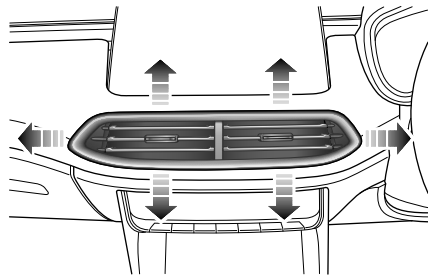

Slide the button in the centre of the louvres completely to the left or right to open or close the vent.

Toggle the button at the centre of each vent up and down, left and right to regulate the air direction.

AIR CONDITIONING

Side Vents

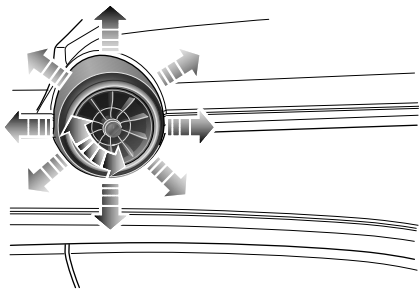

Rotate the centre thumb-wheel clockwise or anti-clockwise to open or close the vent. Toggle the centre thumb-wheel up, down, left or right to adjust the air direction.

Centre Console Vents

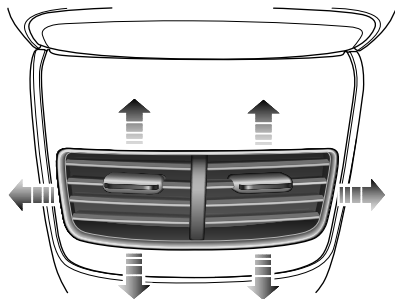

Slide the button in the centre of the louvres completely to the left or right to open or close the vent.

Toggle the button at the centre of each vent up and down, left and right to regulate the air direction.

Automatic Temperature Control

Infotainment Screen Control Interface

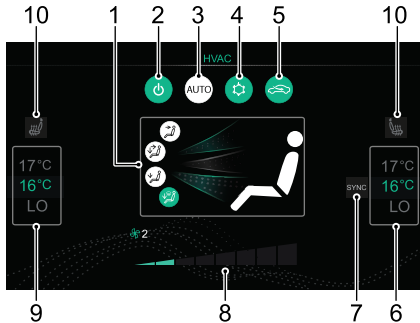

- 1 Air Distribution Mode
- 2 System On/Off
- 3 Auto Mode
- 4 AC Cooling On/Off
- 5 Air Circulation Mode
- 6 Right Zone Temperature Control
- 7 Temperature Zone Control
- 8 Blower Speed Control
- 9 Left Zone Temperature Control
- 10 Front Seat Heater *

AIR CONDITIONING

System On/Off

Touch the System On/Off Button on the control interface to switch the system on, all functions will revert to the state before shutdown. Touch again to switch off.

Note: *Turning off the infotainment screen will not affect the operation of the AC system*

AC Cooling On/Off

Touch the AC Cooling On/Off Touch Button to turn the AC cooling function ON/OFF.

Note:

- 1** *The cooling mode of the air conditioning will only operate when the vehicle is running or in READY mode.*
- 2** *The heating function is still available, when the AC cooling is switched off.*
- 3** *A small amount of water may remain in the air conditioner after usage, this may produce a peculiar smell. If this is a particular issue, it is recommended to switch off the cooling function*

and run the blower for a while with the engine running prior to switching off.

Air Circulation Mode

Touch the recirculation button on the control interface to operate the air recirculation function, the image displayed in the switch will change to display your chosen position (external or internal circulation), if the air intake is closed the air inside the car is recirculated, preventing the entry of traffic fumes.

Note: *Leaving the system in recirculation mode can cause the windscreen to mist. If this happens, switch off recirculation and turn the controls to maximum demisting.*

Auto Mode

Adjust the temperature on the infotainment screen control interface, set the target temperature required and then press the AUTO On/Off button to enable the auto control function.

In the auto mode, the air distribution mode and the blower speed are automatically adjusted to reach and maintain the required temperature.









Note: *To ensure the auto control operates efficiently, all windows and the sunroof must be closed and the A/C inlet grille must be clear of obstruction. In addition, the solar sensor on the upper part of the instrument panel should not be covered.*

Manual Mode

The air distribution mode and blower speed can be adjusted manually according to personal preference. In this case the AUTO indicator will extinguish.

Air Distribution Mode

Select the corresponding Air Distribution Mode Touch Button as required to regulate the air distribution mode.

Touch Button	Icons on Interface	Air Distribution Mode
		To 'face'
		To 'face' and 'feet'
		To 'feet'
		To 'feet' + 'windscreen'

To 'face'. Directs air to the side, centre and centre console vents.

To 'face' and 'feet'. Directs air to the footwell, side, centre and centre console vents.

To 'feet'. Directs air to the footwell vents.

Note: *In this mode, a small amount of airflow will be directed to the side, front side window and windscreen/defrost Vents.*

AIR CONDITIONING

To 'feet' + 'windscreen'. Directs air to the footwell, windscreen/defrost and front side window vents.

Note: *In this mode, a small amount of airflow will be directed to the side vents.*

Temperature Zone control

Touch the temperature zone control button to switch the system between single or dual temperature zone control. When the button is illuminated both zones are synchronised.

Blower Speed Control

Slide the blower speed segments left or right to regulate the blower speed, the lowest position is 1.

Touch the required blower speed segment to quickly set the required blower speed.

Temperature Control

Slide the temperature up or down to regulate the temperature of the air supplied by the vents.

Control Panel

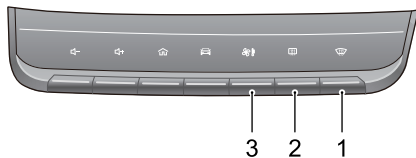

- 1 Defrost/Demist Button
- 2 Heated Rear Window Button
- 3 A/C Control Shortcut

A/C Control Shortcut



Short press the A/C control shortcut to display the air conditioning interface on the infotainment screen. Long press the A/C control shortcut to switch the system on/off.

During an Apple CarPlay or Android Auto telephone call, it is not possible to access the HVAC adjustment function

within the Infotainment System. This means that blower speed and temperature settings cannot be accessed or adjusted. Please hold the A/C Control Shortcut key in the Control Panel for 3 seconds, the blower will switch on or off depending on the current working state.

Note: *When switching the blower back on, the speed settings will revert to the settings prior to switching off.*

Defrost/Demist



Press Defrost/Demist Button on the control panel, the indicators in the button illuminate, the AC cooling and external circulation functions are switched on, and the system enters the most effective warm or cold air setting to clear the windshield and side window.

Pressing the Defrost/Demist Button again will exit the defrost/demist state, the indicator goes out, and the system will return to the previous state.

In the defrost/demist mode, operation of the AC cooling on/off button will switch the compressor on or off; operation of the air circulation mode button will switch

between internal circulation and external circulation, without affecting the defrost/demist mode in either case; operation of other air distribution modes will switch to a corresponding air distribution mode and quit the defrost/demist mode.

Note: *When the defrost/demist function is switched on below a preset temperature, the heated rear window function will automatically operate, the Defrost/Demist button and the heated rear window button indicator lights will illuminate simultaneously. To personalise this function please refer to 'Vehicle Settings' - HVAC*

Heated Rear Window



The heating elements on the inside of the rear window are easily damaged. DO NOT scrape or scratch the inside of the glass. DO NOT stick labels over the heating elements.



Press this button on the control panel to operate the heated rear window function, the indicator

AIR CONDITIONING

in the switch will illuminate. The heated rear window function will automatically turn off after operating for 15 minutes. If the switch is pressed again within 5 minutes, the heated rear window will operate and then remain on for a further 8 minutes. Pressing the switch whilst the heated rear window is on will switch off the function and extinguish the indicator in the switch.

Note: The heated rear window will only operate when the vehicle is running or in READY mode.

Note: Heated door mirrors only operate when the heated rear window is activated.

A/C Status

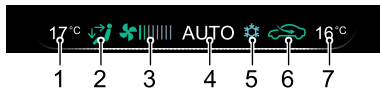

- 1 Left Zone Temperature Status
- 2 Air Distribution Mode Status :
 - For 'face'
 - For 'face' and 'feet'

- For 'feet'
 - For 'feet' and 'windscreen'
 - For 'windscreen'
 - Auto mode
- 3 Blower Speed Status
 - 4 Auto Mode Status
 - 5 AC Cooling Status
 - 6 Air Recirculation Mode Status :
 - Internal circulation
 - External circulation
 - 7 Right Zone Temperature Status

Seats & Restraints

98 *Seats*

103 *Seat Belts*

114 *Airbag Supplementary Restraint
System*

123 *Child Restraints*

SEATS & RESTRAINTS

Seats

Overview



To avoid personal injuries due to the loss of control, DO NOT adjust the seats while the car is moving.

An ideal position of the seat should make sure your driving position is comfortable, which allows you to hold the steering wheel with your arms and legs slightly bent and control all the equipment. Make sure your driving position is comfortable and enables you to maintain full control of the vehicle.

DO NOT recline the front seat backrest excessively. Optimum benefit is obtained from the seat belt with the backrest angle set to approximately 25° from the upright (vertical). The driver and front passenger seats should be positioned as far rearward as practical. Take care when adjusting the height of the front seat - the feet of the rear passenger could become trapped when the seat is lowered. A properly adjusted seat helps reduce the risk of injury from sitting too close to an inflating airbag.

Head Restraint



Adjust the height of the head restraint so that the top of it is in line with the top of the occupant's head. This location may reduce the risk of head and neck injuries in the event of a collision. DO NOT adjust or remove the head restraints while the car is moving.



DO NOT hang anything on any head restraint or head restraint rod.

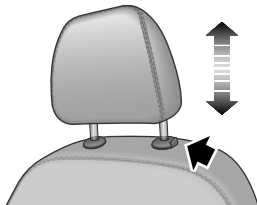

The head restraint is designed to prevent rearward movement of the head in the event of a collision or

emergency braking, thereby reducing the risk of head and neck injuries.

When adjusting a head restraint from low to high position, pull the head restraint directly upward, and gently press it downward after it reaches the desired position to make sure that it is locked in position. To remove the head restraint, press and hold the guide sleeve button (as indicated by the arrow) on the left of the head restraint, then pull the head restraint upward to remove it.

When adjusting a head restraint from high to low position, press the guide sleeve button (as indicated by the arrow) on the left of the head restraint, and press the head restraint downward; release the button after it reaches the desired position, and gently press the head restraint downward to make sure that it is locked in position.

Front Seats

Manual Seat *

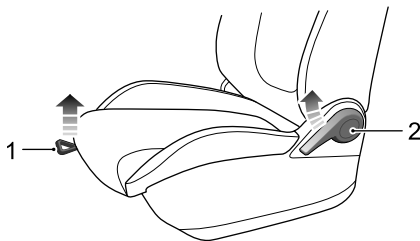

- Forward/Backward Adjustment

Lift the lever (1) under the seat cushion, slide the seat into an appropriate position and release the lever. Make sure that the seat is locked in place.

SEATS & RESTRAINTS

- Backrest Adjustment

Lift the lever (2), adjust the backrest until it moves into a satisfiable position , put down the lever.

Power Seat

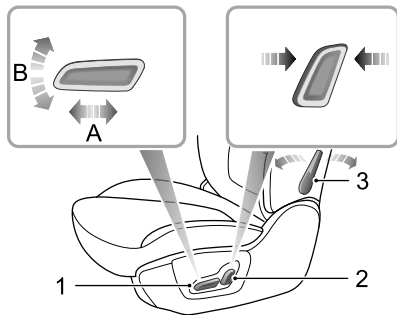

- Forward/Backward Adjustment

Push the switch (1) forward or backward (A) to move the seat forward/backward.

- Cushion Height Adjustment *

Pull the switch (1) upward or push downward (B) to raise or lower the seat cushion.

- Backrest Adjustment

Move the switch (2) forward/backward to adjust the backrest until it reaches the desired angle.

- Lumbar Support Adjustment *

Move the lever (3) to adjust the level of the lumbar support.

Rear Seats

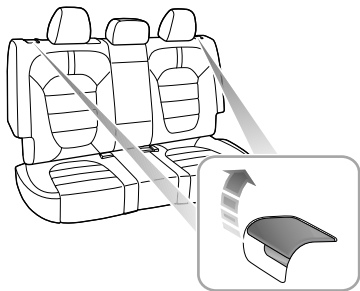

Adjustment of Rear Seat Backrest

Pull the control lever located at the top of the rear seat backrest upwards to release the locked state of the backrest; then adjust the backrest to the desired position, release the lever. Ensure the backrest is completely locked in position.

Folding Rear Seats

To increase the luggage space, the rear seat backrest can be folded fully forward. When folding the backrest completely, firstly insert the rear seat belt buckle into the corresponding slot, then fully lower (or remove) all head restraints, pull the respective control lever at the top of the seat backrest upwards and fold the seat backrest forward.

To return the backrest to an upright position, pull the respective control lever upward to release the lock, raise the backrest to the desired position, a click will be heard when the seat is locked.

Note: When returning the rear seat backrest to the desired position, make sure that the rear seat belt is not trapped.

Note: When the head restraint of the rear seat is not fully lowered or the backrest of the front seat is inclined backward excessively, the folding of the rear seat is very likely to damage the back of the front seat, small storage compartment or head restraint of the rear seat.

SEATS & RESTRAINTS

Note: *If the rear seat belt buckle is not completely inserted into the corresponding slot, folding the backrest is very likely to damage the rear seat backrest cover or foam.*

Front Seat Heating



If bare skin is in contact with the heated seats for excessive periods of time, it may cause burns.

The seat cushion and backrest of front seats are provided with heating elements. After the vehicle power mode is set to READY, access the air conditioning control interface and press the seat heating switch on the display to enable the heating function of the corresponding seat.



When pressing a seat heater switch, the corresponding seat will become warm. Press the switch again to stop the heating function. When the seat heating function is activated, the operating indicator in the switch illuminates. When the seat cushion and backrest

temperature reaches approximately 38°C, the heating function will be deactivated automatically.

IMPORTANT

- DO NOT cover the heated seats with blankets, cushions or other insulation type objects or materials.
- If the seat temperature has reached 38°C and continues getting hotter when using the seat heating system, please turn off the seat heating and contact an MG Authorised Repairer.
- Overuse of the driver's heated seat may cause drowsiness and could affect safety.

Seat Belts



It is important that all seat belts are worn correctly. Always check that all passengers are wearing seat belts. DO NOT carry passengers that are unable to wear correctly positioned seat belts. Wearing seat belts incorrectly may cause serious injury or even death in the event of a collision.



Airbags can not replace seat belts. Airbags can only provide extra support when triggered, and not all traffic accidents will trigger airbags. Whether airbags are triggered or not, seat belts can reduce the risks of serious injury or death in accidents. Therefore, seat belts must be worn correctly.



NEVER unfasten a seat belt whilst driving. Serious injury or death may occur in the case of an accident or emergency braking.



NEVER fasten the driver seat belt or use a buckle replacement when the driver seat is vacant or when exiting the vehicle. In some situations this could cause the engine to restart automatically.



This vehicle is equipped with seat belt warning lamp to remind you to fasten your seat belt.

During driving, seat belts must be fastened, this is because:

- You can never predict if you will be involved in a collision accident and how serious it may be.
- In many cases of collision accidents, passengers with seat belts correctly fastened are well-protected, while passengers with seat belts not fastened suffer from serious injury or even death.

Therefore, all passengers must wear seat belts correctly, even during short-distance journeys.

SEATS & RESTRAINTS

Protection Provided by Seat Belts



It is of equal importance for passengers in the rear seat to fasten their seat belts correctly. Otherwise, passengers with seat belts not correctly fastened will be thrown forward in accidents, and will endanger themselves as well as the driver and other passengers.

When the vehicle is in motion, the travelling speed of the occupants is identical to that of the vehicle.

In the event of a 'head on collision' or emergency braking, the vehicle may stop, but the occupants will carry on travelling until they come into contact with a stationary object. This object may be the steering wheel, dashboard, windscreen and others.

A correctly fastened seat belt will eliminate this risk of injury. When the seat belt is worn correctly, it will lock automatically in collision accidents or emergency braking to reduce your speed together with the vehicle, so as to prevent the out-of-control movement which may cause serious injury to driver and passengers.



Wearing Seat Belts



Incorrectly worn seat belts could cause injury or death in the event of an accident.



Seat belts are designed for one person. DO NOT share seat belts.



DO NOT wrap a seat belt around when holding a baby or child in your arms.



Remove any heavy coats or clothing when wearing a seat belt, failure to do so can affect protection provided by the seat belt.



Seat belts should not be wrapped around hard or sharp objects such as pens, spectacles or keys to avoid additional injury to the users.



Seat belts cannot function correctly when the seats are reclined excessively. DO NOT drive when the seats are excessively reclined.

The seat belts fitted to your vehicle are designed for use by normal sized adults. This part of the literature refers to adult use. For advice on seat belt use with children, please see 'Children and Seat Belts'.

All seat belts are 3 point lap-shoulder belts.

In order to maintain effective protection, the passengers must sit in the correct orientation, feet placed on the floor in front of them, with an upright body (no excessive recline) and the seat belt correctly fastened.

SEATS & RESTRAINTS

Fastening Seat Belts

Please follow the instructions below to fasten the seat belts correctly.

- 1 Adjust the seat correctly.
- 2 Hold the metal tab, pull the seat belt out steadily over the shoulder and across your chest. Ensure there is no twist on the belt.

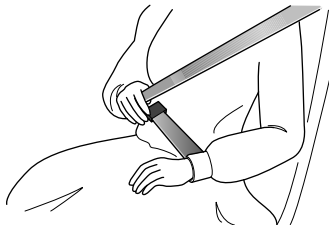

- 3 Insert the metal tab into the buckle until you hear a 'click', this indicates the seat belt is securely locked.

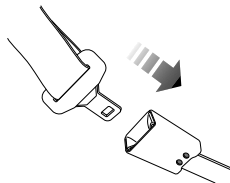

- 4 Remove any slackness in the belt by pulling up on the diagonal section of the belt.
- 5 To release the seat belt, press the red button on the buckle. The seat belt will retract automatically to its original place.

IMPORTANT

- Always ensure the seat belt will not become trapped in the door aperture when closing the door, damage will occur.
- Pulling the seat belt out too quickly may cause it to 'lock'. In this case, allow the seat belt to retract slightly and then pull it across your body slowly.
- If it is difficult to pull the seat belt out, it may be due to twisted webbing. If this is the case, fully extract the seat belt, remove the twist, allow the seat belt to retract slowly.
- When using the rear seat belts please ensure they are fully retracted into the correct position to avoid jamming in the rear seat catches. Even if the seat belt is not completely smoothed, it is still required to be worn during driving, but the twisted part of the seat belt shall not contact the passenger. When this happens, please go to an MG Authorised Repairer for repair.

Correct Routing of the Seat Belts



Ensure the seat belt is correctly positioned on the body, NEVER cross the neck or abdomen, NEVER pass the seat belt behind the back or under the arms.

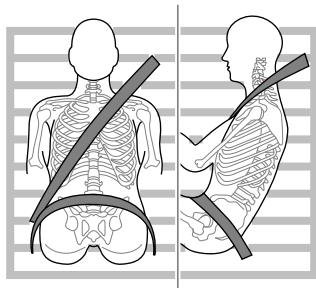

When wearing seat belts, the lap belt section should be positioned as low as possible across your hips. NEVER cross the abdomen. In the event of a collision, the lap belt can apply a force on the hips and reduce the possibility of

SEATS & RESTRAINTS

you slipping under the lap belt. If you slip under the lap belt, the belt will apply force on your abdomen, which may cause serious or fatal injuries. The diagonal section of the belt should cross the middle of the shoulder and the chest. In the event of emergency braking or collision, the diagonal section of the belt will be locked. NEVER position a seat belt across your neck, across the body under your arms or behind your back.

To ensure that the seat belts always provide maximum protection, ensure the belt is flat, not loose and contacts the body.

Upper Anchorage Height Adjustment



During driving, DO NOT adjust the height of seat belt.



Ensure the fixing point of seat belt is adjusted to the proper height and locked before driving, otherwise injury or even death may occur in collision accidents.

The vehicle is equipped with an adjustable upper fixing point on the driver and passenger seat belts. Adjust the height so that the diagonal section of the belt crosses the middle of the shoulder. The seat belt should be positioned away from the neck and head and in a manner where the occupant cannot slide under the belt. incorrect positioning will reduce the efficiency of the seat belt in the event of a collision or emergency braking.



Adjusting the seat belt fixing point correctly.

- I Hold the seat belt.

- 2 Press release button and move the height adjuster to desired position. Move the adjuster by pushing the slider.
- 3 After moving the adjuster to desired position, release the button and try to move the adjuster downward to determine whether it is locked in place. The adjuster must be locked in place prior to use.

Seat Belts During Pregnancy

Wearing correctly positioned seat belts will provide protection for both mother and unborn child in the event of a collision or emergency braking.



The diagonal section of the seat belt should pass across the chest as normal, the lap section of the belt should pass below the belly, low and snug on the hip bones. NEVER position the belt on or above the belly.

Please consult your physician for further details.

Seat Belts and Disabilities

It is a legal requirement that all occupants wear seat belts, this include people with disabilities.

Depending upon the disability, consult your physician for further details.

SEATS & RESTRAINTS

Children and Seat Belts

! *Proper protection measures must be taken for children during driving.*

For safety reasons, children shall ride in child restraint device fixed to the rear seat.

Infants

! *Only recommended child restraints suitable for the age, height and weight of the child should be used.*

! *NEVER carry a child or infant with your arms during driving. When collision accidents occur, the weight of child will produce so great force that you can not hold the child. The child will be thrown forward and suffer serious injury or even death.*

The seat belts fitted to your vehicle are designed for adults, they are not suitable for children. In the event of an accident or collision the children are not secure, it could cause death or serious injury.

Infants **MUST** use a suitable child restraint device. Please consult the child seat manufacturers guide lines when selecting the correct seat. Follow the manufacturers instructions on installation. Please refer to "Child Restraints" in this chapter for more details.

Older Children

! *NEVER share a seat belt amongst children. In the event of an accident or collision the children are not secure, it could cause death or serious injury.*

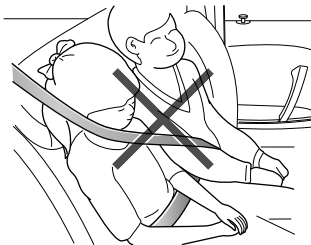

As children grow and become older/larger it will get to the stage when they no longer require child seat restraints, at this point they will require use of the vehicle standard seat belt. Please ensure the seat belt is correctly positioned on the body of the child.

When fastening a seat belt for a child always check it for correct positioning. Adjust the height of seat belt to ensure the shoulder belt is kept away from the child's face and neck. Position the lap belt across the hips as low as possible, and tighten adequately. Correct positioning means that the seat belts can pass the applied force to the strongest part of child's body in accidents.

If the shoulder belt is too close to child's face or neck, it may be necessary to use a child booster cushion (always ensure that it meets any relevant laws or standards.

Seat Belt Pre-tensioners



*The seat belt pre-tensioners will only be activated once and then **MUST BE REPLACED**. Failure to replace the pre-tensioners will reduce the efficiency of the vehicle's restraint system.*



If the pre-tensioners have been activated, the seat belts will still function as restraints, and must be worn in the event that the vehicle remains in a drivable condition. The seat belt pre-tensioners should be replaced at the earliest opportunity by an MG Authorised Repairer.

The vehicle is fitted with seat belt pre-tensioners, these are designed to retract the seat belts and work in conjunction with the airbags in the event of a severe collision. They are designed to retract the seat belt and 'secure' the occupant in the seat.

The airbag warning light on the instrument pack will alert the driver to any malfunction of the seat belt

SEATS & RESTRAINTS

pretensioners.(see 'Warning Lamps and Indicators' in the 'Instruments and Controls' chapter).

The seat belt pre-tensioners can only be activated once, after activation they must be replaced. This may also involve replacement of other SRS components. Please refer to 'Replacing Airbag System Parts'.

IMPORTANT

- Seat belt pre-tensioners will not be activated by minor impacts.
- The removal or replacement of a pre-tensioner must be carried out by the manufacturer trained, dealer technicians.
- 10 years from the initial date of registration (or installation date of a replacement seat belt pre-tensioner), some components will need to be replaced. The appropriate page of the Service Records must be signed and stamped once the work has been completed.

Seat Belt Checks, Maintenance and Replacement

Seat Belt Checks



Split, worn or frayed seat belts may not function correctly in the event of a collision, if there are any signs of damage, replace the belt immediately.



Always ensure the red release button on the seat belt buckle is pointing upwards to ensure easy release in the event of an emergency.

Please follow the instructions below to check the seat belt warning lamp, seat belt, metal tab, buckle, retractor and fixing device regularly:

- Insert the seat belt metal tab into the corresponding buckle and pull seat belt webbing close to the buckle quickly to check that the belt clasp locks.
- Hold the metal tab and pull the seat belt forward quickly to check that the seat belt reel locks automatically, preventing the webbing from extending.

- Fully extract the seat belt and visibly examine for twists, fraying, splits or worn areas.
- Fully extract the seat belt and allow to return slowly to ensure continual and complete smooth operation.
- Visibly examine the seat belt for missing or broken components.
- Ensure the seat belt warning system is fully functional.

If the seat belt fails any of the above tests or inspections contact an MG Authorised Repairer immediately for repairs.

Seat Belt Maintenance



DO NOT attempt to remove, install, modify, disassemble or dispose of the seat belts. Have any necessary repairs carried out by your MG Authorised Repairer. Inappropriate handling may lead to incorrect operation.



Ensure no foreign or sharp objects become lodged in the seat belt mechanisms. DO NOT allow liquids to contaminate the seat belt buckle, this could affect the buckle engagement.

Seat belts should only be cleaned with warm soapy water. DO NOT use any solvent to clean the seat belt. DO NOT attempt to bleach or dye the seat belt, it may weaken the seat belt. After cleaning, wipe with a cloth and allow to dry. DO NOT allow the seat belt to fully retract before it is completely dry. Keep seat belts clean and dry.

If there are contaminants accumulated in the retractor, the retraction of the seat belt will be slow. Please use a clean and dry cloth to remove any contaminants.

Replacing Seat Belts



Collision accidents may damage the seat belt system. The seat belt system may not be able to protect users after damage which may result in serious injury or even death. After an accident, seat belts should be checked and replaced as needed immediately.

Seat belts should not require change after minor collisions, however, some other parts of the seat belt system may require attention. Please consult an MG Authorised Repairer for advice.

SEATS & RESTRAINTS

Airbag Supplementary Restraint System

Overview



The airbag SRS provides ADDITIONAL protection in a severe frontal impact only. It does not replace the need, or requirement to wear a seat belt.



The airbags together with the seat belts provide optimum protection for adults, but it is not the case for infants. The seat belt and airbag systems in the vehicle are not designed for protecting infants. The protection required by infants should be provided by child restraints.

The Airbag Supplementary Restraint System generally consists of:

- Front Airbags (fitted to the centre of the steering wheel and dashboard above the glove compartment)

- Seat Side Airbags (fitted to the outer side of the seat squab)
- Side Head Impact Protection Airbags (fitted behind the headlining)

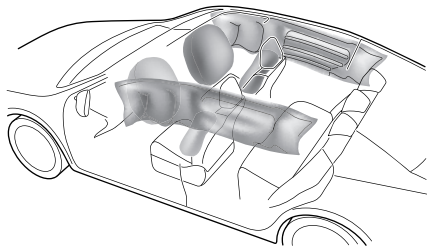

In the corresponding place where airbags are fitted, there is a warning sign stating 'AIRBAG'.

Airbag Warning Light



The airbag warning light is located in the instrument pack. If this lamp does not extinguish or illuminates during driving, it indicates that there is a failure in the SRS or seat belt. Please consult an MG Authorised Repairer at the earliest opportunity. An SRS or seat belt fault may mean the components may not be deployed in the event of an accident.

Airbag Deployment



Front seat passengers should not place feet, knees or any other part of the body in contact with, or in close proximity to a front airbag.



To minimise the risk of accidental injury from inflating airbags, seat belts should be worn correctly at all times. In addition, both driver and front seat passenger should adjust their seat to provide sufficient distance from the front airbags. If side airbags/side head impact protection airbags are fitted, both driver and front seat passenger should be seated to maintain sufficient distance from the upper part of the body to the sides of the vehicle, this will ensure maximum protection when the side airbags/side head impact protection airbags are deployed.

SEATS & RESTRAINTS



When airbags are deployed, children without proper protection may suffer from serious injury or even death. DO NOT carry children in the arms or on the knees during traveling. Children should wear seat belts suitable to age. DO NOT lean out of windows.



An inflating airbag can cause facial abrasions and other injuries if the occupant is too close to the airbag at the time of its deployment.



DO NOT affix or place any objects on, or adjacent to the airbags. This may affect the airbag passage or create projectiles that may cause injury or serious harm in the event of airbag deployment.



After deployment the airbag components become very hot. DO NOT touch any airbag related components, it may cause burns or serious injury.



DO NOT knock or strike the position where airbags or related parts are located, so as to avoid accidental airbag deployment which may cause serious injury or even death.

In the event of a collision, the airbag control unit monitors the rate of deceleration or acceleration induced by the collision, to determine whether the airbags should be deployed. Airbag deployment is virtually instantaneous and occurs with considerable force, accompanied by a loud noise.

Provided the front seat occupants are correctly seated and with seat belts properly worn, the airbags will provide additional protection to the chest and facial areas in the event of the car receiving a severe frontal impact.

Side airbags and side head impact protection airbags are designed to offer additional protection to the side of the body facing the impact, if a severe side collision occurs.

IMPORTANT

- Airbags can not protect lower body parts of passengers.
- Airbags are not designed for rear collision, minor frontal or side impacts, or if the vehicle overturns; nor will it operate as a result of heavy braking.
- Deployment and retraction of the frontal and side airbags takes place very quickly and will not protect against the effects of secondary impacts that may occur.
- When an airbag inflates, a fine powder is released. This is not an indication of a malfunction, however, the powder may cause irritation to the skin and should be thoroughly flushed from the eyes and any cuts or abrasions of the skin.
- After inflation, front and side airbags deflate immediately. This provides a gradual cushioning effect for the occupant and also ensures that the driver's forward vision is not obscured.

Front Airbags



NEVER use a rearward facing child restraint on a seat protected by an ACTIVE AIRBAG in front of it, DEATH or SERIOUS INJURY to the CHILD can occur. Refer to 'Disabling the Passenger Airbag'.



Front seat passengers should not place feet, knees or any other part of the body in contact with, or in close proximity to a front airbag.



In extreme cases driving on very uneven surfaces may cause airbag deployment. Please take extra care when driving on uneven roads.

Airbags are designed to deploy during serious impacts, the following conditions may cause airbag deployment.

- A frontal collision with unmovable or non deformable solid objects at a high speed.
- Conditions that can cause serious chassis damage, such as a collision with kerbstones, road edges, deep ravines or holes.

SEATS & RESTRAINTS

Seat Side Airbags



The manufacture and material of the seat is critical to the correct operation of side airbags. Therefore, please DO NOT fit seat covers which may affect side airbag deployment.

In the event of a serious side impact, the relevant side airbag will deploy (only the affected side).

- The airbag will be deployed in the event that the side of the vehicle is impacted with a solid object or another vehicle.

Side Head Impact Protection Airbags

In the event of a serious side impact, the relevant side curtain airbag will deploy (only the affected side).

- The side curtain airbag will be deployed in the event that the side of the vehicle is impacted with a solid object or another vehicle.

Conditions in Which Airbags Will Not Deploy

The deployment of airbags does not depend on the vehicle speed, but on the object that the vehicle hits, angle of impact and the rate at which the car changes speed as a result of a collision. When the impact force of collision is absorbed or dispersed to vehicle body, airbags may not deploy; however, airbags may sometimes deploy according to impact condition. Therefore, the deployment of airbags shall not be judged based on the severity of vehicle damage.

Front Airbags

Under certain conditions the front airbags may not be deployed. Some examples are listed below:

- The impact point is not central to the front of the vehicle.
- The impact is not of sufficient force (the impact is with an object that is not solid, such as a lamp post or central barriers).
- The impact area is high (collision with the tailgate of a truck).
- Impacts to the rear or side of the vehicle.

- The vehicle rolling over.
- Frontal collision at an angle with guard bars.

Seat Side Airbags and Side Head Impact Protection Airbags

Under certain conditions the seat side and side head airbags may not be deployed. Some examples are listed below:

- Side impacts at certain angles.
- Light side impacts such as a motorcycle.
- Impacts that are not central to the side of the vehicle, either too far toward the engine compartment or the loadspace.
- The vehicle rolling over.
- Frontal collision at an angle with guard bars.
- The angled impact is not of sufficient force (the impact is with an object that is not solid, such as a lamp post or central barriers).
- The impact is not of sufficient force (with another vehicle, stationary or moving).
- The impact is from the rear of the vehicle.

Disabling the Passenger Airbag

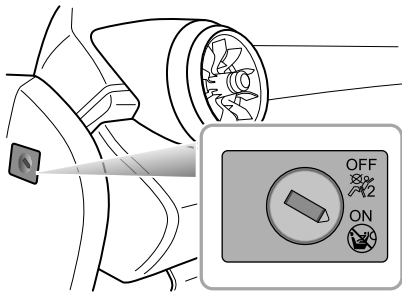

The passenger airbag switch is located in the left fascia panel end cover trim. Insert the key and rotate the switch to the on or off position to enable or disable the passenger airbag.

Note: *The Passenger Airbag should only be disabled when a rear facing child seat is fitted to the front passenger seat.*

SEATS & RESTRAINTS

Note: *When an adult is seated in the front passenger seat, ensure that the airbag is switched on.*

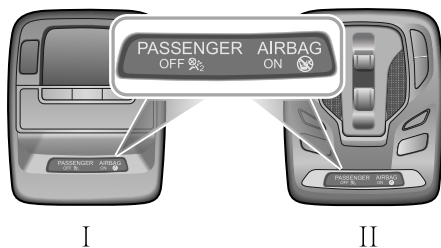

The passenger airbag status light is located in the roof mounted interior lamp assembly. The shape of the lamp assembly varies according to the configuration of the vehicle.

When the switch is turned to the OFF position, the OFF indicator light (located in the PAB display panel in the lamp

assembly) illuminates, this indicates that the passenger airbag is disabled.

When the switch is turned to the ON position, the ON indicator light (located in the PAB display panel in the lamp assembly) illuminates, this indicates that the passenger airbag is enabled.

Service and Replacement of Airbags

Service Information



DO NOT install or modify the airbag. Any changes to the vehicle structure or airbag system wiring harness are strictly prohibited.



Changes to vehicle structure is prohibited. This may affect the normal operation of the SRS.



DO NOT allow these areas to be flooded with liquid and DO NOT use petrol, detergent, furniture cream or polishes.



If water contaminates or enters the SRS it may cause damage and affect deployment. In this case contact an MG Authorised Repairer immediately.

To prevent damage to the airbag SRS, the following areas should be cleaned sparingly with a damp cloth and upholstery cleaner ONLY:

- Steering wheel centre pad.
- Area of dashboard containing the passenger airbag.
- Area of roof lining and front pillar finishers which enclose the side head impact protection modules.

If the airbag warning lamp fails to illuminate, stays on, or if there is damage to the front or side of the vehicle, or the airbag covers show signs of damage, contact an MG Authorised Repairer immediately.

IMPORTANT

- The removal or replacement of an airbag module should be carried out by an MG Authorised Repairer.
- After 10 years from the initial date of registration (or installation date of a replacement airbag), some components will need to be replaced by an MG Authorised Repairer. The appropriate page of the Service Records must be signed and stamped once the work has been completed.

SEATS & RESTRAINTS

Replacing Airbag System Parts



Even if the airbag does not deploy, collisions may cause damage to SRS in the vehicle. Airbags may not function properly after damage, and can not protect you and other passengers when a second collision occurs, which may cause serious injury or even death. To ensure that SRS can function properly after collision, please go to an MG Authorised Repairer to check airbags and repair as necessary.

Airbags are designed for using once only. Once the airbag is deployed, you must replace SRS parts. Please go to an MG Authorised Repairer for replacement.

Disposal of Airbags

When your vehicle is sold, ensure that the new owner knows the vehicle is equipped with airbags, and is aware of the replacement date of SRS.

If the vehicle is scrapped, the undeployed airbags may have potential risks, therefore, before the disposal, they must be

deployed safely in a certain environment by a professional from an MG Authorised Repairer.

Child Restraints

Important Safety Instructions about Using Child Restraints

It is recommended that children below the age of 12 years old should be seated on the rear seat of the vehicle, in a child restraint system appropriate to the children's weight and size. Infants less than 2 years old should be restrained in an infant child restraint system.

It is recommended that a child restraint system that complies with UN ECE-R44 or ECE-R129 standard are fitted in this vehicle. Check markings on the child restraint system.

There are a number of child restraint systems available of different type and specification. For optimum protection, it is recommended that you choose restraint systems appropriate to the child's age and weight.

It is important to comply with installation instructions supplied by the child restraint manufacturer and that child restraint system is properly secured to the vehicle. Failure to follow these instructions may cause death or serious injury to the child in an event of a sudden stop or accident.

- All occupants, including children must wear seat belts or use an appropriate child restraint.
- MG strongly recommends that children under 12 years of age or less than 1.5 metres tall should use the appropriate child restraint fitted to the rear seat.
- Only one child can be carried in any one restraint.
- Do not put the child on the lap or in arms when sitting in any seat.
- Always adjust the seat back rest to a proper position and ensure it is locked in position when installing a child seat or restraint.
- If installing a rear facing child restraint to the rear seat, the corresponding front seat should be adjusted forward; if installing a forward facing child restraint to the rear seat, you may need to adjust the height of the headrest to the lowest; if installing a forward facing child restraint to the front seat, you may need to remove its headrest.
- Never let your child stand or kneel on the seat during driving.
- Always ensure the child is seated correctly in the child restraint.

SEATS & RESTRAINTS

- The ways of using seat belts have a great influence on the maximum protection offered by the seat belt, you must comply with the child restraint manufacturer's instructions on proper use of seat belts. If seat belts are not properly fastened, a minor traffic accident may also lead to injury.
- Child restraints that are not fitted correctly may move and injure other occupants in the event of an accident or emergency braking. Therefore, even if there is no infant or child in the child restraint, it also should be fitted properly and securely in the vehicle.

Warnings and Instructions on Use of Child Restraint on Front Passenger Seat



NEVER use a rearward facing child restraint on a seat protected by an ACTIVE AIRBAG in front of it, DEATH or SERIOUS INJURY to the CHILD can occur.



In cases where there is a need to install a rear facing child restraint on the front passenger seat, use the key to deactivate the front passenger airbag function, or severe injury or even death can occur.



Once the child restraint is removed from the front passenger seat, use the key to reactivate the front passenger airbag.



When installing a child restraint on the front passenger seat, move the front passenger seat as far rearward as possible.



Use one child restraint per child.

Please study the safety warning label on the sun visor. Where possible always install child restraints on the rear seat. If it is necessary to install a child restraint on the front seat please observe the warnings above.

Children's Safety and Side Airbags



Children should not be allowed in areas where airbags may be deployed, there is a risk of serious injury.



Only recommended child restraints suitable for the age, height and weight of the child should be used.



DO NOT place any items in areas where airbags may be deployed, there is a risk of serious injury.

In the event of a side collision, the side airbags can provide better protection for the passenger. However, when the airbag is triggered a very strong expansion force is generated, if the passenger's seating position is not correct,

the airbags or items in the side airbag deployment area may cause injury.

When the correct child restraint is used to secure the child properly in the rear seat and the child's seating position is correct, there is enough space between the child and the side airbag deployment region for the airbag to deploy without any hindrance, and thus provide the best protection.

SEATS & RESTRAINTS

Child Restraints Groups

Secured Using 3 Point lap Diagonal Belts



Please **DO NOT** put the rear facing child restraint in the front passenger seat, this may cause serious injury or even death.

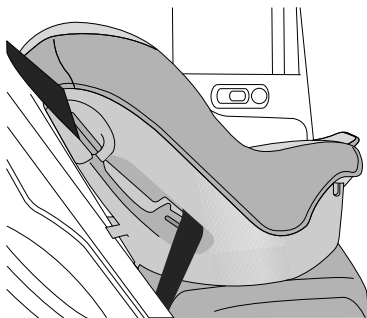

It is recommended that children should always be seated in the rear of the vehicle in a child restraint or restraint system, and fixed with 3 point, lap diagonal seat belts.

ISOFIX Child Restraint Systems



The ISOFIX anchorages in the rear seat are designed for use with ISOFIX systems only.



Child restraint anchorages are designed to withstand only those loads imposed by correctly fitted child restraints. Under no circumstances are they to be used for adult seat belts, harnesses, or for attaching other items or equipment to the vehicle.

Note: When installing and using any child restraint system, always follow the manufacturer's instructions.

Note: The rear seats fitted to this vehicle are provided with the ISOFIX interface (as indicated by the arrow in the following image), these are designed to connect to an ISOFIX child seat.

- 1 Fasten vehicle-approved ISOFIX child restraint systems to the mounting brackets.
- 2 When using ISOFIX mounting brackets for seat mounting, universally approved child restraint systems for ISOFIX may be used.

SEATS & RESTRAINTS

Note: When using seat mounting, universally approved child restraint systems, top tether must be used.

Note: Please refer to the child restraint system manufacturer's instructions for details.

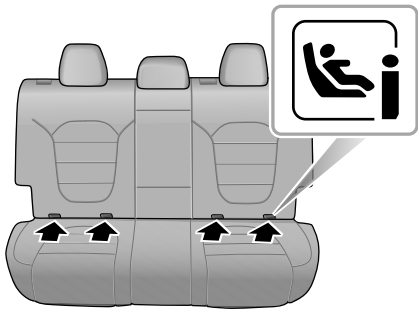

- 3 To fasten the top tether strap of the child restraint system, route the tether strap under the head restraint and attach to the anchorage hook being careful not to

twist the strap. If not using ISOFIX lower anchorages, using the seatbelt, complete the installation in line with the child restraint manufacturers instructions.

- 4 After installation apply suitable force to ensure the restraint is securely fastened.

Note: When installing and removing any child restraint system, always follow the manufacturer's instructions.

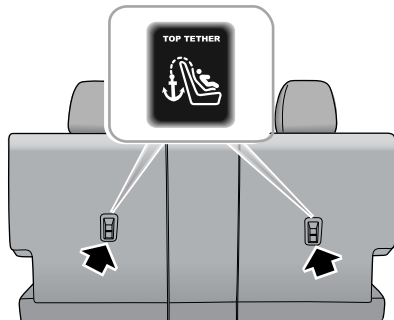

SEATS & RESTRAINTS

Approved Child Restraint Positions

It is recommended that a child restraint system that complies with UN ECE-R44 or ECE-R129 standard are fitted in this vehicle. Check markings on the child restraint system.

Approved Child Restraint Positions (for non ISOFIX Child Restraints)

Mass Group	Seating Positions			
	Front Passenger		Rear Outboard	Rear Middle
	With Front Passenger Airbag OFF Switch			
	Airbag ON	Airbag OFF		
0 group (less than 10 kg)	X	U	U	U
0+ group (less than 13 kg)	X	U	U	U
I group (9 ~ 18 kg)	X	U	U	U
II group (15 ~ 25 kg)	X	U	U	U
III group (22 ~ 36 kg)	X	U	U	U

Note: Description of letters in the table:

U = Suitable for universal child restraint systems approved for this mass group;

X = Seat position not suitable for child restraint systems in this mass group.

Approved Child Restraint Positions (for ISOFIX Child Restraints)

Seating Position		Mass group categories			
		0 group	0+ group	I group	
		Rear facing		Forward facing	Rear facing
		Up to 29 lbs(13 kg)		20–40 lbs(9 ~ 18 kg)	
Front Passenger Seat	Size Class	Not ISOFIX equipped			
	Seat Type				
Rear Outboard Seat ISOFIX	Size Class	C,D,E ¹	A,B, BI ¹	C,D ¹	
	Seat Type	IL ²	IL ² ,IUF ³	IL ²	
Rear Centre Seat	Size Class	Not ISOFIX equipped			
	Seat Type				

Note: IL Suitable for particular ISOFIX child restraints systems of the semi-universal category. Please consult child restraints systems suppliers' vehicle recommendation lists;

IUF Suitable for ISOFIX forward facing child restraints systems of universal category approved for use in this mass group and ISOFIX size class;

¹. The ISOFIX size class for both universal and semi-universal child seat systems is defined by the capital letters grade A ~ G. These identification letters are displayed on the ISOFIX child seat;

SEATS & RESTRAINTS

2. At time of publishing the recommended Group 0+ ISOFIX baby safety seat is the Britax Romer Baby Safe;
3. At time of publishing the recommended Group I ISOFIX child seat is the Britax Romer Duo.

Note: At time of publishing the recommended Group II-III ISOFIX child seat is the KidFix II XP SICT and KidFix² R.

Table of I- Size child seats

The table gives a recommendation for which I- Size child seats suit which locations, and for what size of child.

The child seat must be approved in accordance with UN Reg R129.

Type of child seat	Front passenger seat	Rear outboard seats	Rear centre seat
I- Size child restraint systems	X	I-U	X

Note: I-U Suitable for use with forward and rear facing I- Size child restraint systems.

X Not suitable for use with I- Size restraint systems.

Group 0/0+ Child Restraint



When the front passenger airbag is active, never place a rear facing child restraint on the front passenger seat, severe injury or even death can occur.

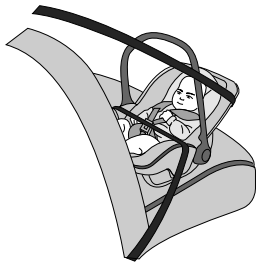

Child restraints that can be adjusted to lying position are most suitable for infants who are lighter than 10 kg (normally for those younger than 9 months) or those who are lighter than 13 kg (normally for those younger than 24 months).

Group I Child Restraint



When the front passenger airbag is active, never place a rear facing child restraint on the front passenger seat, severe injury or even death can occur.



Backward/forward child restraints are most suitable for infants whose weight is 9 ~ 18 kg (normally for those older than 9 months and younger than 4 years old).

SEATS & RESTRAINTS

Group II Child Restraint



The diagonal section of the seat belt should pass across the shoulder and upper body, away from the neck. The lap section of the belt should pass across the hips, away from the abdomen.



The combination of child restraint and 3 point lap diagonal seat belt is most suitable for children whose weight is 15 ~ 25 kg (normally for those older than 3 years old and younger than 7 years old).

Group III Child Restraint



The diagonal section of the seat belt should pass across the shoulder and upper body, away from the neck. The lap section of the belt should pass across the hips, away from the abdomen.



The combination of child booster seat and vehicle 3 point lap diagonal seat belt is most suitable for children whose weight is 22 ~ 36 kg and whose height is below 1.5 m (normally for those about 7 years old or those older than 7 years old).

Starting & Driving

- 134 Keys
- 137 Child Proof Locks
- 138 Alarm Systems
- 148 Starting and Stopping Power System
- 153 Pedestrian Alert Control System
- 154 Economical and Environmental Driving
- 157 Catalytic Converter and Particulate Filter
- 159 Fuel System
- 163 Vehicle Hybrid Control
- 164 Charging Requirements
- 173 Electric Drive Transmission (10-Speed)
- 181 Brake System
- 194 Stability Control System (SCS) and Traction Control System (TCS)
- 196 Tyre Pressure Monitoring System (TPMS)
- 197 Adaptive Cruise Control System
- 207 Parking Aid System
- 211 Rear Driver Assistance System
- 218 Driving Assist System
- 248 Load Carrying

STARTING & DRIVING

Keys

Overview



Please keep the spare key in a safe place - not in the car!



It is recommended that spare keys are not kept on the same key ring, since this may cause interference, prevent correct key recognition and therefore prevent the correct operation of the vehicle power system.



The smart key contains delicate circuits and must be protected from impact and water damage, high temperature and humidity, direct sunlight and the effects of solvents, waxes and abrasive cleaners.

Your vehicle is supplied with two smart keys, each one contains a back up mechanical key blade, this will operate the driver door mechanical lock. The smart keys supplied are programmed to the security system on the car, any key that is not programmed to the car will not operate the keyless entry function or the vehicle immobiliser.

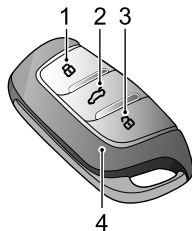

- 1 Lock Button
- 2 Tailgate Button
- 3 Unlock Button
- 4 Smart Key

The smart key only works within a certain range. Its working range is sometimes influenced by the key battery condition, physical and geographical factors. For safety consideration, after you lock your vehicle using the smart key, please recheck to ensure the vehicle is locked.

If your key is lost/stolen or broken, a replacement can be obtained from an MG Authorised Repairer. The lost/stolen

key can be deactivated. If the lost key is found, an MG Authorised Repairer can reactivate it.

Note: Any key made independently outside of MG Authorised Repairer Network may not allow your car to enter READY mode, and may affect the safety of your car. To obtain a suitable key replacement, it is recommended that you contact an MG Authorised Repairer.

Note: The new key cannot be offered to you immediately because it requires programming to the vehicle by the MG Authorised Repairer.

Note: When operating your vehicle with the smart key, avoid placing it near any devices with strong radio interference (such as notebook computers and other electronic products), the normal function of the key may be affected.

Replacing the Battery

Please use the picture guide to replace the smart key battery if any of the following conditions occur:

- The smart key locking/unlocking function range is reduced;
- The immobilisation warning lamp on the instrument pack flashes.

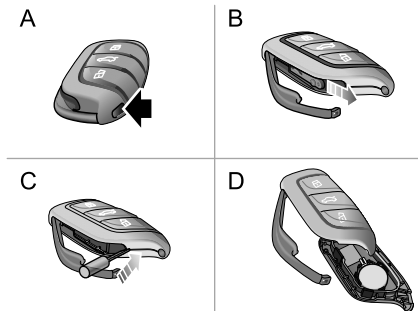

STARTING & DRIVING

- 1 Press the button (A) on the smart key to eject the decorative trim.
- 2 Remove the backup mechanical key (B) in the arrowed direction.
- 3 Using a suitable flat bladed tool, insert the tool into the side of the key (C), carefully prise off the battery cover and separate the upper and lower casings (D).
- 4 Remove the battery from the slot.
- 5 Put the new battery in the slot, and make sure it is in full contact with the slot.

Note: *Make sure that the polarity of battery is correct ('+' side facing down).*

Note: *It is recommended to use a CR2032 battery.*

- 6 Refit the cover and press tightly, ensuring the gap around the cover is even.
- 7 Refit the mechanical key, and close the decorative trim.
- 8 Set the vehicle power system to READY to resynchronise the key with the vehicle.

IMPORTANT

- Use of an incorrect or inappropriate battery may damage the smart key. The new replacement's rated voltage, sizes and specifications must be the same as the old one.
- Incorrect fitting of the battery may damage the key.
- Disposal of the used battery must be strictly in accordance with relevant environmental protection acts.

Child Proof Locks



NEVER leave children unsupervised in the car.

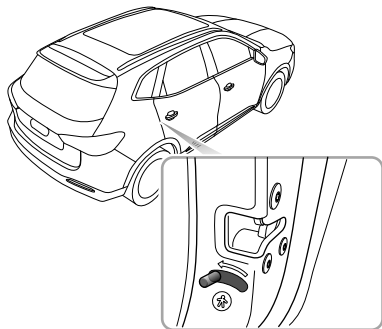

- Move the lever to the unlock position in the reverse direction of the arrow to disable the child proof lock. With the child proof locks engaged, the rear doors cannot be opened from inside the car, but can be opened from outside the car.

Steps for enabling or disabling the child proof locks are as follows:

- Open the rear door at corresponding side, move the child proof lock lever to the lock position in the direction of the arrow to engage the child proof lock;

STARTING & DRIVING

Alarm Systems

Your car is fitted with an body anti-theft system and power immobilisation system. To ensure maximum safety and operation convenience, we strongly recommend you to carefully read this chapter to fully understand the activation and deactivation of anti-theft systems.

Power Immobilisation

Power Immobilisation is designed to safeguard the vehicle from theft. The power immobilisation system can only be deactivated to start the car by using the matched key.

Press the START/STOP Switch, once a valid key is detected in the vehicle, immobilisation system will be deactivated automatically.

If the message centre displays "Smart Key Not Detected" or "Put Key Into Back-up Position" or the power immobiliser system warning lamp illuminates, please put the smart key into back-up position (refer to "Alternative Starting Procedure" in "Starting and Stopping the Power System" section), or try to use the spare key. If the car can still not be started, please contact an MG Authorised Repairer.

Body Anti-theft System

Locking and Unlocking

When the vehicle is locked, the indicator lamps will flash three times as confirmation; when it is unlocked, the indicator lamps will flash once.

Operation of Door Lock System (Key)

Key Locking

- Using the remote key to lock: press the lock button on the key to lock the car after closing the doors, bonnet and tailgate.
- Using the mechanical key to lock: partially operate the door release handle, using a suitable flat blade tool, insert the tool into the underside of the trim and carefully remove the door lock trim cover, insert the key into the driver door lock and turn counterclockwise to lock the car.

Key Unlocking

- Using the remote key to unlock: press the unlock button on the key to unlock the car.

- Using the mechanical key to unlock: partially operate the door release handle, using a suitable flat blade tool, insert the tool into the underside of the trim and carefully remove the driver door lock trim cover, insert the key into the driver door lock and turn clockwise to unlock the car.

Note: *If the START/STOP Switch is not placed in ACC or ON/READY position or the remote key unlock is not activated within 15 seconds after the vehicle is unlocked with the mechanical key, the immobiliser alarm will be triggered.*

Note: *If no panels are opened within 30 seconds after the vehicle is unlocked by using the remote key, all doors will automatically re-lock.*

Operation of Door Lock System (Keyless)

The keyless entry system can lock and unlock the doors or open the tailgate as long as you carry the smart key and approach to the car.

IMPORTANT

The smart key must be within 1.5 metres of the vehicle for the keyless system to operate correctly

Keyless Locking

After switching the vehicle power system to OFF using the START/STOP Switch and exiting the car, press the door handle button once before moving away from the car to lock all doors and tailgate (no need to press the lock button on the key). Note, this will also arm the alarm and immobilise the vehicle.

Keyless Unlocking

Press the button on the front door handle once to unlock the car, then pull the door handle to open the door.

Note: *When the vehicle is locked, if you are within the smart key range and operate the door handle button, but carry out no further action, after 30 seconds the vehicle will automatically re-lock itself to remain secure.*

STARTING & DRIVING

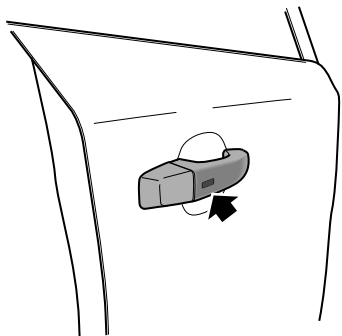

IMPORTANT

After the door is locked by using the key, press the button on the door handle to unlock the car. If the car cannot be unlocked or locked normally, seek an MG Authorised Repairer.

Mislock

If the driver's door is not fully closed when the smart key lock button is pressed, or the vehicle power system has not been switched OFF, the vehicle horn will sound once, indicating a mislock. In this case, none of the doors will lock, the alarm system will not be armed and the direction indicator lights will not flash.

If locking operation is performed when the driver's door is closed but the passenger's door or bonnet and tailgate are not fully closed, the vehicle horn will sound once, indicating a mislock. In this case, the 'partial arming' attributes of the body anti-theft system will enable (all fully closed doors, bonnet or tailgate apertures will be protected, but an open aperture will not!) . As soon as the open aperture is closed, the system will automatically revert to an armed state.

Inadvertent Locking of Keys in Vehicle

If the vehicle is locked using the mechanical key blade or handset whilst a smart key/s remain inside, the following actions will occur:

- One smart key locked in the vehicle - The immobilisation release function of the smart key locked in the vehicle is suspended, the lock and unlock function of the smart key is retained. The vehicle will not change power state. To reinstate the immobiliser release function of the smart key locked in the vehicle the second smart key should be used to unlock the vehicle. The function will automatically be reinstated.
- Both smart keys locked in vehicle - The immobilisation release function of both smart keys locked in the vehicle is suspended, the lock and unlock function of the smart keys is retained. The engine cannot be started. The reinstatement of key functions can only be carried out using the approved diagnostic tool. Consult an MG Authorised Repairer immediately.

Anti-Theft Alarm Sounder

If the anti-theft alarm has been triggered, the car horn will sound continuously. Press the UNLOCK button on the key, the anti-theft alarm will be deactivated.

Interior Lock and Unlock Switch

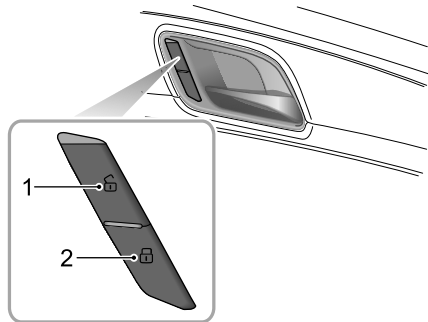

1 Unlock Switch

2 Lock Switch

When the vehicle anti-theft system is not set, press the lock switch (2) after closing all doors to lock all doors; press the unlock switch (1) to unlock all doors.

STARTING & DRIVING

Note: *If the vehicle anti-theft system is set, pressing the lock/unlock switch will not lock/unlock the doors but will trigger the alarm system.*

If the doors, bonnet and tailgate are closed, press the interior lock switch, the yellow indicator on the interior lock switch illuminates.

If a mislock is caused by non-driver door, tailgate or bonnet, press the interior lock switch, the yellow indicator on the interior lock switch illuminates.

Interior Door Handles

Use the interior door handles to open the door:

- 1 Pull the interior door handle once to unlock the door.
- 2 Pull the interior door handle again to open the door.

Speed Lock

All the doors will be locked automatically when the road speed exceeds 10 mph .

Automatic Unlock

When the vehicle power system is switched to the OFF position, all the doors will be unlocked automatically.

Manual Tailgate *



If the tailgate can not be closed due to the type of cargo loaded, be sure to close all windows during driving, select the face distribution mode of the air condition, and set the blower to maximum speed, so as to decrease exhaust fumes entering the vehicle.

The manual tailgate can be opened using the following 2 methods:

- 1 When the car is unlocked or the matched key appears within 1m range around the tailgate, directly press the open switch on the tailgate to open the tailgate (A).
- 2 Press and hold the tailgate open button (B) for more than 2 seconds to unlock and release the tailgate, the tailgate can then be manually lifted open.

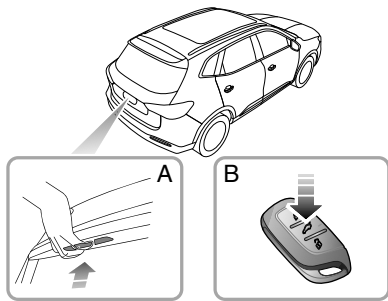

STARTING & DRIVING

Electric Tailgate *



If the tailgate can not be closed due to the type of cargo loaded, be sure to close all windows during driving, select the face distribution mode of the air condition, and set the blower to maximum speed, so as to decrease exhaust fumes entering the vehicle.



Before operating the electric tailgate, ensure no persons, animals or obstructions are within the direct vicinity of the tailgate, they may become trapped between the tailgate and a vehicle or the tailgate and an obstacle. Ensure any items carried in the rear of the vehicle have adequate clearance from the tailgate when closing.

The electric tailgate will only operate when the vehicle is not running or in READY mode and Park is selected.

Whilst the electric tailgate is operating the system will emit an audible warning.

Electric Tailgate Open/Close Mode

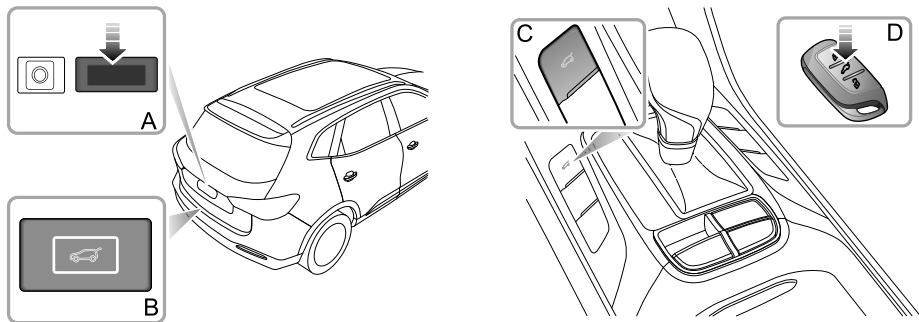

Electric tailgate can be opened or closed using the following methods:

- 1 **Open/Close from outside** : When the vehicle is unlocked or matched key appears within 1 m range around the tailgate, press button A to open the tailgate, press button B to close.
- 2 **Open/Close by smart key** : When START/STOP Switch is in the OFF position, press and hold the tailgate button D on the smart key to automatically open or close the tailgate.
- 3 **Open/Close from inside** : Press and hold the tailgate switch button C in the centre console to automatically open or close the tailgate. (If the vehicle is locked from the outside, switch button C will not operate.)

STARTING & DRIVING

Note: *In certain conditions where the vehicle has been stopped or parked on an extreme incline, the tailgate may not be electrically opened or fully closed due to the change of centre-of-gravity position.*

If the tailgate fails to fully open to its preset height, or fully close, carry out a manual operation to close the tailgate, this will restore the electric tailgate operation.

Note: *During manual operation of the electric tailgate, avoid violent or rapid operation, failure to follow these instructions may result in damage to the power tailgate system.*

When the tailgate is fully closed it will lock in position using the electronic catch.

Anti-pinch Function

Whilst opening the tailgate: In cases where an object that interferes with the tailgate operation is detected, the tailgate will stop opening and return to a safe angle automatically where the obstruction/s can be removed.

Whilst closing the tailgate: In cases where an object that interferes with the tailgate operation is detected,

the tailgate will stop closing and return to a safe angle automatically where the obstructions can be removed.

Note: *If the anti-punch function has been activated multiple times in a brief period, the system will suspend the electric opening/closing function for protection. In this situation, the tailgate can be fully closed once manually so as to reset the function of electric tailgate.*

Note: *If the tailgate is frequently operated in a short period, the system thermal protection may be triggered, causing the electric opening/closing function to be temporarily unavailable. Operation will be suspended for a preset time limit.*

Setting Opening Height for Electric Tailgate

Users can set the opening height of electric tailgate as needed by using the Close button on the tailgate or Infotainment screen. The electric tailgate controller will record the new opening height.

Note: *The opening height setting values of the electric tailgate must be between 40% and 100% of its total stroke.*

Setting mode 1:

- 1 Place the tailgate to desired setting height, and keep it stationary.
- 2 Press and hold the Close button on the tailgate for a minimum of 3 seconds. A buzzer will sound to indicate the successful setting.

Setting mode 2:

Turn on the Infotainment system, enter the height setting interface for the electric tailgate under "Setting" menu, and move the height setting slider to desired position.

Note: *If an electric tailgate system failure occurs, a relevant warning message "Power Liftgate System Fault" and icon will be displayed in the message centre of the instrument pack, please consult an MG Authorised Repairer.*

Tailgate Emergency Open

The tailgate emergency opening mechanism is located inside the tailgate as part of the catch.

Fold down the rear seat to gain access, remove the blanking plug, insert a suitable tool into the opening slot and release the tailgate lock.

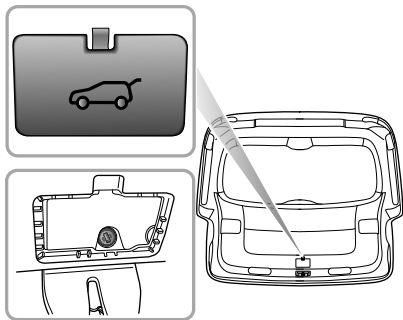

STARTING & DRIVING

Starting and Stopping Power System

START/STOP Switch



The keyless START/STOP Switch is located in the fascia to the right of the steering column, it is a push button style switch. To operate the switch the smart key must be inside the vehicle.

The operational status displays are as follows:

Indicator Off (OFF)

If the switch has not been operated and there are no indicators illuminated, the power system is OFF. The power seats and electric door mirrors remain operational.

Yellow Light (ACC)

Pressing the START/STOP Switch without the footbrake being applied whilst the vehicle power system is OFF will place the system in the ACC state, this will illuminate the yellow indicator in the switch button. The ACC position allows operation of certain ancillaries such as power windows.

Green Light (ON/READY)

- Whilst in the ACC state, pressing the START/STOP Switch without the footbrake being applied will place the system in the ON state, the green indicator will illuminate. This will allow the remaining electrical systems to operate.
- Pressing the START/STOP Switch with P selected and the footbrake applied will place the vehicle in the READY state, the green indicator will illuminate and the word READY will appear in instrument panel information display. This indicates that all electrical

systems will operate and the vehicle is ready to be driven.

Note: *Whilst in the OFF state, if the driver exits the vehicle leaving the smart key inside, the horn will sound three times in quick succession upon closure of the driver's door. Subsequent re-opening of the driver's door will display a warning message in the instrument pack message centre to indicate that the key is still in the car.*

Note: *To remove the electronic shift control lever from P the vehicle must be in an ON/READY state and the footbrake applied.*

If your car is subject to strong radio signals the keyless entry and start systems may suffer from interference and not function correctly. Please see the 'Alternative Starting' procedure.

READY Mode

Setting the power system into READY mode:

- 1 Ensure all unnecessary electrical loads (inc AC) are switched off.
- 2 Ensure the parking brake is applied. (refer to "Brake System" of this chapter)
- 3 Ensure P or N is selected.
- 4 Press the brake pedal.
- 5 Press the START/STOP Switch (do not hold the button in, release immediately).
- 6 The green indicator will illuminate and READY will be displayed in the instrument pack message centre.

Cold Climates

In temperatures of -10°C and below, engine cranking time will increase. It is essential that all unnecessary electrical equipment is switched off while cranking.

STARTING & DRIVING

IMPORTANT

- If the vehicle will not enter a READY state, please check for any warning indicators or messages displayed in the instrument pack message centre. In extremely low temperatures please allow 5 minutes between power up attempts.
- In extremely low temperature, if the power system fails to start up for 3 successive attempts (Ready indicator of the power system fails to illuminate), it is recommended to turn off the power supply and wait for rescue.
- Do not leave the START/STOP Switch in an ACC or ON/READY state for long periods of time, excessive use of electrical equipment may lead to a discharged battery.
- The vehicle is fitted with an anti-theft system. Independently sourced keys may not allow vehicle entry and system power up. Any new keys will require programming using the manufacturers software.

IMPORTANT

- Your car is fitted with complex electronic control systems, please ensure that all other radio transmission or electromagnetic devices are kept away from the smart key and centre console cubby areas. They may cause interference and operational issues.

Alternative Starting Procedure

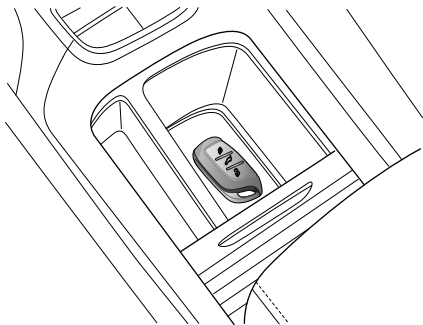

If the car is located in an area where there are strong radio signals causing interference or the smart key battery condition is low, please use the following steps to attempt to start the car:

- 1 Place the smart key centrally in the centre console cup holder cubby box with the buttons facing upward - as shown in the illustration.

- 2 Ensure P or N is selected, press the brake pedal and then press the START/STOP Switch to start the power system.

If the vehicle power system cannot be changed after the car has left the area of strong radio interference or had the smart key battery replaced please consult an MG Authorised Repairer.

IMPORTANT

Application scope of alternative starting procedure:

- The Alternative Starting Procedure should only be required if the smart key battery is very low or flat.
- Once the vehicle has been removed from the area of excessive radio interference the keyless entry and Start Stop systems should return to normal.

STARTING & DRIVING

Switching the Power System OFF

Setting the power system to OFF.

- 1 After bringing the car to a halt, ALWAYS maintain brake pedal application.
- 2 Apply the parking brake.
- 3 Place the shift lever in P position.
- 4 Press the START/STOP Switch to shut down the power system.

Note: Should the power system require to be shut down in the case of an emergency, press and hold the START/STOP Switch in excess of 4 seconds.

Pedestrian Alert Control System

In order to improve the safety, your car is fitted with a Pedestrian Alert System. When the vehicle is travelling in pure electric mode at a low speed, the system controls a speaker that sounds to remind pedestrians in the vicinity of your presence.

Sound Strategies

The speaker sounds when all of the following conditions are met:

- 1 The vehicle is READY;
- 2 The Pedestrian Alert System is fault free;
- 3 During acceleration, the vehicle speed is above 0 mph (0 km/h) and less than 19 mph (30 km/h); during deceleration, the vehicle speed is greater than 0 mph (0 km/h) and less than, or equal to 15 mph (25 km/h).

STARTING & DRIVING

Economical and Environmental Driving

Running-in

The engine, transmission, brakes and tyres need time to 'bed-in' and adjust to the demands of everyday motoring. During the first 900 miles, it is essential that you drive with consideration for the running-in process and heed the following advice:

- Do not allow the engine to exceed 3000 rpm in any gear or the vehicle speed to exceed 72 MPH.
- Do not operate at full throttle or allow the engine to labour in any gear.
- Do not drive at a constant speed (either high speed or low speed).
- Avoid heavy braking where possible.

After 900 miles, engine speeds can be gradually increased.

Environment Protection

Your vehicle has been designed with the latest technology in order to minimize the environmental impact of exhaust emissions.

Economic Driving and Maintenance

The following are some suggestions on saving fuel and extending the life of the vehicles.

- Maintain the correct tyre pressure; insufficient air pressure will accelerate tyre wear and waste fuel.
- Do not carry unnecessary weight. Heavy loads will increase the engine load resulting in higher fuel consumption.
- Avoid engine idling for extended periods.
- Maintain slow and smooth acceleration and avoid harsh acceleration.
- Avoid labouring the engine or over running.
- Avoid continuous acceleration or deceleration. A stop-go driving style will consume more fuel.
- Avoid unnecessary stopping and braking, maintain a steady speed and attempt to anticipate traffic lights.

Note: Keep an appropriate distance from other vehicles to avoid emergency braking and reduce brake pad wear.

- Avoid traffic congestion and jam areas as much as possible.

- Anticipating obstructions and slowing down well in advance, avoids the need for unnecessary acceleration and harsh braking. A smooth driving style not only reduces fuel consumption, but can reduce the emission of noxious gases.
- Do not ride the brake pedal, this can cause premature wear, overheating and increased fuel consumption.
- Maintain an appropriate speed on the highway. Higher speeds use more fuel. Appropriate speed can save fuel.
- Maintain the correct wheel alignment. Avoid collision with the kerb and reduce speed on uneven road surfaces. Out of specification wheel alignment will not only lead to excessive tyre wear, but also increases the engine load and fuel consumption.
- Avoid driving on mud or beaches. This will prevent corrosion of the vehicle underside.
- Maintain the vehicle in accordance with MG recommendations. Dirty air filters, oil etc., will reduce the engine's performance and raise fuel consumption.

Note: *To extend the life of all components and reduce operating costs, regular MG Approved maintenance is needed.*

- Do not stop the engine directly after high speed driving, long ascents or towing a trailer. Allow the engine to idle for 20 to 100 seconds depending upon driving loads and conditions. Avoid hard acceleration on a cold engine.

STARTING & DRIVING

Driving in Special Environment

Driving in Rain or Snow



Emergency braking, accelerating and steering on slippery roads will reduce the vehicle's handling performance and grip.

- When raining the windows may fog, reducing visibility (Use the Air-conditioning demist function).
- Grip will be reduced when it rains, so please reduce speed and drive carefully.
- Reduce speed when it rains.
- Avoid aquaplaning (the effect of a film of water between the tyres and the road) this will effect steering and braking performance.

Driving through Water

Avoid driving through floods after heavy rain, this may lead to serious damage to the vehicle.

Catalytic Converter and Particulate Filter



The temperatures of exhaust systems that contain particulate filters and catalytic converters can be extremely high, DO NOT park on ground where combustible materials such as dry grass or leaves could come into contact with the exhaust system - in dry weather a fire could result.

The exhaust system incorporates a catalytic converter and particulate filter, these help to convert poisonous exhaust emissions from the engine into environmentally less harmful gases. Catalytic converters and particulate filters are easily damaged through improper use, please observe the following precautions to minimise the chance of accidental damage.

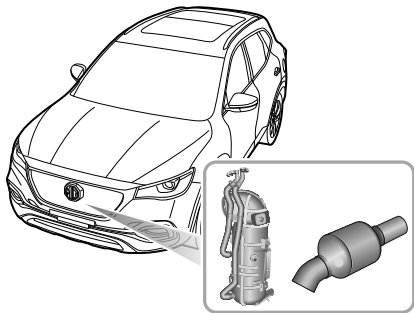

Fuel

- Use **ONLY** fuel recommended for your car.
- Never allow the car to run out of fuel – this could cause engine misfire and serious damage to the catalytic converter and particulate filter.

STARTING & DRIVING

Starting

Pay attention to the following when starting the engine:

- Do not continue to operate the starter after a few failed attempts; consult an MG Authorised Repairer.
- Do not operate the starter if an engine misfire is suspected and do not attempt to clear a misfire by pressing the accelerator pedal.
- Do not attempt to push or tow start the car.

Regeneration

- On occasion the particulate filter may require regeneration. Your vehicle will automatically carry out this procedure when certain conditions are met. During this process you may experience slight power loss and uneven engine running.

Driving

Please pay attention to the following conditions:

- Do not overload or excessively 'rev' of engine.
- Do not stop the engine when the car is in motion with D or a gear selected.

- Consult an MG Authorised Repairer if you think your car's oil consumption is abnormal.
- If a misfire is suspected, or the car lacks power while driving, provided the engine has reached its normal operating temperature, it may be driven SLOWLY (at risk of catalyst and particulate filter damage) to an MG Authorised Repairer.
- Do not drive on terrain likely to subject the underside of the car to heavy impacts.

Note: Any engine misfire, loss of engine performance or engine run-on, could seriously damage the catalytic converter and particulate filter. Regular maintenance must be carried out in accordance with the schedule specified in the 'Service Schedule'. Any modifications to engine without being authorised is prohibited.

Engine Oils

- It is strongly recommended that only oils that meet the manufacturers specification are used. Use of oils that do not meet the manufacturers specifications can damage the particulate filter, for example low SAPS oils can affect particulate filter ash capacity.

Fuel System

Fuel Requirements



Use only the recommended fuel which meets national standard! Serious damage to the catalytic converter and particulate filter, a reduction in engine power/torque and increase in fuel consumption will occur if the wrong fuel is used.

Use the fuel recommended by the manufacturer. See "Main Parameters of Engine" in "Technical Data" chapter.

If a lower grade of fuel is used, an engine knocking noise may occur, please use the recommended or above grade gasoline as soon as possible. If the engine knocking noise is still noticeable after using the recommended or above grade fuel, please contact an MG Authorised Repairer immediately. It is permitted that the octane number of gasoline is higher than that required by the engine, but it is not advantageous for engine output power and fuel consumption.

Safety Precautions in a Fuel Filling Station



Vehicle fuel gases are highly flammable and, in confined spaces, are also extremely explosive.

Always take care when refueling:

- Stop the power system;
- Do not smoke or use a naked flame;
- Do not use a mobile phone;
- Prevent fuel spillage;
- Do not overfill the tank.

STARTING & DRIVING

Fuel Filler

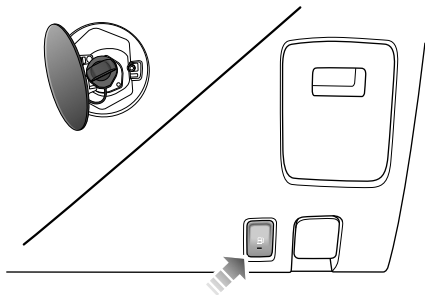

Fuel Filler Flap

Fuel filler flap is located at the left rear of the vehicle. The vehicle uses a high-pressure fuel tank system. The pressure in the fuel tank will be higher than atmospheric pressure. Before opening the fuel filler flap, press the fuel filler flap release switch (located at the bottom right of the driver side lower dash panel) for 2 seconds then

release, the system will start the refueling preparations for pressure relief. Simultaneously the instrument pack will show "Please Wait to Refuel...". After the refueling preparations are completed, the indicator on the fuel filler flap release switch illuminates green, the instrument pack shows "Please Refuel". At this time, you can open the fuel filler flap.

In some rare cases, the fuel filler flap may fail to open within 30 seconds of pressing the fuel filler flap release switch for the first time. This is because the pressure relief process has not been completed. Please press the button a second time. When the fuel filler flap opens, please unscrew the fuel filler cap slowly for refueling. In some cases the fuel delivery nozzle may 'cut off' prematurely, if this continues please consult an MG Authorised Repairer for service as soon as possible.

If either of the following occur, it indicates that the refueling system detected a fault or failed. In this case, please contact an MG Authorised Repairer for service.

- The indicator lamp on the fuel filler flap release switch flashes green;

- The instrument pack shows "Please Service the Refueling System".



Shut down the power system before refueling. If the fuel filler flap release switch is pressed when the engine is running or the pure electric mode is supplied by high voltage, the fuel filler flap will not open, and the instrument pack displays "Please Switch the Engine Off While Refueling". In this case, please shut down the engine first and then open the fuel filler flap.

After the refueling is completed, please close the fuel filler flap immediately, the system will automatically lock the flap after it has been closed for about 5 seconds. At this time, the indicator lamp on the fuel filler flap release switch extinguishes, the corresponding text message disappears from the instrument pack.



If the fuel filler flap is not closed, when the vehicle reaches a certain speed, there will be a voice prompting the driver, and the instrument pack will display "Fuel Filler Flap Open". Please stop the vehicle as soon as conditions and safety permits, and close the fuel filler flap.



Even if the fuel filler flap has not been closed, the release switch will still need to be pressed before refueling. The fuel filler flap can only be opened after the refueling preparations are completed, failure to do so endangers safety.

Fuel Filler Cap

Slowly rotate counterclockwise to release the fuel filler cap.

After refueling, replace the fuel filler cap and tighten till you hear a "click".

STARTING & DRIVING

Refueling

Do not fully fill the tank if the vehicle is to be parked in direct sunlight or high ambient temperatures - expansion of the fuel could cause spillage. The fuel filler tube is designed to accept a narrow, long filler nozzle. A small cover is incorporated within the filler neck, by inserting the filler nozzle thoroughly before fuel filling, the cover can be fully opened.

Start the engine after the fuel filling. If the engine does not run smoothly, shut down and do not start it again, contact an MG Authorised Repairer immediately for service.

Vehicle Hybrid Control

Crash Outage Control

If a crash or serious impact occurs, a signal from the SDM (Airbag Module) will disconnect the relays within the battery management system isolating the high voltage battery from the systems on the vehicle.

Electric Power Management Mode

The vehicle features an electric power management function of the high-voltage battery pack. The driver can select different electric power management modes, and can view the currently selected electric power management mode via the instrument pack. Please refer to 'Electric Power Management Mode' in 'Start & Driving' chapter.

Power Limit of Electrical Appliances

According to the current load conditions and the status of the low-voltage (12V) battery, the vehicle can limit the power of some comfort electrical appliances, such as restricting partial lighting, air conditioning blower. At the

same time, the prompt information will be displayed in the information centre in the instrument pack.

IMPORTANT

If any of the conditions described above occur, please charge the low voltage battery as soon as possible.

STARTING & DRIVING

Charging Requirements



Prior to using any charging equipment please inspect the sockets, plugs and cables for any damage. DO NOT use any equipment that shows signs of misuse or damage.



It is recommended that the charging cable be connected to the charging device before connecting to the vehicle and charging commences.



DO NOT attempt to switch the vehicle power system ON during charging.



After charging completion, switch off the charger (where necessary), disconnect the cable from the vehicle, fit the waterproof blanking plug, close the charging point door. If necessary you can then disconnect the cable from the charger (where applicable).



Whilst charging the car on rainy days, where possible, please avoid connecting the charger during torrential rain or storms. If excessive water is evident around the charging plugs please use a suitable cloth to dry the area as best possible before removing the waterproof blanking plugs and connecting the charging cables.



DO NOT touch the charging connector or charging plug when your hand is wet.



DO NOT stand in water or snow when connecting or disconnecting the charging cable.



DO NOT attempt to charge when the charging connector and plug are wet.



Always keep the charging connector and charging plug in a clean and dry condition. Be sure to keep the charging cable in conditions where there is no water or moisture.



Only use the correct charger for charging the hybrid vehicle. Using any other charger or connector configuration may cause failure.



Take care not to drop the charging connector. This could result in damage.



STOP charging immediately if you find anything abnormal, such as sparks, burning or smoke.



Always hold the charging connector handle or plug when connecting or removing the charging cable, if you pull the cable itself (without using the handle), the internal wires may disconnect or get damaged. This may lead to electric shock or fire.



High voltage charging equipment can cause interference with electronic medical devices. When using medical electrical devices such as pacemakers, please consult your doctor about whether charging your hybrid vehicle will impact the operation of the device. In some instances, electromagnetic waves that are generated from the charger can seriously impact medical electric device operation.



NEVER use a high powered jet wash directly on the charger door or to clean around the charge point.

STARTING & DRIVING

Charging Your Vehicle at Home

Whilst your MG has been supplied with a home charging kit it is essential that you check with a qualified electrician that the infrastructure of your property will support the charging equipment. Please seek qualified advice that your current electrical supply and circuits will support the requirements of the charging equipment.

Installed Charging Points

Various companies will supply and install charging points to your property, MG insist that only qualified reputable suppliers and installers are used - failure to have the correct equipment installed by a qualified professional may result in overloaded circuits and fire.

Home Charging Guide

ONLY use certified approved equipment.

ONLY use qualified suppliers and installers.

When the battery is fully charged, disconnect the cable plug from the vehicle socket - if it is necessary to interrupt the charging of the vehicle, disconnect the vehicle plug first, then isolate the power supply.

NEVER allow water or fluids to enter or contaminate your charger or vehicle charging sockets.

NEVER use damaged charging points, equipment or sockets.

STOP charging immediately if you see anything unusual, smell burning or see sparks. ALWAYS follow the operating instructions supplied with your charging equipment.

ALWAYS follow the operating instructions supplied with your charging equipment.

Charging and Medical Condition Awareness



High voltage charging equipment can create areas of strong electromagnetic interference, this may cause operational issues with electronic medical devices.

When using medical electrical devices such as pacemakers or cardioverter defibrillators (ICD's) please consult your doctor about whether charging your hybrid vehicle will impact on the operation of the device. In some instances, electromagnetic waves that are generated from the charger can seriously impact medical electric device operation.

Note: *There are no cautions issued about medical devices when the car is not connected to a charge point and charging. It is perfectly safe for individuals fitted with pacemakers or cardioverter defibrillators to drive or ride in the vehicle.*

Charging Port

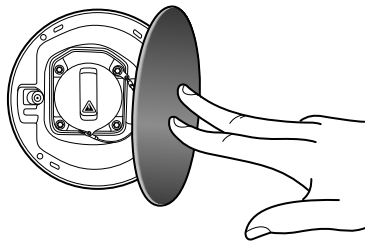

Charging Flap Door

The charging flap door is located rear right of the vehicle, it is incorporated into the master lock system. When the vehicle is unlocked, press the door to release it from the sprung loaded catch. Pull out the waterproof blanking plug then you can access the charging port.

STARTING & DRIVING

Charging Port Electronic Lock

In order to prevent the charging connector and cable being disconnected inadvertently during charging, the charging socket features an electronic locking mechanism.

The electronic lock is activated automatically when certain conditions are met, and remains in a locked state until the car is unlocked.

Note: *After the car is unlocked charging will stop, failure to remove the charging plug within 60 seconds will result in the car re-activating the electronic lock and charging will re-start.*

Manually Releasing the Charging Port Lock in Emergency Situations



The vehicle features an emergency release device for the charging port lock.

To access the manual release, remove the trim plate covering the service access hole on right side of boot - see picture.

Charging Operation

AC Charging Points

IMPORTANT

Please ensure that only charge points that meet IEC 61851 and IEC 62196 are used to connect to your vehicle.

Using an AC charging device:

- 1 Ensure vehicle power system is OFF and all doors are closed.
- 2 Open the charging port door, remove the waterproof blanking plug from the charging plug connector.
- 3 Plug the cable from the charger point into the vehicle. Lock the vehicle.
- 4 After completing charging, unlock the vehicle and disconnect the plug from the vehicle.
- 5 Ensure the charge socket is free from debris, fit the waterproof plug. Close the charging point door.

Note: *If at any time during the charging process you should want to check the state of charge, please switch the vehicle power system to the ON position. The high voltage battery state of charge will be displayed in the message centre in the instrument pack.*

Note: *If the vehicle is unlocked during the charging process, charging will be suspended. Charging will resume when the vehicle is re-locked. If charging does not automatically resume after locking the vehicle, it may be necessary to remove and refit the charger cable.*

Residential Charging

Your vehicle will have been supplied with a residential charging device. This device can be plugged into a standard household 3 pin socket.

During the charging operation the vehicle power system must be OFF. Carry out the following procedure to charge the car using the charger supplied with the vehicle:

- 1 Ensure vehicle power system is OFF and all doors are closed.

STARTING & DRIVING

- 2 Open the charging port door, remove the waterproof blanking plug from the charging plug connector. Ensure the surroundings are clean, dry and free from debris.
- 3 Connect the charging plug to the socket on the vehicle.
- 4 Connect the charging device plug to the domestic electricity supply. Lock the vehicle.
- 5 After completing charging, unlock the vehicle, disconnect the charging cable from the vehicle, and then the domestic plug.
- 6 Ensure the charge socket is free from debris, fit the waterproof plug. Close the charging point door.

Note: *If at any time during the charging process you should want to check the state of charge, please switch the vehicle power system to the ON position. The high voltage battery state of charge will be displayed in the message centre in the instrument pack.*

Note: *If the vehicle is unlocked during the charging process, charging will be suspended. Charging will resume when the vehicle is re-locked. If charging does not automatically resume after locking the vehicle,*

it may be necessary to remove and refit the charger cable.

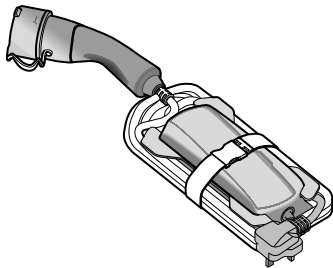

Slow charging kit (supplied with the vehicle)

Charging Information

At the beginning of the charging process, the following information will be displayed within the instrument pack message centre.



- 1 Current Time
- 2 High-voltage Battery Pack Status
- 3 Driving Range by High-voltage Battery Pack
- 4 Charging Status

STARTING & DRIVING

Equalisation Charging

Equalisation charging means that after a normal charging process the battery management system will enter a mode where it will attempt to equalise the charge of every battery cell.

If an equalisation charge has not been carried out for some time the message centre in the instrument pack will display 'Please Slow-Charge the Vehicle'. Please refer to 'High Voltage Battery Pack' in the 'Maintenance' section.

On average it takes at least 5 hours to complete a charge that includes the equalisation charge.

Note: *Ambient temperatures have an effect on charging times, it may take longer to complete a charge when the ambient temperatures are low.*

Charging Times

On average it takes approximately 4.5 hours to charge the high voltage battery from low battery warning to 100% (charge quantity can be checked using the instrument pack).

- At low temperatures the charging time will be extended.

- If an equalisation charge has not been conducted for a long time the required charge time will be extended.
- An equalisation charge must be carried out prior to using the car after a long period of storage or non use. In these cases the charging time will be extended.

Electric Drive Transmission (10-Speed)

Instructions

The following information is very important; please read carefully before use:

- The electric drive transmission is a high voltage unit; DO NOT touch it unless you have the correct training and qualifications.
- Before setting the vehicle in READY mode, place the shift lever in P or N position, ensure the foot brake is pressed and electronic parking brake is applied.
- After setting the vehicle in READY mode, ensure the foot brake and electronic parking brake are applied, shift the lever to the required gear.
- Release the electronic parking brake but maintain foot brake application until you are ready to manoeuvre the vehicle. Once the foot brake is released, on flat road, the vehicle will automatically start off at a slow speed without application of the accelerator.

Gear Shift

Electronic Shift Lever

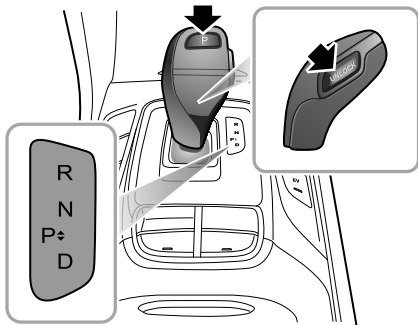

The Electronic Shift Lever features a P (Park) button on the top and an UNLOCK button on the side.

STARTING & DRIVING



Unless necessary, it is not recommended to press the unlock button during gear shifting. This may cause incorrect gear selection and subsequently damage the drivetrain.

The Electronic Shift Lever defaults to the middle steady-state. The forward and backward positions are non-steady states.

Transmission Gears



DO NOT move the shift lever to N in order to coast whilst driving.



During driving, DO NOT move the shift lever from D to R or P position, severe damage to the electric drive transmission or an accident can occur.

- P: Park

In this position, the electronic parking brake is applied.

To release the electronic parking brake, refer to "Electronic Parking Brake (EPB)" in "Brake System" section.

If any gear other than P is selected and the vehicle speed is below 1.2 mph, Park can be engaged using the following procedure:

- 1 Press the P button to engage P gear;
- 2 Turn off the START/STOP switch and the vehicle engages P gear automatically.
- 3 With the brake pedal released and the driver's seat belt unfastened, when opening the driver's door the vehicle engages P gear automatically.

- R: Reverse

Select this gear only when the vehicle is stationary and the engine is running at idle speed.

With the brake pedal depressed, press and hold the UNLOCK button, push the shift lever forward to the end, the vehicle engages R gear.

- N: Neutral

Select this gear when the vehicle is stationary (for example, waiting for traffic lights).

Whilst in P gear, with the brake pedal depressed, press and hold the UNLOCK button, push the shift

lever forward or backward to the first unsteady state position, and the vehicle engages N gear.

Whilst in D gear, push the shift lever forward to the first unsteady state position, and the vehicle engages N gear.

Whilst in R gear, push the shift lever backward to the first unsteady state position, and the vehicle engages N gear.

- D: Drive

This is used for normal driving and will allow automatic selection of drive gears depending on vehicle speed and accelerator position.

Whilst in P gear, with the brake pedal depressed, press and hold the UNLOCK button, push the shift lever backward to the end, and the vehicle engages D gear.

Whilst in R or N gear, push the shift lever backward to the end, and the vehicle engages D gear.

The highlighted letter in the information centre indicates the selected gear.

Kick-down



The drive wheels may skid when kick-down is activated on road surfaces with low adhesion, this may lead to the vehicle sliding out of control.

With D gear selected, pressing the accelerator pedal all the way down in one motion (also known as Kick-down) will provide better acceleration performance during overtaking. Under certain conditions, it will allow the transmission to shift to a lower gear immediately, and provide fast acceleration. Once the accelerator pedal is released, it will resume a suitable normal gear (based on the vehicle speed and the position of the accelerator pedal).

Vehicle Start-off

P is the initial gear position after the vehicle is started. With the brake pedal depressed, after shifting to the desired gear and waiting for the full engagement of the electric drive transmission, release the brake pedal and depress the accelerator pedal to begin vehicle motion.

STARTING & DRIVING

Driving on Hills



In cases where a short stop on a hill is required, such as a traffic jam, DO NOT momentarily apply the accelerator to prevent "roll back". This could cause the transmission to overheat and result in damage.

Hill Start (Start Assist)

In cases of a hill start, where the vehicle has been stationary for some time, the foot brake has been released and the electronic parking brake applied, the starting aid function of the electronic parking brake (EPB) can be used to prevent the vehicle from rolling backwards. With the seat belt safely fastened, press the foot brake, apply the electronic parking brake system, and select the desired gear (D/R), then release the foot brake; press the accelerator pedal to engage vehicle drive, the electronic parking brake system will automatically be deactivated.

Models fitted with Hill Hold Control can use this function to assist hill starts. For details on hill hold control system, please refer to "Foot Brake" of "Brake System" section.

Note: *The aid of these functions cannot defy the laws of physics. DO NOT drive the vehicle beyond its physical limitations, loss of control will still occur.*

Energy Regeneration



Deceleration caused by energy regeneration is NOT a substitute for braking required for safety. ALWAYS prepare for braking to ensure safe driving.

When the vehicle is in a braking, over-run or coasting state, the energy regeneration function is activated, the motor converts part of the kinetic energy of the vehicle into electric energy, which is then stored in the high voltage battery.

Energy cannot be regenerated or is limited under some conditions, such as:

- N gear is selected;
- During torque intervention (gear shifting, tyre skidding, etc.);
- High voltage battery is fully charged;
- High voltage battery temperature is too high or too low.

Electric Power Management Mode

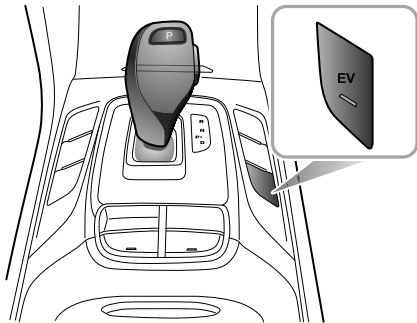

The vehicle features electric power management of the high-voltage battery pack. The driver can manually select different electric power management modes, and can view the currently selected electric power management mode via the instrument cluster.

Switching between “EV” mode and “AUTO” mode can be realised through the EV switch on the centre console.

Switching between “Default”, “Medium battery level” and “High battery level” can be realised through the entertainment system display.

In “EV” mode, the drive motor is powered by the high-voltage battery to drive the vehicle. When “EV” mode is enabled, the instrument cluster displays . Meanwhile, the indicator in the EV switch illuminates.

Only when the following conditions are met can the driver make a forced selection of “EV” mode for pure electric driving through EV switch:

- High-voltage battery power is sufficient;
- A/C system has no heating function request;
- The bonnet is fully closed;
- The hybrid system has no stored faults or codes related to EV (pure electric) mode;
- The vehicle speed is not higher than the maximum speed limit allowed in the pure electric mode.

In “EV” mode, if the conditions are not met, the system will automatically exit and enter “AUTO” mode. The instrument cluster will display a prompt stating: “Exit from EV Mode”. When selecting “EV” mode without meeting

STARTING & DRIVING

the pre-conditions, the instrument cluster will display a prompt stating: “EV Mode Entry Not Support”.

In “AUTO” mode, based on the current high-voltage battery power, power is automatically managed by the system. When “AUTO” mode is enabled, the instrument cluster displays .

“Default” mode is “AUTO” mode.

In “Medium battery level” mode, the engine continuously charges the high-voltage battery in an attempt to maintain approximately 50% battery power. When “Medium battery level” mode is enabled, the instrument cluster displays .

In “High battery level” mode, the engine continuously charges the high-voltage battery to enough power for pure electric or high-power driving in the future. When “High battery level” mode is enabled, the instrument cluster displays .

When the START/STOP Switch is switched off, the vehicle will switch back to last selected mode (EV or AUTO mode) by default.

Protection Mode



When parking the vehicle, please ensure the vehicle is parked safely and that all traffic by-laws are observed.

Overheating Protection



Starting off frequently at high ambient temperatures, quick and frequently accelerating/decelerating, climbing a steep slope for a long period of time, or overloading the electric drive transmission may cause high temperatures. In order to prevent the motor from damage, the system will enter the overheating protection function.

When the system detects electric drive transmission overheating, the warning indicator in the instrument cluster  will illuminate.

In this case, park your vehicle safely or whilst maintaining a light load, continue to drive your vehicle at a constant speed to cool the motor. The vehicle can only be started or driven in different gears after the motor temperature has reduced or warning indicator is off.

If the above-mentioned warning indicator does not go out after the electric drive transmission has cooled down for a long time (about 20 minutes), please stop the vehicle in a safe place and contact an MG Authorised Repairer for assistance as soon as possible, otherwise it may seriously damage the electric drive transmission.

IMPORTANT



When the electric drive transmission is under overheating protection, in order to avoid damage to the motor, the power of the power system will be limited, and the warning indicator in the instrument cluster  will illuminate. In severe cases, the instrument cluster displays “Power Limited, Limiting Speed” and the warning indicator  will illuminate. After decelerating, this will disappear when the electric drive transmission temperature returns to normal.

Motor Malfunction

When the system detects any fault in the electric drive transmission motor or the power electronic box, the warning indicator in the instrument cluster  will

illuminate. In such a case, please contact an MG Authorised Repairer for assistance.

Limp Mode

When some faults occur in the electric drive transmission, the electric drive transmission will enter Limp Mode. At this time, the electric drive transmission can only work in certain gears, the red warning indicator in the instrument cluster  illuminates, and the instrument cluster displays the warning message “Vehicle Control System Fault” simultaneously. After a few seconds, the warning message disappears and the warning indicator  remains ON. In such a case, please contact an MG Authorised Repairer for assistance.

Severe Functional Failure

When some serious functional failures occur in the electric drive transmission, the red warning indicator in the instrument cluster  illuminates, and the instrument cluster displays the warning message “Vehicle Control System Fault” simultaneously. After a few seconds, the warning message disappears and the warning indicator

STARTING & DRIVING

 remains on. At this time, in order to protect the electric drive transmission, the hybrid system will forcibly cut off the power transmission, the vehicle will not be able to drive! In such a case, please contact an MG Authorised Repairer for assistance.

When some serious functional failures occur in the gear shift system, the instrument cluster will display “EP” or P button indicator will flash. At this time, for safe driving, if the vehicle speed is lower than a certain value, the hybrid system will forcibly cut off the power transmission, the vehicle will not be able to drive! In such a case, please contact an MG Authorised Repairer for assistance as soon as possible.

Engine fails to start

When engine intervention is required, the system will attempt to start the engine. If engine starting is not successful, the yellow warning indicator in the instrument cluster  will illuminate. Due to the engine's failure to operate, the vehicle can only be driven in the pure electric mode at this time, attention should be paid to the high-voltage battery power. The instrument cluster will

display a warning message “Engine Fault, Pay Attention to SOC”. In such a case, please contact an MG Authorised Repairer for assistance.

Brake System

Foot Brake

For added safety, the hydraulic braking system operates through dual circuits. If one circuit should fail, the other will continue to function, but greater pedal pressure will be needed, and increased brake pedal travel, and longer stopping distances will be experienced. In the event of a brake failure where only one circuit is operational, the car should be brought to a halt as soon as traffic conditions safely allow. **DO NOT** continue driving - seek an MG Authorised Repairer.

Servo Assistance

The braking system is servo assisted, always be aware of the following during the operation:

- The vacuum booster functions with the power system in READY mode only. Never allow the vehicle to coast when the power system is not in READY mode.
- In pure electric mode, Vacuum to support the system is provided by an electric vacuum pump. **DO NOT** continually pump the brake pedal, this may affect the

vacuum pump efficiency, the braking system may be unable to provide sufficient brake assist.

- If the prompt message "Vacuum System Fault" is displayed in the information message centre, bring the car to a halt as quickly as traffic conditions safely allow and contact an MG Authorised Repairer as soon as possible. At this time, the braking system may be unable to provide sufficient braking force, **DO NOT** drive the vehicle.
- The efficiency of the brake servo booster can be affected by numerous conditions, such as the change of barometric pressure. These conditions could result in extra force required to operate the brake pedal to stop the car.

Wet Conditions

Driving through water or heavy rain may adversely affect braking efficiency. The SCS (Stability Control System) includes a Brake Disc Wiping function which is activated when the windscreen wipers are used. However, always keep a safe distance from other vehicles and intermittently apply the brake pedal in conditions where the wipers are not used.

STARTING & DRIVING

Electronic Brake Force Distribution (EBD)

Your car is equipped with EBD, which, in order to maintain braking efficiency, distributes braking forces between front and rear wheels, under all load conditions.

EBD integrates a monitoring system. The monitoring system is linked to the brake system malfunction indicator lamp on the instrument pack. Refer to "Warning Lights and Indicators" in "Instruments and Controls" chapter.

If the indicator lamp illuminates while driving, or remains illuminated after the START/STOP Switch is turned on (ON/READY position), it indicates there is a failure with the braking system, and EBD may be inoperative. In such a case, stop the car as soon as safety permits and seek an MG Authorised Repairer immediately. **DO NOT** drive the car with the brake system malfunction indicator lamp illuminated.

Electronic Brake Assistance (EBA)

Your car is equipped with Electronic Brake Assist, which reacts to the speed at which the brake pedal is applied. If, in an emergency situation the brakes are applied faster than

the limits set within the system, then full ABS application is applied to bring the car to a stop in the shortest possible distance.

Hill Hold Control (HHC)



HHC has limitations when subject to adverse conditions such as wet or icy surfaces and steep slopes.



HHC is not a substitute for parking brake application when carrying out a hill start. DO NOT exit the vehicle with only HHC applied, it may lead to a serious accident when HHC releases.



The car may roll if 'pull-away' is not achieved immediately after releasing the brake pedal.



Always ensure the brake pedal is pressed or electronic parking brake applied until drive is taken up.



Firm application of the brake pedal when stopping is required by HHC to generate sufficient brake pressure to maintain hold.

Hill Hold Control is a comfort function. It works on inclines when the car detects it has come to a 'stand still status'. It assists the driver by 'holding' the vehicle during hill starts.

The following conditions must be fulfilled to activate HHC:

- The driver's door is closed and the driver seat belt is fastened.
- The vehicle is stopped on a slope in excess of 4%.
- SCS is active and fault free.
- EPB is released and fault free.
- In D or R gear.
- Power system is READY/RUNNING.
- Sufficient brake pedal application force has been applied.

As long as D or R is selected and the brake pedal released, the vehicle will maintain pressure in the braking system for 1 ~ 2 seconds. After this, the Hill Hold will release.

If the driver releases the brake pedal on a hill, HHC will maintain brake pressure for 1 ~ 2 seconds, after this period the vehicle may roll backwards.

Note: HHC is available in both forward and backward directions when pulling away on uphill slopes.

Note: If "Hill Hold Unavailable" is displayed in the information message centre it indicates that the system has detected a fault or another system may be preventing correct operation. Please contact an MG Authorised Repairer as soon as possible.

Note: HHC cannot overcome physical limitations. DO NOT solely rely on HHC.

STARTING & DRIVING

Auto Hold



When auto hold stops the vehicle for reasons such as power system shutdown, releasing the seat belt or pressing the auto hold switch, the electronic parking brake is applied. It cannot be guaranteed that the vehicle will be stabilised in all cases. For example, the rear wheels are on a slippery road surface, or the vehicle incline is too great (larger than 20%). Please make sure that the vehicle is safely stabilised prior to exiting.



The auto hold function cannot guarantee the stability of the vehicle when starting off or braking on hills especially on slippery or icy surfaces.



DO NOT take any extra risks when driving due to the fact the vehicle is fitted with additional convenience functions. The driver should pay full attention and observe the surroundings even if the vehicle is equipped with auto hold system.



DO NOT leave the vehicle when the power system is operating and the auto hold is active.



Auto hold cannot guarantee the electronic parking brake operation in all cases where the power system is turned off. Please ensure the electronic parking brake is applied and the vehicle is stabilised prior to exiting the vehicle.



The auto hold function should be switched off during the use of automatic car washes, the electronic parking brake may suddenly apply and cause vehicle damage.

With the power system active, if the vehicle is required to stop frequently for a length of time (such as traffic lights, traffic queues or stop/start), the auto hold system assists in stabilising the vehicle, enabling you to remove your foot from the brake pedal when the vehicle is stationary and the Auto Hold active.

Auto hold has 3 main states:

- I Off: Function in Off state.

- 2 Standby: Function in Standby state; the function is activated but the vehicle is not parked. Once the vehicle has stopped, and all other conditions are met, the system will automatically select Park.
- 3 Parking: Function in Parked state. In this state the green lamp (P) in the instrument pack illuminates.

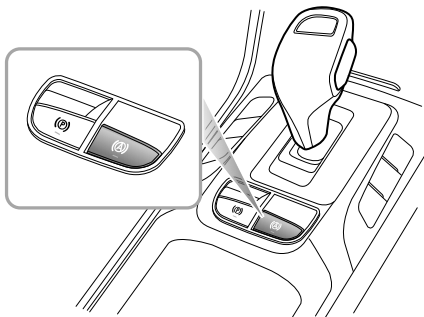

With the driver's seat belt fastened, the door closed and the power system operating, press the auto hold switch to switch the auto hold function from Off to Standby state.

With the brake pedal firmly pressed and the vehicle completely stopped, the auto hold function will switch from the Standby state to the Parking state.

When the auto hold is in the Parking state, engaging D or R and pressing the accelerator will automatically release the auto hold function.

In some circumstances such as releasing the seat belt, switching off the power system or remaining static for a length of time it will result in the vehicle exiting the auto hold Parking state. At this time the electronic parking brake will remain applied and will require the driver to release it using the switch.

Note: *With the brake pedal pressed, operating the switch to turn the auto hold off, the system will NOT apply the parking brake.*

Note: *It is recommended to turn off the auto hold function when reversing into the garage.*

STARTING & DRIVING

Hill Descent Control (HDC)



The HDC system is only an auxiliary function. It has limitations when subject to adverse conditions such as wet or icy surfaces and steep slopes. The HDC system cannot overcome the laws of physics, always ensure that the vehicle is driven down steep slopes at low speeds.



Even when the HDC system is switched on, the driver must always pay close attention to the driving state of the vehicle, and take active control when necessary. In certain cases, HDC may be suspended or switched off temporarily.



During some driving conditions on downhill surfaces (e.g. driving down a slope with high speed, the slope is less than 10%, etc.), HDC is inoperative, the driver must maintain control of the vehicle at all times and use brake applications to ensure safety.

The HDC system is an auxiliary function specially designed for driving on acute downhill gradients. The system reduces the speed by applying brake force, thus assisting the driver to drive on acute downhill surfaces with low speeds.

Please DO NOT use this function when driving on the ordinary roads.

When the HDC is working, the brake system may emit a strong vibration or noise. It is normal during the operation of HDC.

Note: *During the operation of hill descent control (HDC) system, please do not switch the shift lever to "N" position. Such operation may deactivate the HDC function.*

HDC System On/Off

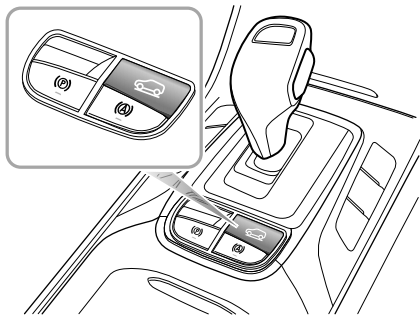

When the START/STOP Switch is placed in the ON/READY position, HDC system defaults to off. Press the button to switch the HDC system ON/OFF.

Normally, HDC system has four states as follows:

- 1 Standby: Press the HDC switch to set the system into standby mode, the green HDC warning lamp in the instrument pack will illuminate.

- 2 Operating: whilst in Standby mode, when the vehicle is driven down an acute gradient, if the accelerator and brake pedals are not pressed and the vehicle is at low speed, the HDC system will automatically enter the operating state. In this case, the HDC warning lamp in the instrument pack flashes green, this may be accompanied by the working noise of the brake system. The HDC system will attempt to maintain the vehicle drive down the acute gradient gently.
- 3 Temporary Deactivation: press the accelerator or brake pedal beyond a preset limit whilst in operating mode and the HDC system will temporarily suspend operation.
- 4 Off: press the HDC switch (OFF) to switch the system OFF, the green HDC warning lamp in the instrument pack will extinguish.

Note: When the vehicle turns at a fast speed whilst on an incline, the HDC system may switch from Standby to Operating mode.

Note: During HDC system operation the braking system will automatically pressurise and maintain

STARTING & DRIVING

pressure. Operation of the brake pedal during this phase may result in a 'kickback' sensation through the pedal. This is normal for HDC operation.

HDC ON/Malfunction Indicator Lamp

Refer to "Warning Lights and Indicators" in "Instruments and Controls" chapter.

Anti-lock Brake System (ABS)



ABS cannot overcome the physical limitations of stopping the car in too short a distance, cornering at too high a speed, or the danger of aquaplaning, i.e. where a layer of water prevents adequate contact between the tyres and the road surface.

The purpose of the ABS is to prevent the wheels from locking while braking, thereby enabling the driver to retain steering control of the car.

The fact that a car is fitted with ABS must never tempt the driver into taking risks that could affect his/her safety or that of other road users. In all cases, it remains the driver's responsibility to drive within normal safety margins, having due consideration for prevailing weather and traffic conditions.

Under normal braking conditions, ABS will not be activated. However, once the braking force exceeds the available adhesion between the tyres and the road surface, thereby causing the wheels to lock, ABS will automatically

come into operation. This will be recognisable by a rapid pulsation felt through the brake pedal.

Braking in an Emergency



DO NOT pump the brake pedal at any time; this will interrupt the operation of ABS and may increase the braking distance.

If an emergency situation occurs, the driver should apply full braking effort even when the road surface is slippery. ABS will ensure that the wheels do not lock and that the car is brought to a halt in the shortest possible distance for the prevailing road surface conditions.

Note: On soft surfaces such as powdery snow, sand or gravel, the braking distance produced by the ABS system may be greater than that for a non-ABS system, even improved steering would be experienced. This is because the natural action of locked wheels on soft surfaces is to build up a wedge of material in front of the tyre contact patch. This effect assists the car to stop.

No matter how hard you brake, you are still able to continue steering the vehicle as normal.

IMPORTANT

ABS can not reliably make up for the driver's mis-operation or lack of experience.

ABS Malfunction Indicator Lamp

Refer to "Warning Lights and Indicators" in "Instruments and Controls" chapter.

Note: The normal (non-ABS) braking system remains fully operational and is not affected by partial or full loss of ABS. However, the braking distances may increase.

Active Rollover Protection (ARP)



The ARP system cannot overcome the laws of physics. It is a driver aid to assist the stability of the vehicle and under extreme conditions. It is not a guarantee that the car will not roll over.

STARTING & DRIVING

In case that the vehicle with high centre of mass due to dynamic driving (such as change lane) or stable driving (such as loop driving) may roll over, ARP brakes the outside wheels to under-steer, thereby preventing the vehicle from rollover.

Note: *During ARP application the steering characteristics of the vehicle may be noticeably different from normal.*

Emergency Braking Hazard Warning Lights Control System (HAZ)

If the vehicle is travelling at high speed and the driver makes an emergency braking manoeuvre, the system will automatically flash the brake lamps to warn the following drivers, thereby effectively reducing the risk of rear-end collision accidents.

Note: *If the hazard warning lights are being operated manually, this suspends the HAZ function.*

When the emergency braking manoeuvre is exited (no severe deceleration detected) then the function will be switched off after a few seconds.

Note: *As the car speed drops to below 6mph and the system no longer flashes the brake lamps, the hazard warning lamps will illuminate automatically. Short press the hazard warning lamp switch or increase your speed to above 12mph for 5s to switch off the hazard warning lamps.*

Electronic Parking Brake (EPB)



In the event of EPB malfunction where EPB release is not possible, please consult an MG Authorised Repairer in order to carry out an emergency manual release of the parking brake.

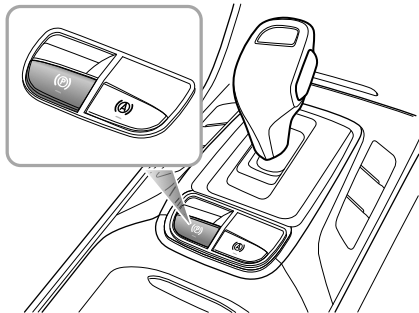

Applying the EPB

When the vehicle is parked safely, selecting P with the gear shift level will automatically apply the EPB. If automatic application of the EPB fails, it is necessary to manually apply the parking brake using the EPB switch

- Pull the EPB switch upward until the indicator in the EPB switch illuminates.
- If the indicator lamp in the EPB switch and the indicator lamp (P) in the instrument pack illuminate, it indicates that the EPB is applied.
- If the EPB MIL (P) in the instrument pack stays on, it indicates that the EPB has a fault. Please contact an MG Authorised Repairer immediately.

Note: An audible motor noise may be heard when applying or releasing the EPB.

STARTING & DRIVING

IMPORTANT

- DO NOT leave the vehicle before the indicator in EPB switch illuminates and the gear indicator displays P, the vehicle may not be safely parked due to EPB failure and slip.
- In the event of a flat battery or power failure it is not possible to apply or release the EPB. If using 'jump leads' to temporarily supply power please see 'Emergency Starting' in the Emergency Information.

Releasing the EPB

If the vehicle is stably parked on a flat road or slight incline/decline, the vehicle power system is READY, press the brake pedal to allow the shift control system to switch from P to N, D or R, the EPB will automatically release.

If on a steep slope, switching from the P position will not automatically release the EPB. In this case, manually release the EPB as follows or apply the start assist function of the EPB to release the EPB.

- Place the START/STOP Switch in the ON/READY position, press the brake pedal, and press the EPB switch;
- The indicator in the EPB switch and the indicator lamp (P) in the instrument pack are extinguished, the EPB is released.

Start Assist

The EPB can predict the driver's intention and automatically release the EPB.

If the driver's seat belt is fastened, the power system is READY, D or R gear is selected and the accelerator pedal is pressed in order to pull away, the EPB will automatically release.

Emergency Braking Function



Inappropriate use of the EPB can lead to accidents and injuries. Do not apply the EPB for vehicle braking, unless in emergency.



During emergency braking using the EPB, DO NOT switch off the vehicle power system, this could result in serious injury.

In the event of normal brake failure, emergency braking using the EPB can be initiated by pulling and holding the EPB switch upward.

- Pulling and holding the EPB switch upward can realise emergency braking. During emergency braking using EPB, an audible warning will sound.
- To cancel the emergency braking process, release the EPB switch.

STARTING & DRIVING

Stability Control System (SCS) and Traction Control System (TCS)

Stability Control System (SCS)

SCS is designed to assist the driver in control of driving direction. The SCS automatically enters Standby mode after the power system is started.

When SCS detects that the vehicle is not moving in the intended direction, it will intervene by applying brake force to selected wheels or through the power management system to prevent sliding and assist in bringing the car back to the right direction.

Traction Control System (TCS)

The purpose of TCS is to aid traction, thereby helping the driver to maintain control of the car in situations where one or both of the driving wheels are spinning (for example, if one wheel is on ice and the other on tarmac). TCS monitors the driving speed of each wheel individually. If spin is detected on one wheel, the system automatically brakes that wheel, transferring torque to the opposite, non-spinning wheel. If both wheels are spinning, the system

will reduce the output torque of the power system in order to regulate wheel rotation until traction is regained.

Switching On/Off

SCS and TCS are automatically switched to standby when the START/STOP Switch placed in the ON/READY position. They can be switched off by using the "Stability Control" switch located within the infotainment system display.

When SCS and TCS are switched off, the Stability Control/Traction Control System OFF warning lamp will illuminate - refer to the "Warning Lights and Indicators" section in the "Instruments and Controls" chapter.

Note: *Disabling SCS and TCS will not affect the operation of ABS. Always disable SCS and TCS when driving with snow chains fitted.*

Stability Control/Traction Control Warning Lamps

Refer to "Warning Lights and Indicators" in "Instruments and Controls" chapter.

If the battery has been disconnected, upon reconnecting the warning lamp will illuminate yellow. Please complete the following steps.

- EPS initialisation, refer to "Steering System" in "Instruments and Controls".
- Switch the vehicle off and restart.
- Drive the vehicle at a speed above 12mph, turning the steering wheel left for 45°, then right for 45°.

STARTING & DRIVING

Tyre Pressure Monitoring System (TPMS)



TPMS can not replace routine maintenance and checks of tyre condition and pressures.



Using equipment that transmits on frequencies similar to that of the TPMS may interfere with the operation of the Tyre Pressure Monitoring System, this may illuminate a warning or register a temporary fault.

Note: TPMS only warns of low tyre pressures, it does not re-inflate the tyre.

TPMS uses pressure sensors built into tyre valves to continuously monitor pressure and transmit data to the ECU inside the vehicle using RF signals. If it deduces that the pressure of that tyre has fallen below the predefined limit of the system, the warning light in the instrument pack will illuminate (always yellow). For more information, please refer to 'Instrument Pack' in 'Instruments and

Controls' section. Check your tyres at the earliest opportunity and reinflate to the correct pressure. Please refer to 'Tyre Pressure (Cold)' in 'Technical Data' section.



If the TPMS malfunction indicator lamp illuminates, and on some models, is accompanied by the warning message "XX Tyre Pressure Low" displayed, it is advised that you please stop the car as soon as possible, check the tyre pressure and inflate the tyre to correct pressure value. Over or under-inflated tyres wear out more rapidly and also have a detrimental effect on the car's handling characteristics. Under-inflated tyres increase the rolling resistance of the car which, in turn, increases fuel consumption. Always check/adjust tyre pressures when they are cold.

TPMS Self-learning

When replacing a TPMS sensor and receiver, or performing tyre rotation, TPMS self-learning is required, please consult an MG Authorised Repairer for details.

Adaptive Cruise Control System

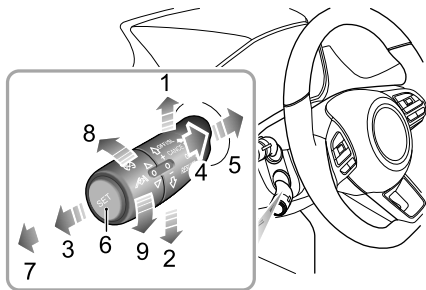

- Speed Limit Increase /Accelerate (1)
- Speed Limit Decrease /Decelerate (2)
- Cancel (3)
- On/Standby (4)
- Resume (5)
- Set (6)
- OFF (7)
- Increase the Distance (8)
- Reduce the Distance (9)



The Adaptive Cruise Control (ACC) system is designed as a comfort system enabling the driver to maintain a constant speed or distance from the car in front. It provides assistance to the driver, it DOES NOT replace any of the drivers responsibilities. When using the ACC it is important that the driver maintains concentration at ALL times.



During the operation of the Adaptive Cruise Control System (ACC) the autonomous braking of the vehicle is limited. Therefore it is ESSENTIAL that the driver maintains concentration, observes the local laws, road and traffic conditions, and if at any time feels there is a danger to themselves or surroundings they should apply the brakes and disconnect the ACC.

The ACC system can automatically switch between constant speed cruise and car following cruise control depending on whether it can detect a vehicle directly ahead. Constant speed cruise control is permitted between 20

STARTING & DRIVING

mph - 90 mph or car following cruise control by setting the distance between the vehicle and the vehicles directly ahead.



When activated if the ACC system detects a car in the same lane directly ahead it may accelerate or gently apply the brakes of the car to maintain the set following distance.

Note: The Adaptive Cruise Control System (ACC) is designed for motorway cruising or any other journey where a constant speed or distance between your car and the vehicle in front can be maintained for a lengthy period.

Adaptive Cruise Control System Activation

The Adaptive Cruise Control system is operated with a lever switch located, at the left side of the steering wheel underneath the indicator/lighting stalk switch.

- 1 With the vehicle START/STOP Switch in the ON/READY position, if the adaptive cruise lever switch is in the 'OFF' position (7), then the adaptive cruise control system is switched OFF.

- 2 Move the adaptive cruise lever switch to the 'ON' position (4), the adaptive cruise system status indicator on the instrument pack  illuminates yellow, and the adaptive cruise control system is in the Standby mode.
- 3 The system will automatically detect the speed and position of the vehicle ahead, if your vehicle speed is above 3 mph, after pressing the 'Set' button (6) at the end of the adaptive cruise stalk lever, the indicator on the instrument pack  will turn green, and the adaptive cruise control system enters the Activated mode, its target speed is the actual speed at activation; if your vehicle speed is less than 20mph, then the target speed of the system is set at 20mph. If the speed of the vehicle ahead is greater than the cruise target speed of your vehicle, your vehicle will maintain the target speed to conduct constant speed cruise; if the speed of the vehicle ahead is lower than the cruise target speed of your vehicle, it will enter the car-following cruise, an image of your car and the car ahead separated by a grid is displayed in the instrument pack message centre, in this mode the actual speed may be less than the set target speed. Whilst in the

car following cruise mode, you can follow the vehicle ahead to a stop, if the amount of time that the vehicle is in a stopped condition is less than approximately 3 seconds your vehicle may automatically pull away to follow the vehicle ahead, if the stopped time exceeds 3 seconds your car will not automatically pull away, you will receive a prompt in the instrument pack message centre requesting you to re-activate the adaptive cruise control using the method displayed.



After following the vehicle ahead to a stop, the driver must observe any local traffic laws and ensure that there are no obstacles or other traffic participants, such as pedestrians, directly in front of the vehicle before allowing it to pull away and begin to follow the vehicle ahead again.



Whilst using the car following cruise function it is strongly recommended that the driver does not touch the accelerator pedal. Any activation of the accelerator will not allow the system to automatically apply the brakes should this be necessary.



DO NOT exit the vehicle when the ACC car following cruise function has stopped, or is keeping the car stationary. Before exiting the car the shift control lever should be in the Park position, the parking brake applied and the power switch in the OFF position.



If the ACC system has already stopped the vehicle, and the ACC function is disabled, turned off or cancelled, the vehicle will no longer stay still, it may move forward or slip backward. When the vehicle is stopped and kept still by the ACC system, be sure to be ready to apply the brakes manually.

STARTING & DRIVING

- 4 If the vehicle speed exceeds the maximum function speed of the ACC, 90mph, the system will automatically switch to the Standby mode, this means that all acceleration and braking manoeuvres must be carried out by the driver according to local traffic laws and traffic and road conditions.
- 5 If the adaptive cruise control system is already in use, the driver should pay special attention in the following conditions, select the appropriate speed, and be ready to take action or apply brakes.

IMPORTANT

When an image of your car and rear end of the vehicle ahead separated by a grid, is displayed in the instrument pack message centre the ACC system will make any necessary response to the vehicle ahead, if the image is not displayed the ACC system will NOT make any response, the responsibility for any manoeuvres rest with the driver.

- Encounters a vehicle or object which is stationary or traversing the lanes.
- Approaching the vehicle ahead too fast, the adaptive cruise control system cannot apply sufficient braking force.
- A vehicle suddenly cuts into the lane in front.
- The vehicle ahead makes an emergency braking manoeuvre.
- An oncoming vehicle crosses the centre of the road and is driving towards you in the same lane.
- Encounters a vehicle driving at a low speed.
- Encounters a vehicle with loaded items protruding from the body side, rear or roof of the vehicle.
- Encounters a vehicle with a higher chassis (e.g., a truck).
- Encounters pedestrians, non-motor vehicles or animals.
- The vehicle is driving on a steep slope, an uneven road or a complex traffic road section.
- The vehicle makes a sharp turn.
- Water or snow splashed by surrounding vehicles hinders camera or radar detection.

- Excessive weight being carried in the boot space or cargo area causing the front of the car to point upwards.
- A fault exists in the system.

Note: *Manual deactivation of either the Traction Control System (TCS) or Stability Control System (SCS) will inhibit the operation of the Adaptive Cruise Control (ACC).*

Adaptive Cruise Target Speed Adjustment

In order to set the target speed, the adaptive cruise control system must be in an active mode.

Use the accelerator pedal to reach the desired speed, short press the 'Set' button (6) on the end of the adaptive cruise switch lever, release the control button and accelerator pedal. The vehicle will cruise at the desired speed.

Move the lever switch upward (1) and hold, the target speed will increase until the desired set speed appears in the instrument pack, then release the switch. When it is confirmed that there is no vehicle in front of your vehicle

or the vehicle ahead exceeds the preselected following distance, the speed will be increased to the set speed.

Move the lever switch downward (2) and hold, the target speed will decrease until the desired set speed appears in the instrument pack, then release the switch. When it is determined that the vehicle ahead driving slowly is within the pre-selected following distance, the vehicle speed will decrease and keep the selected following distance.

Note: *Briefly operate the adaptive cruise lever switch upward (1) or downward (2) once, the target speed will change 5mph, press and hold the lever upward or downward and the speed will increase or decrease in 1mph increments, release the lever when the desired speed reading is displayed.*

Note: *If the vehicle ahead continually makes hard acceleration or deceleration manoeuvres the adaptive cruise control may not be able accurately maintain the required distance between vehicles. It is important that the driver always concentrates and pay attention to the current vehicle position and situation in case they need to make a braking or avoidance manoeuvre.*

STARTING & DRIVING

Adaptive Cruise Target Following Distance Adjustment

When the adaptive cruise control system is activated, rotate the switch on the end of the lever upward (8) or downward (9) to adjust the following distance, you are able to toggle between 3 distance settings, the current following distance setting will be stored by the system until it is changed, and displayed in the message centre in the instrument pack.

Always select an appropriate following distance that is relative to the current speed of your vehicle and the vehicle you are following, the greater the speed, the further the distance. ALWAYS consider current traffic, road and weather conditions when making your selection.

Adaptive Cruise Pause

When the adaptive cruise control system is activated, move the lever switch to the 'Cancel' position (3), and the system will exit to the Standby mode.

Automatic Deactivation of Adaptive Cruise

In the following situations, the ACC may be automatically deactivated, this transfers full control of the vehicle to the driver.

- Move the lever switch to 'Off' position (7).
- Press the brake pedal whilst the vehicle is in motion.
- Move the shift lever away from the D position.
- The driver unfastens his/her seat belt.
- Press and hold the accelerator pedal beyond a preset time period.
- Open any door, bonnet or tailgate.
- Pull the EPB switch up to apply the parking brake.
- Follow the vehicle ahead to a stop and the stop time exceeds 3 mins.
- The sensor or radar view is blocked, the ambient light condition triggers the preset safe exit mechanism of the light sensor, or the system fails.

Note: *If following the vehicle ahead to a stop with the adaptive cruise control system enabled, if any of the following conditions occur whilst the vehicle is in a stopped state, the EPB will automatically be applied:*

- *The driver unfastens his/her seat belt.*
- *The driver door is opened.*
- *The stop time exceeds 3 mins.*

Adaptive Cruise Override

If the driver has cause to use the accelerator pedal when the ACC is activated, the vehicle will remain in Cruise mode while the vehicle speed increases. When the accelerator pedal is released, the ACC will resume to operate at previously set cruise speed.

If the driver accelerates to a higher speed and then releases the accelerator the ACC will decrease to the target cruise speed in a more gradual manner. If it is necessary to decrease to the target cruise speed rapidly, the driver may manually move the lever switch 'Deceleration' (2).

Note: *If the accelerator pedal is pressed and held above the preset time period the ACC may exit to the Standby mode.*

Adaptive Cruise Resume

If the ACC system has reverted to, or been switched to, the Standby mode it can be reactivated by moving the lever switch to 'Resume' position (5). The target cruise speed will automatically be set to the target speed before exiting the adaptive cruise control system.

When driving at a high speed, if the driver resumes to a lower target cruise speed, the ACC will decrease to the target cruise speed in a more gradual manner. If it is necessary to decrease to the target cruise speed rapidly, the driver may manually move the lever switch 'Deceleration' (2).

Clear the Speed Memory

If the lever switch is moved to 'OFF' position (7) or the vehicle START/STOP Switch is switched to the OFF position, the system may clear the adaptive cruise control set speed in the memory.

STARTING & DRIVING

Special Driving Environments

The Adaptive Cruise Control (ACC) system has its limitations. Listed below are some conditions that may be beyond the safe operating limits. The driver should maintain control of the vehicle and must remain alert at all times. They should pay special attention to the traffic conditions and surroundings, select the appropriate speed and be ready to take any required actions.

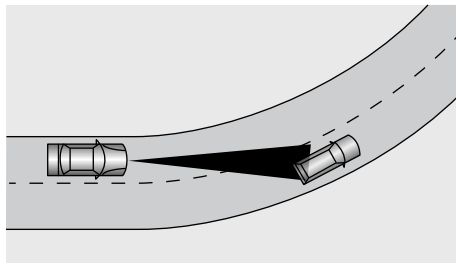
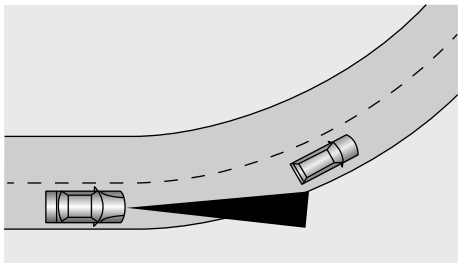

When turning at an intersection or following a vehicle into, or out of a curve, the ACC system may be unable to detect the vehicle ahead, even if it is in the same lane, it is possible the system may detect a vehicle in another lane.

Note: Do not use the adaptive cruise control system on entrance/exit ramps or sharp bends.

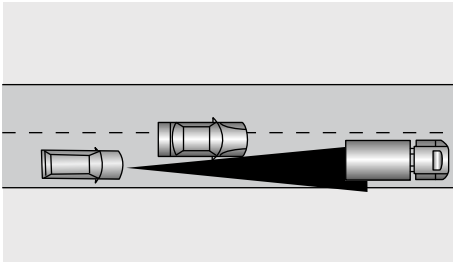

If the vehicle ahead changes lanes, but does not drive into the lane completely, the ACC system may be unable to detect the vehicle.

If the vehicle ahead changes lanes, but does not exit the lane completely, the adaptive cruise control system may determine that the vehicle ahead has exited the lane and accelerate to any preset speed.

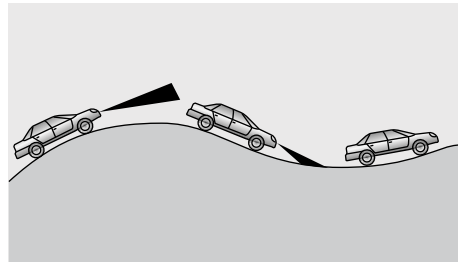

When driving on uneven roads that may include steep climbs or dips please **DO NOT** use the ACC system.

STARTING & DRIVING

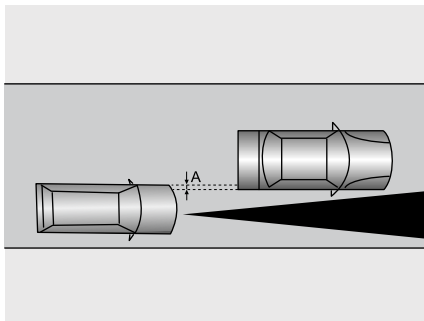

When driving behind a vehicle that is only partially overlapping your vehicle, 'A' in the graphic, the ACC system may be unable to detect anything.

Note: Please DO NOT use the adaptive cruise control system in the following situations:

- *The ambient light level is insufficiently low, extremely bright, or the forward lighting of the vehicle is poor or compromised.*

- *The front view camera in the windscreen and/or radar sensor in the front bumper have a restricted field of vision, or severe weather such as heavy fog, heavy rain, heavy snow, ice, etc are affecting the sensor's field of view.*
- *In conditions where the demist function of the windscreen is impaired.*
- *When driving the vehicle on a low-friction road (rapid changes in tyre traction may result in excessive wheel slip).*
- *When driving on a strong reflective road surface as a result of rain, snow, or ice.*
- *When the radar may be affected by electromagnetic interference (for example, metal objects such as rails and metal plates for road construction).*
- *After the position of radar has changed (for example, collision, vibration).*
- *Radar signals could be incorrectly reflected by local conditions (e.g., in multi-storey car parks, tunnels, water jets from sprinklers, etc.) these may degrade the function of the radar sensor.*

Parking Aid System

Ultrasonic Sensor Parking Aid



The purpose of the parking aid is to assist the driver in reversing! The sensors may not be able to detect obstacles of certain type, e.g. narrow posts or small objects no more than a few inches wide, small objects close to the ground, objects above the tailgate and some objects with non-reflective surfaces.



Keep the sensors free from dirt, ice and snow. If deposits build up on the surface of the sensors, their performance may be impaired. When washing the car, avoid aiming high pressure water jets directly at the sensors from close range.

Rear Parking Aid

The ultrasonic sensors in the rear bumper monitor the area behind the vehicle to search for obstacles. If any obstacle is detected, the system will calculate its distance from the

rear of the vehicle and communicates the message to the driver by sounding warning chimes.

Parking Aid in Operation

When the START/STOP Switch is in the ON/READY position, the rear parking aid is enabled automatically when reverse gear is selected, it is switched off as soon as reverse gear is disengaged. A short beep is given by the parking aid within 1 second after selecting reverse gear to indicate that the system is operating normally.

Note: *If a longer, higher pitched sound is emitted for 3 seconds when reverse gear is selected this indicates a fault in the system. In this case seek assistance from your MG Authorised Repairer.*

With the parking aid enabled, when obstacles are detected, the system will give sounds in different frequencies (there might be blind areas).

STARTING & DRIVING

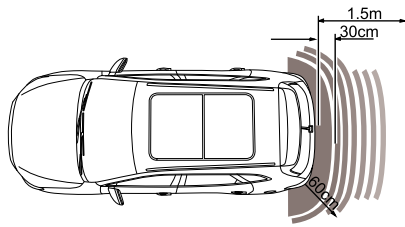

- If an obstacle is located within 1.5m range of the rear parking aid sensors or within 0.6m range of the corner sensor, the warning commences. As the car moves closer to the obstacle, the audible sounds are transmitted more rapidly.
- Once the obstacle is within 30cm range of the rear bumper, the audible sounds will merge into a continuous warning.

360 Around View System



The purpose of the 360 around view system is to assist the driver during parking! The cameras have a limited field of view and cannot detect obstructions outside the field of view.



Although the entertainment display can provide high-definition images around the vehicle, please still pay attention to the current actual road conditions for your driving safety.

With the 360 around view system activated, the display interface will show a 360° panoramic image of the vehicle to facilitate the observation of the surrounding environment in order to assist with safer driving.

- When the reverse gear is selected, the system will automatically switch to the 360° around view display screen, this will appear in the entertainment display.

STARTING & DRIVING

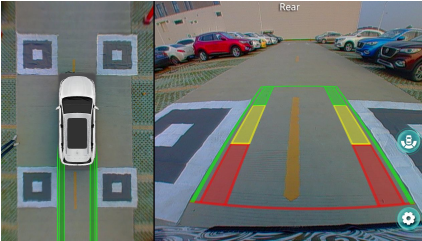

- Touch or press the 360° View button in the centre console to enter into the display interface of the 360 around view system, you are then able to touch buttons on the display to check images from different angles of view of the vehicle to provide a much safer driving environment.
- Touch the icon located in the upper RH corner of the screen to switch between 2D and 3D modes. The 3D mode offers various graphical displays, the 2D mode allows you to view the front, rear, left or right of the vehicle. Touch the icon in the right of the screen to toggle between wheel side, forward wide and rearward wide angle views from the vehicle.

Touch the settings icon in the lower right corner to enter the setting interface:

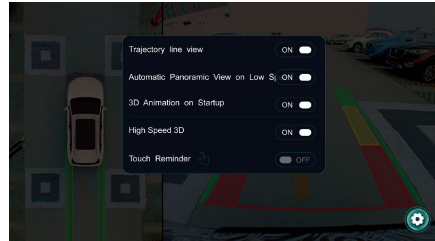

- **Trajectory Line View:** This allows the projected trajectory line display to be switched ON or OFF.
- **Automatic Panoramic View on Low Speed:** When the vehicle is travelling at less than 13mph the system can be configured to automatically open the 360 around view interface when the indicators are activated and exit when the indicators are cancelled. This function can be switched ON/OFF.
- **3D Animation on Startup:** The function of starting the 3D view upon booting can be switched ON/OFF.

STARTING & DRIVING

- High speed 3D: The 3D display view operation at higher speeds can be switched ON/OFF (more than 13mph and less than 20mph). When the function is turned on, the vehicle will switch to the 3D display view automatically when the speed exceeds 13mph, it will switch to the 2D display view after the speed drops to 10mph, it will exit the around view system automatically when the speed exceeds 20mph.
- Touch Reminder: Touch reminder in display can be turned on or off.

Note: *When the shift lever is placed in D, the 360 around view system is inhibited at speeds above or equal to 20mph.*

Rear Driver Assistance System

System Overview



The rear driver assistance sensors may misidentify some surroundings, such as roadside buildings or guardrails and provide a false alarm.



The effective recognition capabilities of the rear sensors can be limited by objects such as roadside buildings, guardrails, changes in pitch angle of the car due to heavy loading, road conditions such as bends or bumps or weather conditions such as snow and ice etc. Any of the above may trigger a false alarm.



The rear driver assistance function is only an aide, it is NOT a substitute for the attention of the driver. The driver must always remain in control, observe the surroundings and drive safely.



The rear driver assist system may not provide adequate warning of very fast approaching vehicles or operate correctly on tight curves of radius.



The rear driver assist system will not operate correctly whilst towing a trailer or caravan.



The correct operation of the rear sensors will be compromised if they are misaligned due to accident damage. This may cause the system to automatically shutdown.



To ensure that the radar sensors work correctly, the rear bumper should be kept free of snow and ice and must not be covered.



Use of non recommended materials or paint on rear bumper repairs may have a detrimental effect on the operation of the rear sensors. Please only use recommended materials.

STARTING & DRIVING

The rear driver assistance system includes blind spot detection (BSD), lane change assist (LCA), rear cross traffic alert (RCTA) and door open warning (DOW) functions.

The rear driver assistance modules are mounted at the rear of the vehicle on each side, they can assist in detecting vehicles behind or to the side of your vehicle.

The warning lamps to support this system are located within the LH and RH door quarter light trims, they will illuminate or flash to warn of an approaching object or car to assist you in manoeuvring the car safely.

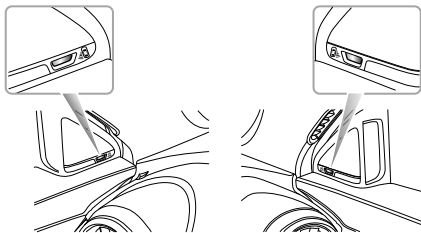

Note: *The radar requires calibration on new vehicles and on vehicles where a rear detecting radar sensor has been replaced. The rear detection radar sensors possess an automatic calibration function to compensate for installation errors within a certain range. When the vehicle is in the ON/READY mode, the radar will automatically enter the calibration state. During the calibration process, the system will provide limited functions, and the alarm may be inaccurate. Upon completion of the calibration, the system will resume all functions.*

Switching the System Functions On/Off

The rear driver assist system function switches can be accessed via the infotainment screen. Select ON/OFF to activate/deactivate the system.

System Functions

Blind Spot Detection (BSD)

When the vehicle is driving forward, the system will monitor for motor vehicles located in the blind zones of the left and right exterior mirrors. When the conditions for activating the blind spot detection function are met, the corresponding warning lamps will illuminate. Subsequent operation of the relevant indicator will cause the warning lamp to flash to remind the driver of an approaching vehicle.

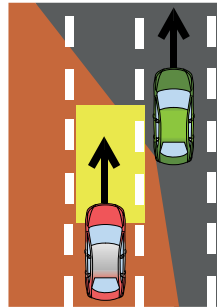

The conditions for activating the blind spot detection function include:

- 1 Rear driver assistance system is in the ON state and no faults are present in the system.
- 2 Blind spot detection (BSD) function is enabled.
- 3 The vehicle speed is above 20mph.
- 4 There are motor vehicles in the blind zone of the vehicle. The system monitors both the left and right

STARTING & DRIVING

of the vehicle, the monitored areas are 2m ahead , 7m behind the rear of the vehicle, and 4.7m from the side of the vehicle.

Note: *The warning lamps will not illuminate whilst you are overtaking another vehicle and your speed is greater than that of the vehicle you are passing, even though it is in the blind zone.*

Lane Change Assist (LCA)

When the vehicle is driving forward, the system will monitor for motor vehicles approaching rapidly in the adjacent lanes. When the indicators are activated, and the conditions for activating the lane change assist function are met, the system will flash the respective warning lamp to warn the driver of an approaching vehicle. This aims to help avoid collisions when changing lanes.

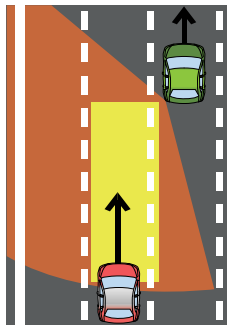

The conditions for activating the lane change assist function include:

- 1 Rear driver assistance system is in the ON state and no faults are present in the system.
- 2 Lane change assist (LCA) function is enabled.
- 3 The vehicle speed is above 20mph.
- 4 The speed of the approaching vehicle is higher than the speed of your vehicle.
- 5 The approaching vehicle enters the detection area of the LCA, the monitored areas are 7m - 70m behind your vehicle and 4.7 m to the side of your vehicle.
- 6 The approaching vehicle is likely to have a collision with your vehicle within 3.5 seconds.

Rear Cross Traffic Alert (RCTA)

When the vehicle is reversing, the system will monitor vehicles approaching from the left and right rear. When the conditions for activating RCTA function are met, the warning lamps on the corresponding side will illuminate, simultaneously a warning triangle icon for the corresponding side will be displayed in the infotainment screen to alert the driver to the situation.

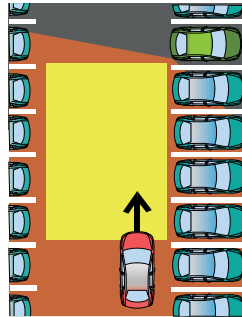

STARTING & DRIVING

The conditions for activating the rear cross traffic alert function include:

- 1 Rear driver assistance system is in the ON state and no faults are present in the system.
- 2 Rear cross traffic alert (RCTA) function is enabled.
- 3 The vehicle is in Reverse gear.
- 4 The vehicle speed is less than 5mph.
- 5 The speed of the vehicle being monitored is above 5mph.
- 6 The motor vehicle drives across the system detection areas. The areas monitored to the left and right of the vehicle are 5m behind the rear of the vehicle, and 25m from the side.
- 7 The approaching vehicle is likely to have a collision with your vehicle within 2.5 seconds.

Door Open Warning (DOW)

Whilst the vehicle is stationary, the Door Open Warning system monitors the surrounding area for approaching vehicles, motorcycles and bicycles.

If the approaching object meets the conditions programmed into the system the corresponding warning light will illuminate to warn the occupant of the approaching object and assist in avoiding any collisions when the door is opened.

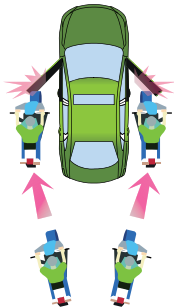

The conditions for activating the door open warning function include:

- 1 Rear driver assistance system is in the ON state and no faults are present in the system.
- 2 Door open warning (DOW) function is enabled.
- 3 The vehicle is in ACC or ON/READY state.
- 4 The vehicle is in stationary.
- 5 The speed of the vehicle being monitored is above 5mph.
- 6 The vehicle drives across the system detection areas. The detection areas are: Rearward of the door mirrors and 2.4 metres from each side of the vehicle.
- 7 The approaching vehicle is likely to have a collision with your vehicle within 2.5 seconds.

Note: *The detection area, collision time threshold value and vehicle speed provided in the system function description are just for your reference.*

STARTING & DRIVING

Driving Assist System

The driving assist system includes Speed Assist System (SAS), Lane Departure Warning System (LDW), Lane Departure Prevention System (LDP), Lane Keeping Assist System (LKA), MG Pilot System, Forward Collision Warning System (FCW), Automatic Emergency Braking System (AEB) and Automatic Emergency Braking System for Pedestrians (AEBP). Under certain conditions, the driving assist system can detect the road and environmental information ahead of the vehicle by utilising a front view camera and a front detection radar. This information is used to relay warning messages or provide assistance to help the driver control the vehicle more safely and reliably. The front view camera is located at the upper middle of the windscreen (in the interior rearview mirror base cover) , the front detection radar is located at the lower middle of the front bumper.

Description of Front View Camera

Calibration of front view camera

The front view camera will require re-calibration after any of the following operations:

- Removal and refitting of the front view camera.
- Replacement of the windscreen.

Note: The calibration of front view camera requires professional knowledge and tools. If calibration is required, please seek an MG Authorised Repairer.

Note: After completing the calibration it is not possible to immediately select any driving assist options. The vehicle power system must be switched to the OFF position and then switched to ON/READY.

Obstruction of the front view camera

On occasion the front view camera view may become obstructed by foreign objects or stains on the glass. In these cases a prompt message will appear in the information centre. Please clean or wipe immediately.

In the following situations, the detection performance of front view camera will be affected:

- Driving in poor weather conditions where visibility is reduced due to thick fog, heavy rain or snow etc.
- The front view camera is affected by light, for example low light levels at night, poor auxiliary lighting, excessive backlighting in the view, light from oncoming vehicles, abrupt change of brightness such as a quick bright/dark jump (tunnel entrance/exit), driving on surfaces with strong reflective properties (road surface covered with water or snow), or driving in places with insufficient light, such as tunnels, surrounded by tall buildings, underground parking lots, etc.
- The front view camera is partially or fully blocked by obstacles, e.g. dust, foreign objects on the windscreen.
- The windscreen in view is damaged.
- Not calibrated after removing/refitting the front view camera.
- Not calibrated after removing/refitting the windscreen.
- The front view camera is not secured in place.

- The outer surface of the windscreen is not clean (including wiper sweep).
- The windscreen is not cleaned regularly.
- The demist/defrost action on the windscreen is inefficient in wet conditions.

Description of Front Detection Radar

Calibration of front detection radar

Front detection radar re-calibration is required after any of the following:

- Front detection radar mis-alignment failure, for example the position of the front detection radar has changed.
- Remove/refit the front detection radar or radar bracket.
- Remove/refit the front anti-collision beam.
- The four-wheel alignment parameters or the driving axis have changed.

Note: *If the front detection radar is subject to strong vibration or slight impact, the mounting position of the front detection radar needs to be checked and re-calibrated as necessary.*

STARTING & DRIVING

Note: *The calibration of front detection radar requires professional knowledge and tools. If calibration is required, please seek an MG Authorised Repairer.*

Front radar performance will be effected in the following situations:

- When the front detection radar is covered by mud, snow, excessive water (rain) or water spray from the road.
- When the radar or surrounding areas are covered by objects such as self-adhesive labels or auxiliary lamps.
- Some targets may affect and weaken the detection capability of the front detection radar, such as road barriers, fences and tunnel entrances.
- When the front detection radar is subject to strong vibration or slight impact.
- When the front detection radar is affected by the environment, such as strong electromagnetic field interference or due to the target itself.

Note: *Any snow that gathers on the front radar may be removed using a soft brush, and any ice should be removed using a propriety deicing spray.*

Note: *Avoid any collision or contact with the front radar module, this may cause misalignment. Any damage, however slight, may cause system performance issues.*

Speed Assist System (SAS)



The intelligent speed limit is an auxiliary function, it may display an incorrect speed limit value or no speed limit value in the instrument pack due to various factors. As a result, the vehicle speed is not restricted within the correct range. The driver still needs to observe the speed limit of the road traffic, and speeding is strictly prohibited.



*The front view camera cannot recognise speed limit signs painted on the road surface. The driver **MUST** observe these speed limits and adjust their speed accordingly.*

The speed assist system settings are available via the infotainment system. When the adaptive cruise control system is OFF, the following three functions can be selected:



- 1 Speed Limit Information Function (SLIF): The vehicle detects a speed limit sign (as shown above) at the roadside with the front view camera. The speed limit sign identified will be displayed in the instrument pack. When the vehicle speed exceeds the speed limit by a preset amount, a visual warning in the instrument pack will flash.
- 2 Manual Speed Assist (MSA): The driver sets the maximum speed using the adaptive cruise control lever. The system will actively intervene and keep the vehicle speed within the permitted maximum speed limit. An acoustic warning and a visual warning will be utilised during the intervention. Please refer to the section “Speed settings of manual speed assist”.
- 3 Intelligent Speed Assist (ISA): The vehicle detects a speed limit sign (as shown above) at the roadside with the front view camera. The speed limit sign identified will be displayed in the instrument pack. The system will automatically intervene and maintain speed control to keep the vehicle speed within the permitted maximum speed limit. An acoustic warning and a visual warning will be utilised when over speed.

STARTING & DRIVING

Speed assistance system setting

The operating interface for the speed assistance system is located in the infotainment display. Enter the vehicle setting interface to locate the driving assist option, scroll across the page to find the setting interface for the speed assistance system:

- 1 Touch the corresponding button on the infotainment display to select the speed assist mode: speed limit information function, manual speed assist and intelligent speed assist.

Speed settings of manual speed assist:

After the manual speed assist function is enabled, the speed limit value can be set by using the adaptive cruise control lever as follows:

- 1 Moving the control lever up to adjust the speed limit. After the speed limit value is displayed in the instrument pack, press the SET button (3 in the figure below), the manual speed assist function will be activated. When pressing the SET button, if the actual speed value is smaller than setting, the speed limit value displayed in the instrument pack will be defined

as setting. If the actual speed value is larger than speed limit adjusted, the speed limit value displayed in the instrument pack will be defined as the current actual speed and rounded to the nearest value of 5mph (62mph will be defined as 65mph). The speed range is 20mph - 80mph. Moving the lever up or down once will increase or decrease the speed limit value by 5mph. Holding the lever up or down will continuously change the speed limit value in units of 5mph.

- 2 After the manual speed assist function is activated, the system will actively intervene and keep the vehicle speed within the target speed limit. If the current actual speed exceeds the target speed limit value set by the driver, the system will reduce the speed until it is below the target speed limit.
- 3 After the manual speed assist function is activated, the driver can press the SET button (3 in the figure below) on the adaptive cruise control lever to reinstate the system to standby state. Press the SET button again, the manual speed assist function will be resumed.

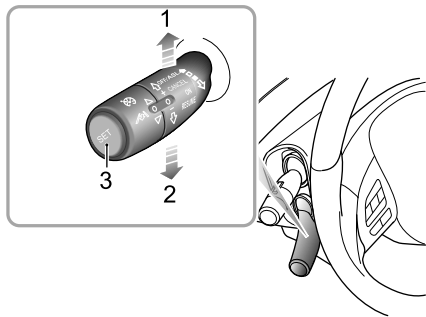

When the speed limit information function or intelligent speed assist function is enabled, the speed limit value indication illuminates. The “NNN” is displayed as “—”. When the vehicle passes the first speed limit sign identified, the speed limit indication displays the real-time speed limit value.

Note: When the vehicle needs to change lane, make a turn or turn around at an intersection and the driver uses an indicator in advance and slows down, the original speed limit value on the instrument pack will be reset and displayed as “—” until a new speed limit sign is detected. If the conditions are not met, the original speed limit value will be maintained and not be reset. The driver **MUST** observe the speed limits and adjust their speed accordingly.



When the national speed limit sign is identified and the speed limit information function or intelligent speed assist function is enabled, the national speed limit indication illuminates. These two functions will work using 60mph as the national speed limit.



When the intelligent speed assist function is enabled, the system indicator lamp in the instrument pack illuminates green. If the intelligent speed assist function detects a fault or failure, the indicator lamp will flash yellow then extinguish. Please try to restart this function. If

STARTING & DRIVING

this function cannot be turned on, please contact an MG Authorised Repairer.



When the speed limit information function or intelligent speed assist function is enabled, and the front view camera detects a speed limit sign with text message below, the warning lamp illuminates yellow to remind the driver to recognise the text message by themselves. The camera cannot recognise the text messages provided below the speed limit sign, such as auxiliary lane, 100m ahead, school section, 7:00-10:00. The camera will recognise the speed limit sign with text messages as a normal speed limit sign. The driver is required to make correct judgement according to the text message.



When the manual speed assist function is enabled, the system indicator lamp in the instrument pack illuminates yellow. When the function is activated by pressing the SET button on the adaptive cruise control lever, the system indicator lamp illuminates green. If the actual speed exceeds the maximum value that can be set, the system will remain in the standby state, and the

indicator lamp remains yellow. If the manual speed assist function detects a fault or failure, the indicator lamp will flash yellow then extinguish. Please try to restart this function. If this function cannot be turned on, please contact an MG Authorised Repairer.

NNN
mph

When the manual speed assist function is enabled, the speed limit value indication illuminates. The “NNN” is displayed as “—”. Move the adaptive cruise control lever up and down to adjust the target speed limit value. The “NNN” will now show the adjusted speed limit value.

The driver can directly switch off, or temporarily suspend the speed assist system by carry out the following actions:

- 1 To temporarily exceed the speed limit (overtaking manoeuvre), press the accelerator pedal hard. The indicator lamp in the instrument pack illuminates green, and the speed limit value flashes.
- 2 Gently press the SET button on the end of the adaptive cruise control lever, the indicator lamp in the

instrument pack will change to yellow. Press the SET button again to resume the functions.

- 3 Move the adaptive cruise control lever to the “ON” position to switch the speed assistance system off. Then the indicator lamp in the instrument pack will extinguish.

The speed limit information function and intelligent speed limit function may be impaired in the following situations:

- 1 The detection performance of front view camera is affected.
- 2 The vehicle is driven at a high speed.
- 3 The speed limit signs are obscured by trees along the road, ice/frost, snow, dust, etc.
- 4 The speed limit signs are incorrectly placed or damaged.
- 5 There are multiple speed limit signs above the lane or on the sides of the road. Currently, the front view

camera can only recognise the speed limit signs for the lane in which the vehicle is being driven.

- 6 Non standard speed limit signs or signs that contain additional information.
- 7 The speed limit signs set up at a fork in the road, on a bend or on-ramp/off-ramp.
- 8 During manoeuvres such as lane-changing.

IMPORTANT

- The camera may not correctly recognise speed limit signs during poor lighting conditions, bad weather, non-standardized or sheltered speed limit signs or the camera's own restrictions which include the recognition of similar signs (e.g., recognise a weight limit sign as a speed limit sign, or recognise a minimum speed sign as the maximum speed sign).
- Some drastic or rapid steering operations made by the driver may be judged as changing lane or turning around at an intersection by the system. This will result in the identified speed limit signs being cleared.

STARTING & DRIVING

Lane Departure Warning System (LDW)



The lane departure warning system is an auxiliary system that provides assistance to the driver. It does NOT remove the responsibility of safe driving from the driver. When choosing to use the lane departure warning system, the driver MUST always pay attention to the surroundings, hold the steering wheel and be prepared to make manoeuvres at any time. Failure to maintain overall control of the vehicle may result in an accident or personal injury.



The lane departure warning system does not always recognise the lane line. Sometimes poor road surfaces, certain road structures or objects may be mistaken for lane lines. When such situations occur, the lane departure warning system must be immediately turned off.

The lane departure warning system uses the front view camera to detect the lane lines ahead of the vehicle. The system will operate when the following detection conditions are met:

- The function is switched ON.
- Vehicle speed is above 37mph.
- Lane line markings are clear.

As long as the system recognises at least one lane line the indicator lamp in the instrument pack will illuminate green. When a wheel is about to cross the lane line, or has already crossed the line, the following warnings will be provided to prompt the driver to take action and maintain the vehicle position between the lane lines:

- An audible warning sound is emitted.
- A visible warning depicting a car passing a lane line is displayed in the information message centre in the instrument pack.
- The steering wheel produces a vibration warning.

The function will automatically exit when the vehicle speed drops below 33mph.

Lane departure warning system setting

The operating interface for the lane departure warning system is located in the infotainment display. Enter the vehicle setting interface to locate the driving assist option, scroll across the page to find the setting interface for the lane assist system:

- 1 Touch the corresponding button in the infotainment display to turn the lane assist system ON/OFF. Select alert in the assist mode to switch the lane departure warning system ON. The system defaults to the last selected state from when the START/STOP Switch was ON/READY.
- 2 Touch the corresponding button in the infotainment display to turn the audible alert ON/OFF. The system defaults to the last selected state from when the START/STOP Switch was ON/READY.
- 3 Touch the corresponding button in the infotainment display to adjust the alert sensitivity. The system defaults to the last selected state from when the START/STOP Switch was ON/READY.

- 4 Touch the corresponding button in the infotainment display to turn the vibration alert ON/OFF. The system defaults to the last selected state from when the START/STOP Switch was ON/READY.

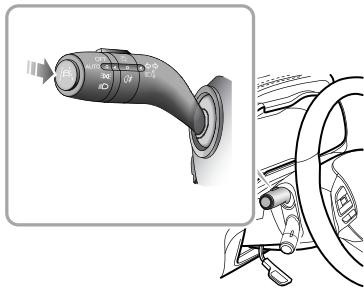

Having turned the lane departure warning system on in the infotainment display, press the button at the end of the indicator stalk switch (as shown above). The lane departure warning system will enter the standby or active

STARTING & DRIVING

state. The system defaults to the last selected state from when the START/STOP Switch was ON/READY.

When the lane departure warning system is in the standby or active state, you can temporarily disable the function by pressing the button at the end of the indicator stalk switch (as shown above). Pressing the button again will resume the function.



When the lane departure warning function is enabled, the indicator lamp illuminates yellow. When the function is enabled and the vehicle speed is above 37mph, the indicator lamp turns green. When the function is disabled, the system indicator lamp extinguishes. If the lane departure warning system detects a fault or failure, the indicator lamp will flash yellow for 90s, and then remain on.

The lane departure warning system will be impaired in the following conditions:

- The front view camera is obstructed or it is impossible for the camera to detect the lane line ahead due to weather and environmental factors.
- The lane line is too thin, damaged, or fuzzy.

- The vehicle is driven on the bend with a small curvature radius.
- The width of the road is too narrow or too wide.
- The vehicle is driven on a road section without lane lines.
- The vehicle has just entered a road section with lane lines.
- The vehicle changes lanes.
- The vehicle is not in D.
- The vehicle sways laterally too fast.
- The vehicle speed is below 33mph, or above 93mph.
- The anti-lock brake system (ABS) and the dynamic stability control system (SCS) are activated.
- Faults exist in the anti-lock brake system (ABS), dynamic stability control system (SCS), electric power steering system (EPS), etc.

IMPORTANT

The lane departure warning system will not provide an alert in the following situations:

- The driver indicates in the direction of the lane line about to be crossed.
- The hazard lamps are activated.
- The driver applies the accelerator rapidly, carries out an emergency manoeuvre or makes a hard brake pedal application.

It is recommended to turn off the lane departure warning system in the following situations:

- Driving in a sports style or manner.
- Driving in bad weather conditions.
- Driving on rough or poor road surfaces.
- Driving through roadworks or construction sites.

Lane Departure Prevention System (LDP)



The lane departure prevention system is an auxiliary system that provides assistance to the driver. It does NOT remove the responsibility of safe driving from the driver. When choosing to use the lane departure prevention system, the driver MUST always pay attention to the surroundings, hold the steering wheel and be prepared to make manoeuvres at any time. Failure to maintain overall control of the vehicle may result in an accident or personal injury.



The lane departure prevention system does not always recognise the lane lines. Sometimes poor road surfaces, certain road structures or objects may be mistaken for lane lines. When such situations occur, the lane departure prevention system must be immediately turned off.

STARTING & DRIVING

The lane departure prevention system uses the front view camera to detect the lane lines ahead of the vehicle. The system will operate when the following detection conditions are met:

- The function is switched ON.
- Vehicle speed is above 37mph.
- Lane line markings are clear.

As long as the system recognises at least one lane line the indicator lamp in the instrument pack will illuminate green. When a wheel is about to cross the lane line, or has already crossed the line, the system will provide assistance to the driver by keeping the vehicle in between the lane lines by applying corrective steering intervention and simultaneously displaying a prompt. The function will automatically exit when the vehicle speed drops below 33mph.

In cases of two or more consecutive interventions within an accumulated interval of 180 seconds and in the absence of detecting any steering input by the driver during the intervention, an acoustic warning is sounded during the second intervention, and any further interventions within the 180 seconds. If there is need for, and starting with

the third intervention, the acoustic alarm warning will continue longer than the previous warning signal. The lane departure prevention function will exit after five interventions in the absence of a steering input by the driver being detected during the interventions.

Lane departure prevention system setting

The operating interface for the lane departure prevention system is located in the infotainment display. Enter the vehicle setting interface to locate the driving assist option, scroll across the page to find the setting interface for the lane assist system:

- 1 Touch the corresponding button in the infotainment display to turn the lane assist system ON/OFF. Select departure assist in the assist mode to switch the lane departure prevention system ON. The system defaults to the last selected state from when the START/STOP Switch was ON/READY.
- 2 Touch the corresponding button in the infotainment display to turn the audible alert ON/OFF. The system defaults to the last selected state from when the START/STOP Switch was ON/READY.

- 3 Touch the corresponding button in the infotainment display to adjust the alert sensitivity. The system defaults to the last selected state from when the START/STOP Switch was ON/READY.
- 4 Touch the corresponding button in the infotainment display to turn the vibration alert ON/OFF. The system defaults to the last selected state from when the START/STOP Switch was ON/READY.

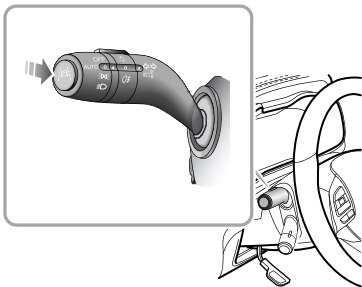

Having turned the lane departure prevention system on in the infotainment display, press the button at the end of the indicator stalk switch (as shown above). The lane departure prevention system will enter the standby or active state. The system defaults to the last selected state from when the START/STOP Switch was ON/READY.

When the lane departure prevention system is in the standby or active state, you can temporarily disable the function by pressing the button at the end of the indicator stalk switch (as shown above). Pressing the button again will resume the function.



When the lane departure prevention function is enabled, the indicator lamp illuminates yellow. When the function is enabled and the vehicle speed is above 37mph, the indicator lamp turns green. When the function is disabled, the system indicator lamp extinguishes. If the lane departure prevention system detects a fault or failure, the indicator lamp will flash yellow for 90s, and then remain on.

STARTING & DRIVING

The lane departure prevention system will be impaired in the following conditions:

- The system detects that the driver has not moved the steering wheel for a preset time period.
- During system intervention the steering wheel is turned in the opposite direction.
- The front view camera is obstructed or it is impossible for the camera to detect the lane line ahead due to weather and environmental factors.
- The lane line is too thin, damaged, or fuzzy.
- The vehicle is driven on the bend with a small curvature radius.
- The width of the road is too narrow or too wide.
- The vehicle is driven on a road section without lane lines.
- The vehicle has just entered a road section with lane lines.
- The vehicle changes lanes.
- The vehicle is not in D.
- The vehicle sways laterally too fast.
- The vehicle speed is below 33mph, or above 93mph.

- The anti-lock brake system (ABS) and the dynamic stability control system (SCS) are activated.
- Faults exist in the anti-lock brake system (ABS), dynamic stability control system (SCS), electric power steering system (EPS), etc.

IMPORTANT

The lane departure prevention system will not operate in the following situations:

- The driver indicates in the direction of the lane line about to be crossed.
- The hazard lamps are activated.
- The driver applies the accelerator rapidly, carries out an emergency manoeuvre or makes a hard brake pedal application.

IMPORTANT

- In cases where the number of lanes increase or lanes merge the driver **MUST** take full control of the vehicle.
- In areas where there are complex traffic conditions such as intersections or road junctions with congestion, the driver **MUST** take full control.

It is recommended to turn off the lane departure prevention system in the following situations:

- Driving in a sports style or manner.
- Driving in bad weather conditions.
- Driving on rough or poor road surfaces.
- Driving through roadworks or construction sites.

Lane Keeping Assist System (LKA)



*The lane keeping assist system is an auxiliary system that provides assistance to the driver. It does **NOT** remove the responsibility of safe driving from the driver. When choosing to use the lane keeping assist system, the driver **MUST** always pay attention to the surroundings, hold the steering wheel and be prepared to make manoeuvres at any time. Failure to maintain overall control of the vehicle may result in an accident or personal injury.*



The lane keeping assist system does not always recognise the lane line. Sometimes poor road surfaces, certain road structures or objects may be mistaken for lane lines. When such situations occur, the lane keeping assist system must be immediately turned off.

The lane keeping assist system uses the front view camera to detect the lane lines ahead of the vehicle. The system

STARTING & DRIVING

will operate when the following detection conditions are met:

- The function is switched ON.
- Vehicle speed is above 37mph.
- Lane line markings are clear.

As long as the system recognises two lane lines on both sides the indicator lamp in the instrument pack will illuminate green. The system will always attempt to maintain the vehicle position in the centre of the lane by using corrective steering interventions. If the vehicle deviates from the lane lines the system will activate the lane departure warning function to alert the driver that the vehicle has deviated from the lane. The driver can take corrective action at any time. The function will automatically exit when the vehicle speed drops below 33mph.

In the absence of a steering input from the driver for some seconds, an acoustic warning is provided, the instrument pack provides a yellow prompt. If the system still fails to see an input from the driver, the acoustic warning becomes continuous and the prompt illuminates red. If the system still fails to detect an input from the driver, it will assume

the driver is not able to keep their hands on the steering wheel and automatically exit the function. Accompanied by the exit, a more urgent acoustic warning is provided for at least 5s or until the driver holds the steering control again.

Lane keeping assist system setting

The operating interface for the lane keeping assist system is located in the infotainment display. Enter the vehicle setting interface to locate the driving assist option, scroll across the page to find the setting interface for the lane assist system:

- 1 Touch the corresponding button in the infotainment display to turn the lane assist system ON/OFF. Select lane keeping in the assist mode to switch the lane keeping assist system ON. The system defaults to the last selected state from when the START/STOP Switch was ON/READY.
- 2 Touch the corresponding button in the infotainment display to turn the audible alert ON/OFF. The system defaults to the last selected state from when the START/STOP Switch was ON/READY.

- 3 Touch the corresponding button in the infotainment display to adjust the alert sensitivity. The system defaults to the last selected state from when the START/STOP Switch was ON/READY.
- 4 Touch the corresponding button in the infotainment display to turn the vibration alert ON/OFF. The system defaults to the last selected state from when the START/STOP Switch was ON/READY.

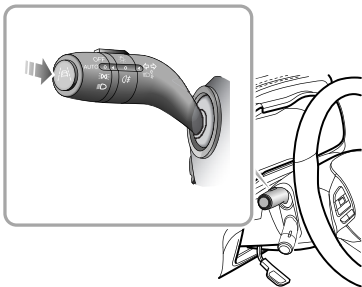

Having turned the lane keeping assist system on in the infotainment display, press the button at the end of the indicator stalk switch (as shown above). The lane keeping assist system will enter the standby or active state. The system defaults to the last selected state from when the START/STOP Switch was ON/READY.

When the lane keeping assist system is in the standby or active state, you can temporarily disable the function by pressing the button at the end of the indicator stalk switch (as shown above). Pressing the button again will resume the function.



When the lane keeping assist function is enabled, the indicator lamp illuminates yellow. When the function is enabled and the vehicle speed is above 37mph, the indicator lamp turns green. When the function is disabled, the system indicator lamp extinguishes. If the lane keeping assist system detects a fault or failure, the indicator lamp will flash yellow for 90s, and then remain on.

STARTING & DRIVING

The lane keeping assist system will be impaired in the following conditions:

- The system detects that the driver has not moved the steering wheel for a preset time period.
- During system intervention the steering wheel is being manipulated by the driver.
- The front view camera is obstructed or it is impossible for the camera to detect the lane line ahead due to weather and environmental factors.
- The lane line is too thin, damaged, or fuzzy.
- The vehicle is driven on the bend with a small curvature radius.
- The width of the road is too narrow or too wide.
- The vehicle is driven on a road section without lane lines.
- The vehicle has just entered a road section with lane lines.
- The vehicle changes lanes.
- The vehicle is not in D.
- The vehicle sways laterally too fast.
- The vehicle speed is below 33mph, or above 93mph.

- The anti-lock brake system (ABS) and the dynamic stability control system (SCS) are activated.
- Faults exist in the anti-lock brake system (ABS), dynamic stability control system (SCS), electric power steering system (EPS), etc.

IMPORTANT

The lane keeping assist system will not operate in the following situations:

- The driver indicates in the direction of the lane line about to be crossed.
- The hazard lamps are activated.
- The driver applies the accelerator rapidly, carries out an emergency manoeuvre or makes a hard brake pedal application.

IMPORTANT

- In cases where the number of lanes increase or lanes merge the driver **MUST** take full control of the vehicle.
- In areas where there are complex traffic conditions such as intersections or road junctions with congestion, the driver **MUST** take full control.

It is recommended to turn off the lane keeping assist system in the following situations:

- Driving in a sports style or manner.
- Driving in bad weather conditions.
- Driving on rough or poor road surfaces.
- Driving through roadworks or construction sites.

MG Pilot System



The assistant technology used in the MG Pilot system cannot replace the driver's judgment on the road and traffic conditions. The system can provide assistance for the driver but cannot replace the driver in driving. When choosing to use the MG Pilot system, due to the limitations of system detection and control, the driver must always be careful. Failure to maintain overall control of the vehicle may result in an accident or personal injury.



The MG Pilot system is a driver assistance function, it is NOT auto pilot. There are many situations where the function is restricted or exits. The driver needs to hold the steering wheel at all times and correct or take over the steering wheel control if necessary.

STARTING & DRIVING

The MG Pilot system needs to be used in conjunction with the adaptive cruise control system. The MG Pilot system works on the basis of the adaptive cruise control system. If the lane lines ahead on both sides are clear, the system can assist the vehicle in driving within the lane lines. When driving at a speed lower than 37mph, if there is a vehicle ahead and the lane lines ahead on both sides aren't clear, the system also can assist the vehicle in following the track of the vehicle ahead.

Note: *The driver should adjust the vehicle speed and the following distance according to the road visibility, weather and road conditions. The MG Pilot system does not respond to pedestrians, animals, stationary vehicles and vehicles that drive across the lane or oncoming vehicles in the same lane. If the MG Pilot system cannot reduce the vehicle speed adequately, the driver MUST apply the brakes. In congested conditions, should another vehicle cut into the lane being used by the vehicle under MG Pilot control, the system may not detect the vehicle in adequate time to make a braking manoeuvre. In this case the brakes should be applied by the driver.*

In the absence of a steering input from the driver for some seconds, an acoustic warning is provided, the instrument pack provides a yellow prompt. If the system still fails to see an input from the driver, the acoustic warning becomes continuous and the prompt illuminates red. If the system still fails to detect an input from the driver, it will assume the driver is not able to keep their hands on the steering wheel and automatically exit the function. Accompanied by the exit, a more urgent acoustic warning is provided for at least 5s or until the driver holds the steering control again.

Note: *When the driver uses this function to follow the track of the vehicle in front, the driver MUST pay attention to the surrounding environment. Overall responsibility for direction and braking of the car remains with the driver.*

MG Pilot system setting

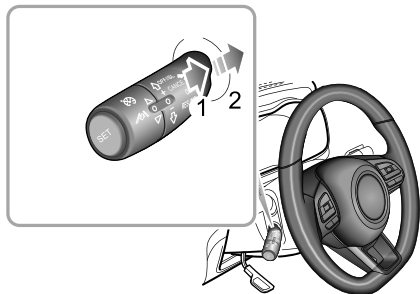

The operating interface for the MG Pilot system is located in the infotainment display. Enter the vehicle setting interface to locate the driving assist option, scroll across the page to find the setting interface for the MG Pilot system. The driver may select to turn it on/off. To use the MG Pilot system, the adaptive cruise control system must be turned on at the same time. When the function

is turned off, the message centre in the instrument pack will display the corresponding prompt.

Turn the adaptive cruise control level to “RESUME” twice will switch the MG Pilot system from standby to active state.



When the MG Pilot function is enabled, the indicator lamp illuminates yellow. When the function is active, the indicator lamp illuminates green. When the function is disabled, the system indicator lamp extinguishes. If the MG Pilot system detects a fault or failure, the indicator lamp will flash yellow for 90s, and then remain on.

Technical requirements for using MG Pilot system:

- The adaptive cruise control system must be activated.
- The MG Pilot system must be switched on via the corresponding button in the infotainment system.
- If the vehicle speed is below 37mph, the system must be able to detect lane lines on both sides of the vehicle or a target vehicle directly ahead.

STARTING & DRIVING

- If the vehicle speed is greater than 37mph, the system must be able to detect lane lines on both sides of the vehicle.
- The vehicle is in D.

The MG Pilot system will be impaired in the following conditions:

- The system detects that the driver has not moved the steering wheel for a preset time period.
- During system intervention the steering wheel is being manipulated by the driver.
- The technical requirements for MG Pilot system are not met.
- The front view camera is obstructed or it is impossible for the camera to detect the lane line ahead due to weather and environmental factors.
- The lane line is too thin, damaged, or fuzzy.
- The vehicle is driven on the bend with a small curvature radius.
- The width of the road is too narrow or too wide.
- The vehicle is driven on a road section without lane lines.

- The vehicle has just entered a road section with lane lines.
- The vehicle changes lanes.
- The vehicle is not in D.
- The vehicle sways laterally too fast.
- The vehicle speed is below 33mph, or above 111mph.
- The anti-lock brake system (ABS) and the dynamic stability control system (SCS) are activated.
- Faults exist in the anti-lock brake system (ABS), dynamic stability control system (SCS), electric power steering system (EPS), etc.

It is recommended to turn off the MG Pilot system in the following situations:

- Driving in a sports style or manner.
- Driving in bad weather conditions.
- Driving on rough or poor road surfaces.
- Driving through roadworks or construction sites.
- Driving through complicated road sections (such as urban sites and intersections).
- Driving on steep or excessively winding roads in low visibility.

- Driving on grass tracks or unpaved roads.

IMPORTANT

The MG Pilot system will not operate in the following situations:

- The driver indicates.
- The hazard lamps are activated.
- The driver applies the accelerator rapidly, carries out an emergency manoeuvre or makes a hard brake pedal application.

IMPORTANT

- In cases where the number of lanes increase or lanes merge the driver **MUST** take full control of the vehicle.
- In areas where there are complex traffic conditions such as intersections or road junctions with congestion, the driver **MUST** take full control.
- The driver **MUST** be aware of the surroundings and be able to assume full control of the vehicle when using the MG Pilot function to track the car in front should the need arise.

STARTING & DRIVING

Forward Collision Warning System (FCW)



The driver should pay full attention and drive carefully even if the vehicle is equipped with the forward collision warning system.

The forward collision warning system detects other vehicles and pedestrians ahead using the forward detection radar and front view camera. When the speed is above 18mph and the vehicle is approaching the vehicle or pedestrian ahead rapidly, the system will prompt the driver to slow down in time and keep a relatively safe distance from the vehicle or pedestrian ahead by emitting an audible alert and displaying a prompt in the information message centre in the instrument pack.

Note: *When the vehicle speed is between 18 and 52mph, stationary targets can be detected. When the vehicle speed is between 18 and 93mph, moving targets can be detected. When the vehicle speed is between 18 and 39mph, pedestrians can be detected.*

Forward collision warning system setting

The operating interface for the forward collision warning system is located in the infotainment display. Enter the vehicle setting interface to locate the driving assist option, scroll across the page to find the setting interface for the forward collision system.

- 1 Touch the corresponding button in the infotainment display to switch the forward collision system on/off. Select alert in the assist mode to activate the forward collision warning system. When the START/STOP Switch is ON/READY, the switch defaults to ON. When the driver actively selects to turn off the function, the prompt message will be displayed in the information message centre in the instrument pack, and the confirmation message pop up in the infotainment display.
- 2 Touch the corresponding button in the infotainment system to adjust the alert sensitivity. The system defaults to the last selected state from when the START/STOP Switch was ON/READY.



The lamp illuminates yellow when the forward collision warning system is turned off or detects a fault or failure.

The forward collision warning system will be impaired in the following conditions:

- The front view camera is obstructed or its performance is affected.
- The vehicle is driving on a bend with a small curve radius.
- The vehicle ahead is of a non standard type, or only the side can be detected.
- The vehicle ahead is too large or close making it impossible to make out the complete outline.
- The vehicle is on an excessive gradient or slope.
- The vehicle is in R.
- The vehicle is accelerating or braking excessively hard.
- There are animals, signposts, guardrails, buildings or similar non motorised objects ahead.

Automatic Emergency Braking System (AEB) and Automatic Emergency Braking System for Pedestrians (AEBP)



*The driver remains responsible for the safety of the entire driving process, even if the vehicle is equipped with automatic emergency braking system and automatic emergency braking system for pedestrians. The driver **MUST** pay full attention and drive carefully. As driver assist systems, the automatic emergency braking system and automatic emergency braking system for pedestrians cannot prevent accidents or avoid collisions in all situations. The driver **MUST** always remain in control to avoid accidents or emergency situations.*

STARTING & DRIVING



*Emergency braking whilst under the control of the automatic emergency braking system and automatic emergency braking system for pedestrians may cause injuries to the passengers. Therefore, drive carefully and all passengers **MUST** wear seat belts at all times.*



Ensure the automatic emergency braking system, automatic emergency braking system for pedestrians or vehicle power system is switched off when being towed. If the automatic emergency braking system and automatic emergency braking system for pedestrians is enabled when the vehicle is being towed, adverse effects may affect the safety of your vehicle, the towing vehicle and the people around.



To avoid the occurrence of accidents, never specially test the functions of the automatic emergency braking system and automatic emergency braking system for pedestrians.

When the switch for the automatic emergency braking system in the infotainment display is ON, the system will detect and monitor the vehicle ahead in the same lane using the forward detection radar and front view camera. When the system detects that there is a risk of collision between the vehicle and the vehicle ahead, the brake system will automatically intervene to decelerate the vehicle, so as to avoid collision accidents or mitigate damage from collision accidents. If the vehicle is braked and stopped under AEB or AEBP control, it will remain stationary for about 2s. Then the control of the vehicle will be handed over to the driver.

When the switch for the automatic emergency braking system for pedestrians in the infotainment display is ON, the system will detect and monitor the pedestrians ahead in the same lane using the forward detection radar and front view camera. When the system detects that there is a risk

of collision between the vehicle and the pedestrian ahead, the brake system will automatically intervene to decelerate the vehicle, so as to avoid collision accidents or mitigate damage from collision accidents. If the vehicle is braked and stopped under AEB or AEBP control, it will keep stationary for approx. 2s, then the control of the vehicle will be handed over to the driver.

Note: *When the vehicle speed is between 2 and 52mph, stationary targets can be detected. When the vehicle speed is between 2 and 93mph, moving targets can be detected. When the vehicle speed is between 2 and 39mph, pedestrians can be detected.*

IMPORTANT

- For stationary targets, collisions cannot be completely avoided when the vehicle speed is greater than 27mph.
- For moving targets, collisions cannot be completely avoided when the relative speed is greater than 27mph.

The automatic emergency braking system and automatic emergency braking system for pedestrians will only be activated if the following conditions are met:

- The dynamic stability control system (SCS) and traction control system (TCS) are fault-free and ON.
- The vehicle is in D or N.
- The airbags are not deployed.

Note: *In some cases, the driver may not have anticipated any braking intervention and does not want to apply the brakes whilst the automatic emergency braking system and automatic emergency braking system for pedestrians are braking heavily, the driver can temporarily cancel this operation by heavily pressing the accelerator pedal after ensuring that it is safe to do so.*

Automatic emergency braking system and automatic emergency braking system for pedestrians setting

The operating interface for the AEB/AEBP system is located in the infotainment display. Enter the vehicle

STARTING & DRIVING

setting interface to locate the driving assist option, scroll across the page to find the setting interface for the forward collision system:

- 1 Touch the corresponding button in the infotainment system to switch the forward collision system on/off. Select emergency braking in the assist mode to activate the automatic emergency braking system. When the START/STOP Switch is ON/READY, the switch of the system defaults to ON. When the driver actively selects to turn off the function, a prompt message will be displayed in the information message centre in the instrument pack and a pop up message will appear in the infotainment display.
- 2 Touch the corresponding button in the infotainment system to switch the automatic emergency braking system for pedestrians on/off. When the START/STOP Switch is ON/READY, the switch defaults to ON. When the driver actively selects to turn off the function, a prompt message will be displayed in the information message centre in the instrument pack and a pop up message will appear in the infotainment display.

Note: DO NOT operate any infotainment switches whilst driving. If you wish to make any settings changes please pull over when it is safe and legal to do so.



The indicator lamp illuminates yellow when the automatic emergency braking system is turned off or detects a fault or failure.



The indicator lamp illuminates yellow when the automatic emergency braking system for pedestrians is turned off or detects a fault or failure.

The operation of the automatic emergency braking system and automatic emergency braking system for pedestrians may be impaired in the following situations:

- The detection performance of forward detection radar or front view camera is impaired.
- The contour of the vehicle ahead is unclear, for example: water sprayed by the wheels of the front

and surrounding vehicles in heavy rain/spray or snow conditions.

- When driving on special road conditions, for example, on a curve or a slope, on the section coming on/off a bridge, a vehicle ahead, an oncoming vehicle, a vehicle crossing the intersection, a vehicle making a turn, the side of a vehicle or a vehicle jumping the queue rapidly in a short distance is detected.
- There are vehicles running in the opposite direction in the same lane, or the vehicle itself runs in opposite direction.
- The vehicle ahead does not have or has obscured tail lamps when driving at night or in a tunnel; the tail lamps of the vehicle ahead are all LED strip lights or other homemade coloured lamps; inconsistent or flickering street lights when driving at night.
- The vehicle ahead is an ultra-large vehicle or a trailer, which is too big to be recognised by the system (such as a tractor, a trailer, a towing vehicle)
- The vehicle ahead does not follow the rules of driving and parking; the vehicle ahead is driving on the lane lines;

the vehicle ahead is not in the same lane as your vehicle or the view of vehicle ahead is partially obscured.

- The pedestrian is not directly in front of the vehicle; the pedestrian is not fully visible; the pedestrian is not standing upright; there are a crowd of pedestrians; the pedestrian is over-shadowed; the pedestrian is in the dark or it is a child under a certain height, etc.

Note: The two systems function only when a vehicle or pedestrian is detected in the same lane ahead. The system cannot recognise any special-shaped ground obstacles (such as roadblocks, isolation piles, isolation strips, large stones and other scattered objects) and animals. The system may not recognise bicycles, motorbikes, small wheeled objects (such as suitcases, shopping carts or wheelchairs), some means of unusual transportation (such as the horse and cart, carriages etc.) and vehicles with higher chassis.

STARTING & DRIVING

Load Carrying



DO NOT exceed the **gross vehicle weight** or the **permitted front and rear axle loads**. **Failure may result in vehicle damage or serious injury.**

Load Space



Ensure that the rear seat backrests are securely latched in the upright position when loads are carried in the load space behind the seats.



If the boot lid (or tailgate) can not be closed due to the type of cargo loaded, be sure to close all windows during driving, select the face distribution mode of the air condition, and set the blower to maximum speed, so as to decrease exhaust fumes entering the vehicle.

When luggage is carried in the boot, always ensure heavy items are placed as low and as far forward as possible, so

as to avoid cargo shift in the event of an accident or sudden stop.

Drive carefully and avoid emergency braking or maneuvers when large or heavy items are carried.

Driving with the boot lid (or tailgate) open is very dangerous. If the load being carried requires the boot lid (or tailgate) to be open, please ensure the cargo and the boot lid (or tailgate) are suitably secured and every measure is taken to prevent exhaust fumes entering the vehicle.

IMPORTANT

Traffic regulations must be observed when loading cargo, if the cargo extrudes the loadspace, appropriate warning measures must be taken to warn other road users.

Internal Loading



DO NOT carry unsecured equipment, tools or luggage that could move, causing personal injury in the event of an accident, emergency braking or hard acceleration.



DO NOT create an obstruction that prevents the driver or passenger maintaining the correct sitting posture or obscures their vision.

Folding the rear seats can increase luggage space, refer to "Rear Seat" in "Seats and Restraints" chapter.

When cargo is loaded in the vehicle, place it at a position as low as possible and ensure that it is tightly secured, so as to avoid personal injury caused by cargo movement when traffic accidents or emergency braking occurs. If the cargo has to be put on a seat, no one is allowed to sit on that seat.

General Towing Safety

Your vehicle can tow a trailer if you carefully observe load limits, use approved equipment, and follow the towing guidelines. Always check load limits before towing.

Towing loads in excess of the maximum towing weight can seriously affect vehicle handling and performance, and could damage your vehicles engine and drive-train.

Note: Exceeding any load limits advised by MG Motor UK Ltd is dangerous. Consult the recommended load limits and loading prior to any journey.

Check the loading of your vehicle and trailer carefully before starting to drive.

Trailer hitch load should never exceed the limit advised by MG Motor UK Ltd.

Note: Excessive towing loads reduce front tyre traction and steering control, too little trailer nose load can make the trailer unstable and cause it to sway.

Tow bars: Only genuine MG approved tow bars should be fitted to your vehicle. Only use the attachment method specified by the vehicle manufacturer for securing the

STARTING & DRIVING

towing hitch. Contact your authorised MG dealer for more information.

Safety chains: Safety chains must be used as a precautionary measure should the trailer become unintentionally unhitched. Make sure the safety chain is securely attached to both the trailer and the vehicle prior to departure.

Altitude: Your engine delivers less power at higher altitude. If you tow a trailer in a mountainous area you should reduce the combined vehicle and trailer weight by 10% for every 1000m of elevation.

Gradients: Where possible, when towing, you should plan your journey to avoid steep gradients. The advised brake towing mass stated assumes a maximum gradient capability of 12%. Where possible it is recommended you drive on gradients less than 12%. Follow the trailer associations recommendations for suitable roads.

Running in period: Avoid towing a trailer during your vehicles first 1000 km or 625 miles.

Stop/Start function: Manually switch the Automated Stop/Start function OFF when towing. The trailer weight

can affect your vehicles braking efficiency if Automated Stop/Start is activated on a hill while towing a trailer.

Emergency Information

252 Hazard Warning Devices

254 eCall - SOS Emergency Assistance

257 Emergency Starting

260 Vehicle Recovery

*263 Tyre Repair and Wheel
Replacement*

270 Fuse Replacement

283 Bulb Replacement

EMERGENCY INFORMATION

Hazard Warning Devices

Hazard Warning Lamps

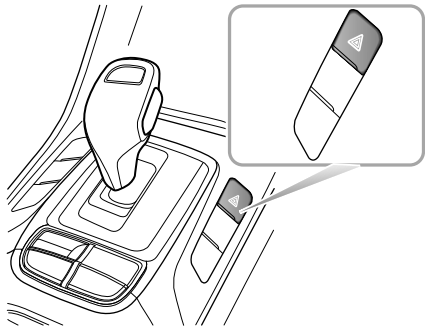

Note: Before you stop or slow the vehicle in an emergency, always press the hazard warning switch. All turn signal lamps and direction indicators will flash together to warn other road users when your vehicle is

causing an obstruction or is in a hazardous situation. Remember to switch them off before driving away.

Warning Triangle

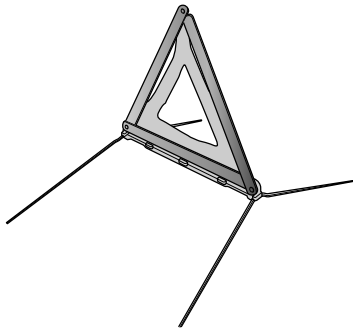

The warning triangle supplied with your vehicle is stowed in the loadspace.

If you have to stop your vehicle on the road in an emergency, you must place a warning triangle

EMERGENCY INFORMATION

approximately 50 — 150 metres behind the vehicle, if possible, to warn other road users of your position.

EMERGENCY INFORMATION

eCall - SOS Emergency Assistance

In an accident, your vehicle's eCall – SOS Emergency Assistance can either be triggered manually or in severe cases automatically upon detection by vehicle's sensors. The eCall service is a public service of general interest and is accessible free of charge. The emergency call centre will establish verbal communication with the vehicle occupants in order to understand the extent of the emergency and the level of assistance required. If verbal communication is not achievable an attempt will be made to send the following vehicle information message to the emergency call centre. The appropriate emergency services will be deployed to the vehicle's current location if known.

- Current time, location and direction of travel
- Vehicle type
- Vehicle identification number (VIN)
- Whether the call was automatically or manually initiated
- Vehicle category

This system will ensure that your personal data is securely protected. It is designed to ensure that it is not traceable and other external systems are not available . When

the eCall triggers, the system will only transmit the data information to the relevant public safety answering points designated by the respective public authorities of the country on which territory they are located, which will receive and process your emergency call request. The system will retain data locally within 13 hours of triggering.

You have the right to access the data information stored in this system, and to request the rectification, erasure or blocking of data information that does not meet the requirements of the regulations. When you think your personal data is infringed, you have the right to complain to the competent data protection authority.

For manual activation, press and release the SOS button in the overhead console for 1 second to activate an emergency services call. A single beep will be heard when the eCall is triggered and a message will be displayed on the vehicle's message centre and entertainment player. The entertainment player will be muted whilst the emergency services call is active. Manually triggered emergency services calls may be cancelled by pressing and releasing the SOS button again within 5 seconds of the initial press, two beeps will be heard confirming that the emergency

EMERGENCY INFORMATION

services call has been cancelled and the messages will be removed.

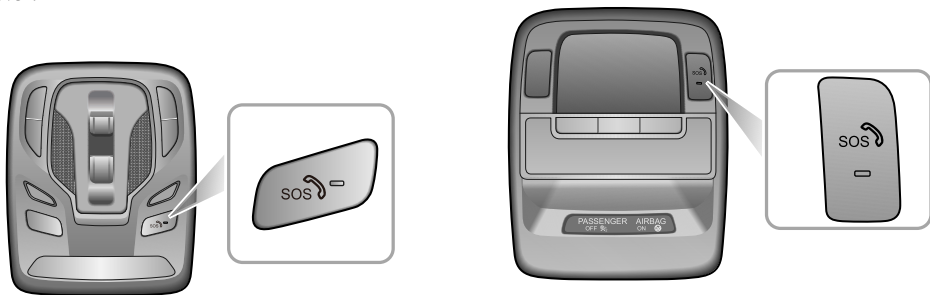

The emergency services call (eCall) system will perform a self-test when the ignition is turned ON. During a Self-Test the emergency services call (eCall) LED status indicator on the SOS button will flash quickly until completion. The LED status indicator will be illuminated solid if no system faults are present. The LED status indicator will be extinguished or flash slowly if a fault is detected. Faults detected during the self-test will be displayed on the vehicle's message centre.

EMERGENCY INFORMATION

Note: *The operation of eCall - SOS Emergency Assistance relies on cellular coverage and may be affected by signal outages or low signal strength.*

Note: *The automatic emergency services call (eCall) function may be disabled by a local MG Authorised Repairer upon request.*

Note: *It is strongly recommended the eCall function is not disabled, any action requested by the owner must be accompanied by a signed request.*

Emergency Starting

Using Booster Cables

! NEVER attempt to start or power the vehicle by pushing or towing.

! Make sure that both batteries are of the same rated voltage (12 volts), and that the booster cables are approved for use with 12 volt car batteries.

! Ensure sparks and naked flames are kept well away from the front compartment.

Using booster cables (jump leads) from a donor battery, or a battery fitted to a donor vehicle, is the only approved method of powering a car with a flat battery.

If the battery from a donor vehicle is to be used, make sure that the vehicles are parked so that the two batteries are adjacent to one another and that both the vehicles do not touch.

Starting the Car



Ensure that each booster cable connection is securely made. There must be no risk of the clips accidentally slipping from the battery terminals (as a result of engine vibration, for example), this could cause sparking, which could lead to fire or explosion.

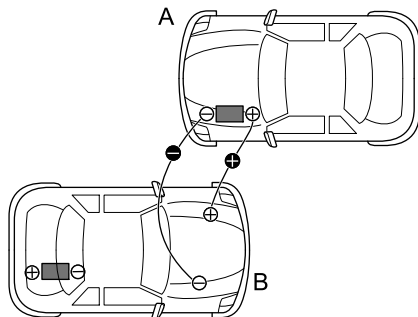

EMERGENCY INFORMATION



Where it is possible to open the tailgate of the disabled vehicle (B), please always give priority to the positive terminal as the positive connecting point. If the tailgate cannot be opened, please open the front compartment fuse-box. The terminal shown in figure below can be used as the positive connecting point.

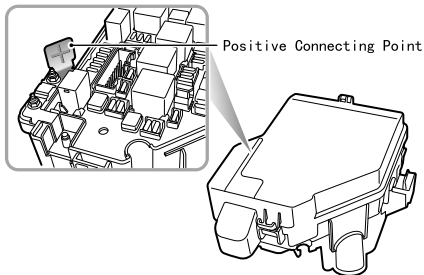

Ensure the START/STOP Switch is turned off and switch off ALL electrical equipment of BOTH vehicles, then follow the instructions below:

- 1 Connect the RED booster cable between the positive (+) terminals of both batteries. Connect the BLACK booster cable from the negative (-) terminal of the donor battery (A) to a good earth point (an engine mounting or other unpainted surface, for example), as far away from the battery as possible and well away from fuel and brake lines on the disabled vehicle (B).
- 2 Check that the cables are clear of moving parts of both engines, then start the engine of the donor vehicle and allow it to idle for a few minutes.
- 3 Now switch the vehicle power system of the vehicle with the discharged battery to READY, and/or start the engine (DO NOT crank the engine for more than 10 seconds). If the disabled vehicle will not switch to READY it may need to be repaired. Please contact an MG Authorised Repairer.
- 4 After both the vehicles have normally started/powerd, leave the vehicles connected in this

state for more than 2 minutes before shutting down the engine of the donor vehicle and disconnecting the booster cables.

IMPORTANT

NEVER turn on any electrical equipment on the started vehicle before removing the booster cables.

- 5 Disconnecting the booster cables must be an exact reversal of the procedure used to connect them, i.e. disconnect the BLACK cable from the earth point on the disabled vehicle FIRST.

Note: *It is recommended to ensure that the disabled vehicle remains powered or runs for more than 1 hour after it is started, in order to recover the battery power.*

EMERGENCY INFORMATION

Vehicle Recovery

Towing for Recovery

Towing Eye



DO NOT use a tow rope that is twisted - or the towing hook may be unscrewed.

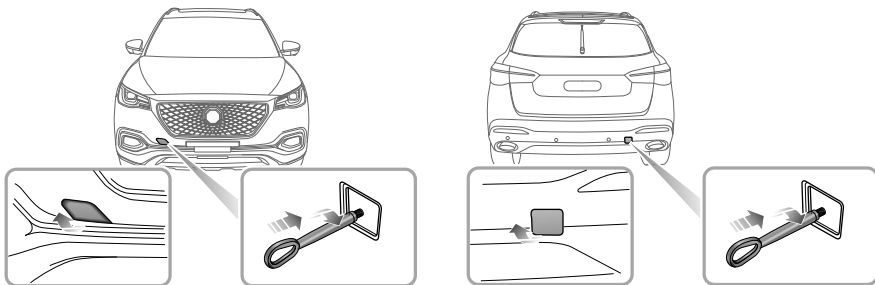

EMERGENCY INFORMATION

Your car is equipped with 2 towing eyes (located at the front and the rear of the vehicle), which are used for fitting the towing hook in the tool kit. The tool kit is placed beneath the loadspace floor. To fit the towing hook, remove the small cover set into the bumper, then screw the towing hook via the small hole into the threaded hole in the bumper beam (see illustration). Ensure the towing hook is fully tightened!

Note: *The small cover removed may be secured to the bumper by a plastic cord.*

Both towing points are intended for using by qualified recovery specialists to assist in the recovery of your vehicle when a breakdown or accident occurs. They are not designed for towing other vehicles, and must NEVER be used to tow a trailer or caravan. The vehicle can be towed using a tow rope but a towing bar is recommended.

Towing



When towing, DO NOT accelerate or brake suddenly, this can cause accidents.



DO NOT tow the vehicle with the driven front wheels in contact with the road surface.



When pushing or towing the vehicle onto the transporter, the driver's side seat belt should be inserted into the lock and maintained in the inserted state in order to release the EPB. The speed must remain below 3mph and be completed within 3 minutes.

Suspended Towing



DO NOT let the high voltage battery pack touch the ground.

If your vehicle needs to be towed, most qualified recovery specialists will use wheel lift equipment to suspend the vehicle. The driven wheels MUST be suspended above the ground, this is to avoid any damage to the drive components and possible inadvertent powering of the vehicle. Ensure the parking brake is released, the hazard

EMERGENCY INFORMATION

warning lamps are activated and no passengers are left in the vehicle.

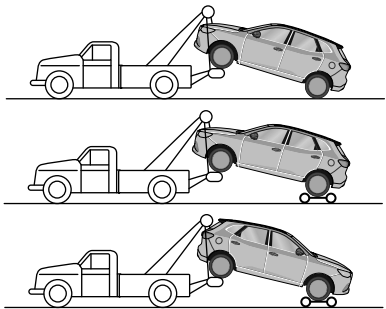

Transporter

If your car is to be transported on the back of a trailer or transporter, it must be secured as illustrated:

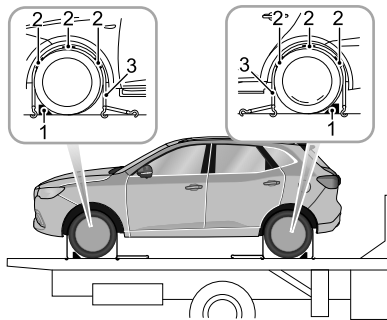

- 1 Apply the parking brake, place the shift lever in Park (P).
- 2 Place the wheel chock (1) as shown in the figure, then place the anti slip rubber pad (2) around the circumference of the tyre.
- 3 Fit the lashing straps (3) around the wheels and secure to the trailer. Tighten the straps until your vehicle is securely held.

Tyre Repair and Wheel Replacement

Tool Identification

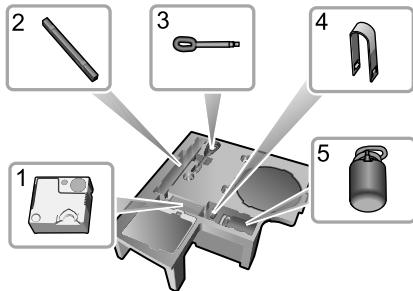

- 1 Electric Air Pump
- 2 Warning Triangle
- 3 Towing Hook
- 4 Wheel Bolt Cap Removal Tool
- 5 Repair Fluid Reservoir

Tyre Repair

- 1 Remove the label at the bottom of the repair fluid reservoir and attach it to the steering wheel to remind the driver not to exceed 50 mph.

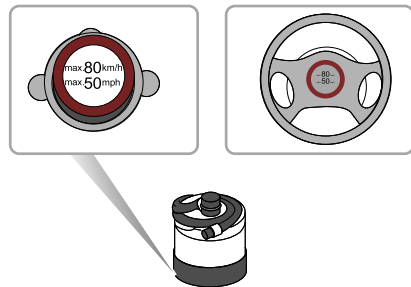

- 2 Connect the air hose of the electric air pump to the repair fluid reservoir, fit the tyre sealant bottle (upright) into the slot on the compressor. Remove the valve dust cap of the flat tyre, and connect the filler hose from the tyre sealant bottle to the tyre

EMERGENCY INFORMATION

valve. Ensure that the power switch of the electric air compressor is switched off (i.e., press “O”), then insert the plug from the compressor into the centre console power socket, and turn the START/STOP Switch to ON/READY.



Note: To avoid battery discharge, it is recommended to keep the vehicle in P and READY mode.

- 3 Switch on the switch of the electric compressor (i.e., press “-”), to start pumping sealant into the tyre. The tyre sealant bottle will become empty after approximately 30 seconds. The tyre should reach the specified pressure within 5 or 10 minutes.

Note: The pressure gauge may briefly reach 6 bar (87 psi), then the pressure begins to drop to normal.

- 4 When the required pressure is reached, switch off the power switch of the electric compressor (i.e., press “O”).

Note: If the required pressure cannot be reached within 10 minutes, please disconnect the compressor, drive the vehicle 10 metres (33 feet) approx forward or backward to allow the sealant to spread within the tyre. If the required pressure can still not be reached, the tyre is severely damaged and you should seek assistance from the MG Authorised Repairer.

Note: *Consecutive operation of Electric air compressor for more than 10 minutes may result in damage to the compressor.*

Note: *Under no circumstances should you continue your journey with a deflated tyre. Driving a vehicle with a deflated tyre is extremely dangerous.*

- 5 Remove the tyre sealant bottle from the slot in the compressor, disconnect the hose from the tyre valve, remove the compressor plug from the centre console power socket, return the tyre repair kit to its stowage tray.
- 6 After successfully adding sealant to the tyre, drive immediately for a short time (around one minute) this will allow the sealant to distribute evenly inside the tyre. Continue driving and do not exceed 50 mph. After a further 10 minutes, find a safe place to stop and recheck the tyre pressure.

Please take different measures based on the tyre pressure measured:

- If the tyre pressure has dropped to less than 0.8 bar (11.6 psi), do not continue driving, seek assistance instead.
- If the tyre pressure is between 0.8 bar (11.6 psi) and specified pressure, connect the hose of electric air pump to the tyre valve, and connect the plug of the electric air pump to the power socket, then switch on the electric air pump to inflate the tyre until it reaches the specified pressure. Repeat the operations of step 6 after driving a maximum distance of 3 miles.

EMERGENCY INFORMATION

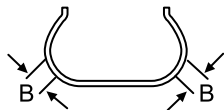
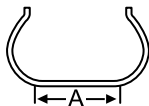

- If the tyre pressure has not dropped, you may continue driving, but the vehicle speed must not exceed 50 mph, and the driving mileage must not exceed 125 miles.

Note: *DO NOT remove foreign objects (eg. screws,nails) from the tyre. The tyre repair system must only be used when the foreign object is in the tread pattern (A), DO NOT attempt a repair when the damage is in the sidewall of the tyre (B).*

EMERGENCY INFORMATION

Changing a Wheel *

If you need to change the wheel during the journey, choose a safe place to stop away from the main road if possible. Always ask your passengers to get out of the car and wait in a safe area away from other traffic.

Switch on hazard warning lamps. If available, position a warning triangle about 50 to 150 metres behind your vehicle to warn approaching traffic.

Before changing a wheel, ensure the front wheels are in the straight ahead position. Apply the parking brake and place the gear shift lever of transmission in N position.

Observe the following precautions:

- Ensure the jack is positioned on firm, level ground.
- If the vehicle must be parked on the hill, place chocks in front of and behind other 3 wheels to prevent the vehicle moving.

Positioning the Jack



NEVER work beneath the car with the jack as the only means of support. The jack is designed for wheel changing only!



NEVER jack the car using any jacking points other than the jacking points. Serious damage to the car could result.

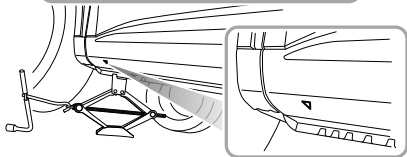
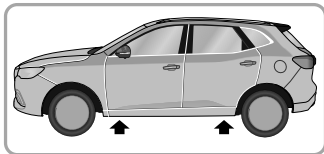

Avoid accidental contact with any underbody parts, especially hot exhaust system and high voltage components.

Position the jack on firm level ground under the jacking point nearest the wheel to be removed. Note that the

EMERGENCY INFORMATION

domed head of the jack must fit into the corresponding recess in the sill plate (There is a triangle indicator in the area shown by the arrowhead. See the illustration above).

Turning the jack screw by hand, adjust the jack until the jack head fits snugly onto the sill in the correct area. Ensure that the base of the jack is in full contact with the level ground.

Fitting the Spare Wheel



Regularly check the spare wheel tyre pressure, it may not be used for long periods of time. After fitment, at the first opportunity check and adjust the tyre pressure.



The wheel bolts must be tightened to the specified torque after changing a wheel (120 ~ 130 Nm).

- 1 Before raising the car, use the special tool supplied with the vehicle to remove each wheel bolt cap. Use the wheel bolt spanner to slacken each bolt half a turn anti-clockwise.

- 2 Turn the handle in a clockwise direction until the tyre is clear of the ground.
- 3 Remove the wheel bolts and place them in the tool tray to prevent them from being lost. Make sure the vehicle is steady and there is no risk of slip or movement before removing wheel bolts.
- 4 Remove the road wheel.

Note: Avoid placing wheels face down on the ground - the surface may be scratched.

- 5 Fit the spare wheel and tighten the wheel bolts with wheel bolt spanner until the wheel is seated firmly against the hub.
- 6 Lower the car and remove the jack, then FULLY tighten the wheel bolts in a diagonal sequence.
- 7 Finally, return the tools to the toolbox, put the toolbox into the well of the boot floor; tighten the spare wheel retaining nuts, and put the replaced wheel above the toolbox in the well in the load space floor (face down). Lower the boot floor, and put the boot storage box on the boot floor.

EMERGENCY INFORMATION

Note: *DO NOT stand on the handle of the wheel bolt spanner or use extension tube on the handle of the spanner.*

Note: *When replacing the wheel, please fully tighten the bolts in the diagonal sequence twice.*

Note: *Consult your MG Authorised Repairer or tyre specialist for a replacement tyre, as soon as possible.*

Spacesaver Spare Wheel



Only one spacesaver spare wheel can be used at any one time, otherwise the operational performance and brake performance may be reduced, thereby leading to accident or injury to yourself and others.



When driving on icy or slippery surfaces it is advised to fit the spacesaver wheel to the rear of the vehicle to maintain adequate stability. This may mean swapping a front wheel with a rear wheel.



Snow chains can not be used on the spacesaver spare wheel, this can cause damage to the car and snow chain.

When the spacesaver spare wheel is fitted, the vehicle speed should not exceed 50 mph. Please have the full-scale tyre repaired and replace the spare wheel as soon as possible. This will extend the life span of the spare wheel for other emergencies.

Note: *DO NOT use an automatic car wash when the spacesaver wheel is fitted, the guide rails of the car wash may conflict with the wheel/tyre and cause damage.*

EMERGENCY INFORMATION

Fuse Replacement

Fuse

Fuses are simple circuit breakers which protect the car's electrical equipment by preventing the electrical circuits from being overloaded. A blown fuse may be indicated when the item of electrical equipment it protect stops working.

If you suspect a fuse has failed it can be checked by removing it from the fuse box and looking for a break in the wire inside the fuse.

It is recommended to have spare fuses in the vehicle, which can be obtained from a local MG Authorised Repairer.

Comparison Before and After the Fuse is Blown

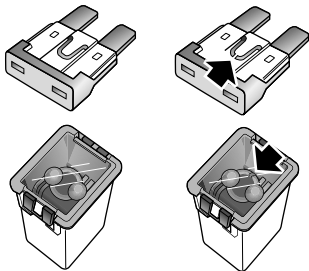

IMPORTANT

- NEVER attempt to repair a blown fuse. ALWAYS replace a fuse with one of the same rating, otherwise the fire may be caused due to electrical system damage or circuit overload.
- If a replaced fuse fails immediately, please contact an MG Authorised Repairer as soon as possible.

Fuse Box

The vehicle is equipped with 3 fuse boxes:

- Luggage compartment fuse box (under the cover plate of luggage compartment Fuse Box)
- Passenger compartment fuse box (behind the right dashboard panel cover)
- Front compartment fuse box (front left of the front compartment)

- 1 Luggage Compartment Fuse Box
- 2 Front Compartment Fuse Box
- 3 Passenger Compartment Fuse Box

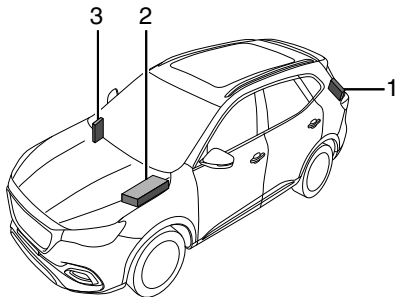

EMERGENCY INFORMATION

Luggage Compartment Fuse Box

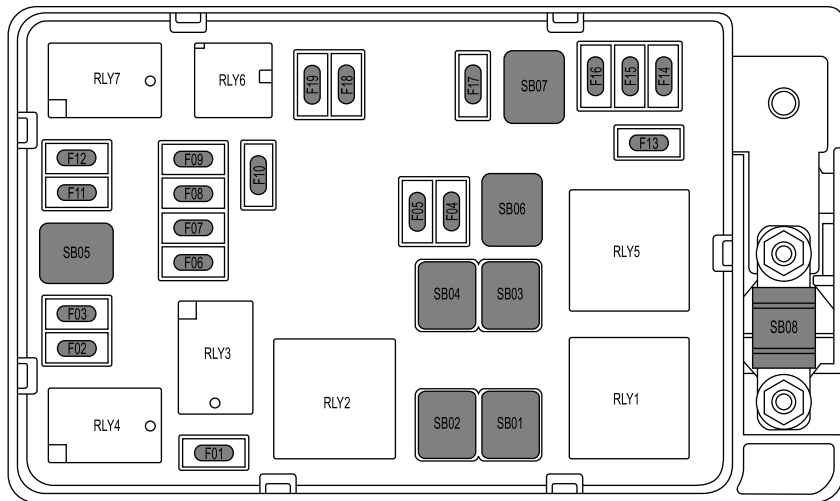

Check or Replace a Fuse

- 1 Turn off the START/STOP Switch and all electrical appliances, and disconnect the battery cable.
- 2 Move the luggage compartment carpet assembly, and open the cover plate of the luggage compartment fuse box marked with Fuse Box.
- 3 Loosen the two clips at the front and the rear of the fuse box, and open the cover plate of the luggage compartment fuse box to access the fuse.
- 4 Hold the fuse head with the fuse extraction tool, pull and remove the fuse, and check if the fuse is blown.
- 5 If a fuse is blown, replace it with another fuse of the same ampere value.

Fuse Specification

Code	Specs	Function
F01	20A	Super Lock Relay
F02	-	-
F03	20A	ESS Coolant Pump Relay

Code	Specs	Function
F04-F07	-	-
F08	15A	Towing Kit Connector Socket
F09	5A	Electrical Battery Sensor
F10	15A	Rear Wiper Relay
F11-F12	-	-
F13	5A	Pedestrian Alert Control Module
F14	-	-
F15	10A	Chassis Management Module
F16	-	-
F17	20A	Energy Storage System , On-Board Charger
F18	-	-

EMERGENCY INFORMATION

Code	Specs	Function
F19	15A	Fuel Pump Relay
SB01	30A	Positive Temperature Coefficient
SB02	30A	Positive Temperature Coefficient
SB03–SB04	-	-
SB05	30A	Power Liftgate Control Module
SB06	30A	Positive Temperature Coefficient
SB07	-	-
SB08	200A	Battery Power

Passenger Compartment Fuse Box

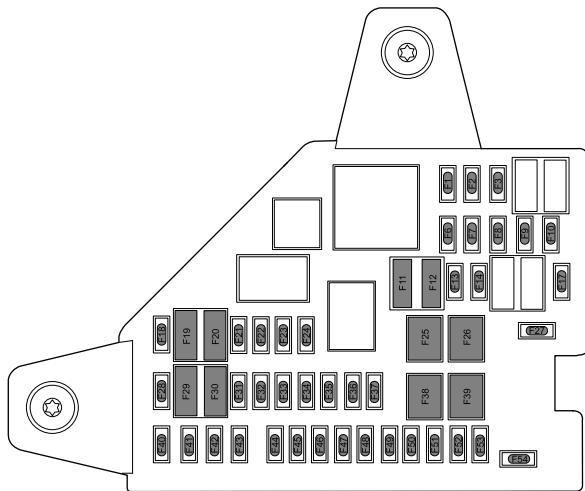

EMERGENCY INFORMATION

Check or Replace a Fuse

- 1 Turn off the START/STOP Switch and all electrical appliances, and disconnect the battery cable.
- 2 Remove the driver side dashboard panel cover to access the fuse box.
- 3 Hold the fuse head with the fuse extraction tool, pull and remove the fuse, and check if the fuse is blown.
- 4 If a fuse is blown, replace it with another fuse of the same ampere value.

Fuse Specification

Code	Specs	Function
F1	10A	Sensing Diagnostic Module (Airbag) , Electronic Shifter Control Unit , TBOX , Instrument Pack , Body Control Module , Airbag Display Module
F2	7.5A	Engine Control Module , Hybrid Control Unit

Code	Specs	Function
F3	5.0A	Front View Control Module , Front Detection Radar
F6	-	-
F7	15A	Towing Kit Connector Socket
F8	15A	Front Power Socket
F9	5A	USB Port
F10	-	-
F11	7.5A	Mirror Heaters
F12	25A	Rear Windscreen Heating
F13–F14	-	-
F17	-	-
F18	30A	Rear Left Window Lift
F19	5A	EPB Switch , PRND Display

EMERGENCY INFORMATION

Code	Specs	Function
F20	30A	Rear Right Window Lift
F21	10A	Front Right Seat Heating Relay
F22	5A	Diagnostic Line Connector
F23	10A	Front Left Seat Heating Relay
F24	10A	Gateway
F25	40A	KLR Relay
F26	30A	Passenger Window lift
F27	-	-
F28	5A	Passive Entry Passive Start Module , Backup Immobilizer Coil
F29	10A	Gateway
F30	5A	Driver Door Switch Pack , Rain Light Sensor

Code	Specs	Function
F31	-	-
F32	5A	Ambient Light Control Module
F33	5A	Sensing Diagnostic Module (Airbag)
F34	5A	TBOX
F35	10A	Radio Broadcasting Reception Module
F36	10A	Electronic Steering Column Lock
F37	20A	Driver Electric Adjust Seat Switch
F38	30A	Driver Window Lift
F39	30A	Blower
F40	15A	Entertainment System

EMERGENCY INFORMATION

Code	Specs	Function
F41	5A	Upper Console Switch
F42	10A	AC Control Module
F43	5A	Instrument Pack
F44	5A	Rear Driving Assistance System
F45	30A	Sunroof Motor
F46	5A	Tyre Pressure Monitoring System
F47	30A	Sunshade Motor
F48	20A	Passenger Electric Adjust Seat
F49	5A	Around View Module
F50	-	-

Code	Specs	Function
F51	30A	Rear Windscreen Heating Relay , Exterior Mirrors Relay
F52	10A	Headlamp , Interior Rear View Mirror , Headlamp Levelling Switch
F53	10A	Electronic Shifter Control Unit
F54	-	-

Front Compartment Fuse Box

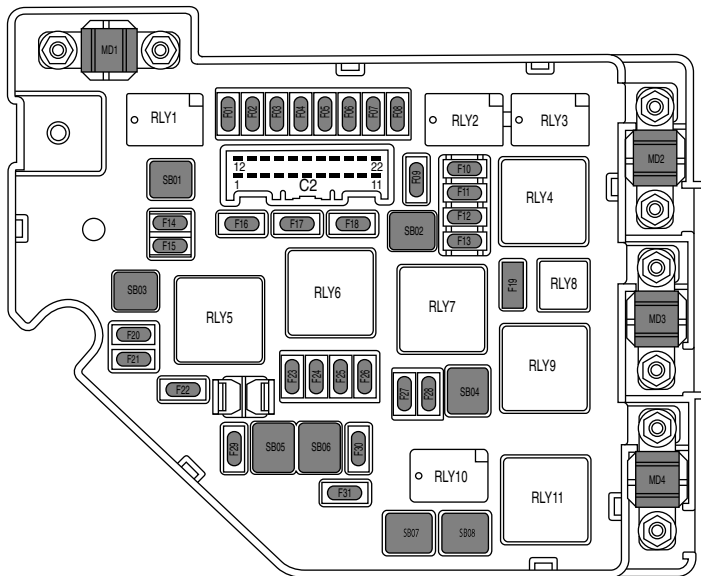

EMERGENCY INFORMATION

Check or Replace a Fuse

- 1 Turn off the START/STOP Switch and all electrical appliances, and disconnect the negative battery cable.
- 2 Press the lock catch to open the upper cover of front compartment fuse box.
- 3 Hold the fuse head with the fuse extraction tool, pull and remove the fuse, and check if the fuse is blown.
- 4 If a fuse is blown, replace it with another fuse of the same ampere value.

Fuse Specification

Code	Specs	Function
F01	10A	Right Headlamp Assembly
F02	10A	Left Headlamp Assembly
F03	10A	DC/DC Convertor
F04	-	-
F05	5A	Electric Air Conditioning Compressor

Code	Specs	Function
F06–F07	-	-
F08	20A	Power Electronic Box Coolant Pump
F09	10A	Fuel Pump Relay 、 Lower Console Switch 、 Fuel Tank Isolation Diagnosis Module (Tank Leakage)、 Brake Pedal Switch
F10	20A	Engine Control Module
F11	15A	Intake Variable Camshaft Timing 、 Exhaust Variable Camshaft Timing 、 Upstream Lambda Sensor 、 Downstream Lambda Sensor 、 Canister Purge Valve
F12	20A	Ignition Coil

EMERGENCY INFORMATION

Code	Specs	Function
F13	15A	Waste Gate Control Valve 、 Dump Valve 、 Electronic Thermostat 、 Mass Air Flow Sensor
F14	25A	Body Control Module
F15	10A	Rear Washer Relay
F16	25A	Body Control Module
F17	25A	Body Control Module
F18	25A	Body Control Module
F19	10A	Front Fog Lamp Relay
F20	10A	Front Washer Relay
F21	10A	Engine Control Module
F22	10A	Power Electronic Box
F23–F24	-	-
F25	30A	Hybrid Control Unit

Code	Specs	Function
F26	25A	Body Control Module
F27	-	-
F28	10A	Engine Auxiliary Pump
F29	15A	Horn
F30	10A	Hybrid Control Unit
F31	25A	Front Wiper Enable Relay
SB01	25A	Body Control Module
SB02	60A	Cooling Fan Low Speed Relay
SB03	40A	EVP Relay
SB04	40A	Cooling Fan
SB05	40A	Stability Control System-Pump
SB06	40A	Stability Control System-Valve
SB07	-	-

EMERGENCY INFORMATION

Code	Specs	Function
SB08	50A	Cooling Fan Middle Speed Relay
MD1	200A	Power Pump
MD2	100A	Passenger Compartment Fusebox
MD3	80A	Electric Power Steering Module
MD4	200A	Luggage Compartment Fusebox

Bulb Replacement

Bulb Specification

Bulb	Type
Dipped Beam and Main Beam (low configuration)	HB3SL+ 60W
Front Indicator Lamps (low configuration)	WY21W 21W
Front Fog Lamps	H8 35W
Front Interior Lamps (bulb configuration)	W5W 5W
Reverse Lamps	W16W 16W
License Plate Lamps	W5W 5W

Note: Bulb HB3SL+ is identical to a HB3 in shape and structure, it is superior in reliability and service life.

Note: Other light sources not included in the list are LED , which cannot be replaced individually.

Bulb Replacement

Before replacing any bulb, ensure that the START/STOP Switch and lighting switches are OFF so as to avoid any possibility of a short circuit. When replacing the bulb, actions should be gentle so as not to damage the lamp.

Note: Only replace bulbs with the same type and specification.

Note: If the bulb glass is scratched or contaminated, it may cause issues with the projected light pattern. Take care NOT to touch the glass with your fingers; If necessary, clean the glass with methylated spirits to remove fingerprints.

Consult an MG Authorised Repairer on specific replacement operation.

EMERGENCY INFORMATION

Dipped/Main Beam Headlamp Bulb Renewal

- 1 Open the bonnet—see “Bonnet” in the “Maintenance” section.
- 2 Disconnect the battery negative terminal.
- 3 Identify and locate the headlamp bulb cover plug, and remove it.
- 4 Rotate the bulb anti-clockwise and remove.
- 5 Remove the wiring connector from the bulb.
- 6 Refit the wiring connector to the new bulb.
- 7 Locate the bulb in the lamp, rotate clockwise until fully secured.
- 8 Locate the cover plug.
- 9 Connect the negative battery terminal.
- 10 Test headlamp operation.
- 11 Close the bonnet—see “Bonnet” in the “Maintenance” section.

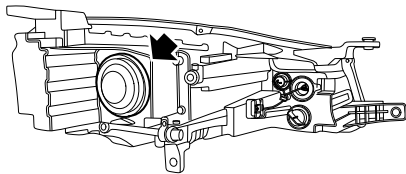

Front Indicator Lamp Bulb Renewal

- 1 Open the bonnet—see “Bonnet” in the “Maintenance” section.
- 2 Disconnect the battery negative terminal.
- 3 Rotate the bulb holder anti-clockwise and remove.

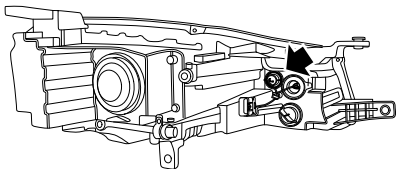

- 4 Remove the bulb from the holder.
- 5 Install new bulb into the holder.
- 6 Locate the bulb holder in the lamp, rotate clockwise until fully secured.
- 7 Connect the negative battery terminal.
- 8 Test lamp operation.

- 9 Close the bonnet—see “Bonnet” in the “Maintenance” section.

EMERGENCY INFORMATION

Front Fog Lamp Bulb Renewal

- 1 Disconnect the battery negative terminal.
- 2 Safely raise and support the front of the vehicle with suitable support equipment. DO NOT work under a vehicle that is only supported by a scissor or trolley jack.
- 3 Remove the bottom deflector.
- 4 Rotate the bulb holder anti-clockwise and remove.
- 5 Remove the wiring connector from the bulb holder.
- 6 Refit the wiring connector to the new bulb holder.
- 7 Locate the bulb holder in the lamp, rotate clockwise until fully secured.
- 8 Fit the bottom deflector.
- 9 Connect the negative battery terminal.
- 10 Test lamp operation.

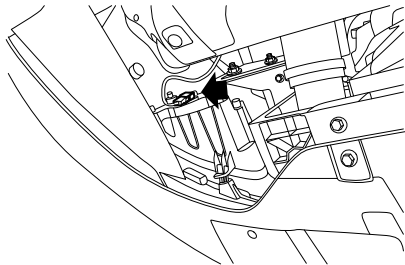

Reverse Lamp Bulb Renewal

- 1 Disconnect the battery negative terminal.
- 2 For reverse lamp bulb replacement, it is necessary to remove the rear bumper cover, seek guidance from an MG Authorised Repairer.
- 3 Rotate the bulb holder anti-clockwise and remove.

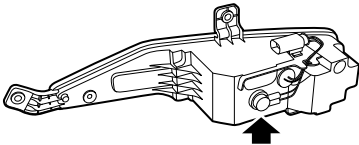

- 4 Remove the bulb from the holder.
- 5 Install new bulb into the holder.
- 6 Locate the bulb holder in the lamp, rotate clockwise until fully secured.
- 7 Fit the rear bumper.
- 8 Connect the negative battery terminal.

- 9 Test lamp operation.

EMERGENCY INFORMATION

License Plate Lamp Bulb Renewal

- 1 Open and support the tail gate—see “Alarm Systems” in the “Starting and Driving” section.
- 2 Disconnect the battery negative terminal.
- 3 Remove the tail gate interior trim panel (it may be necessary to consult MG Technical Information or an MG Authorised Repairer).
- 4 Remove the wiring connector from the lamp.

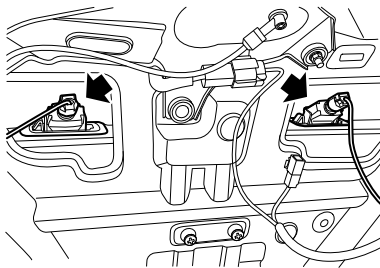

- 5 Rotate the bulb holder anti-clockwise and remove.

- 6 Remove the bulb from the holder.
- 7 Install new bulb into the holder.
- 8 Locate the bulb holder in the lamp, rotate clockwise until fully secured.
- 9 Refit the wiring connector
- 10 Fit the tail gate interior trim panel (it may be necessary to consult MG Technical Information or an MG Authorised Repairer).
- 11 Connect the negative battery terminal.
- 12 Close the tail gate.
- 13 Test lamp operation.

Front Interior Lamp Bulb Renewal

- 1 Disconnect the battery negative terminal.
- 2 Use a small flat-bladed screwdriver to gently prise the lens from the lamp assembly.

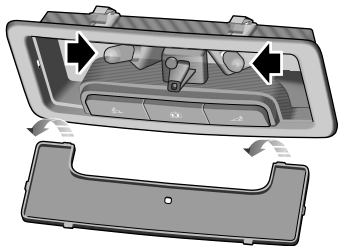

- 3 Remove the bulb from its mounting to remove.
- 4 Install new bulb.
- 5 Install the lens, locate the two prongs at the front of the lens and then carefully flex the lens to locate the two prongs at the rear of the lens into the lamp

assembly. Push the lens upwards until it 'clicks' into position

- 6 Connect the negative battery terminal.
- 7 Test lamp operation.

Maintenance

292 Maintenance

295 Bonnet

297 Engine Compartment

298 Engine

300 Cooling System

302 Brake

304 Battery

306 High Voltage Battery Pack

308 Washer

310 Wipers

313 Tyres

319 Cleaning and Vehicle Care

MAINTENANCE

Maintenance

Routine Servicing

The safety, reliability and performance of your car will depend partly on how well it is maintained. You must ensure that maintenance is carried out when required and according to the information contained in the "Service Schedule" - see www.mg.co.uk - owners section.

Servicing

For next service information, please refer to "Message Centre" in "Instruments and Controls" chapter or information related to entertainment system. After the completion of each service, the next service display will be reset by MG Authorised Repairer.

Note: If a service is not carried out (or the display is not reset by a MG Authorised Repairer after service), the service display cannot provide correct information

Service History

Ensure MG Authorised Repairer registers the Service History after each service.

Brake Fluid Replacement

Replace the brake fluid according to the "Service Schedule" requirements.

Note: Brake fluid replacement will be an additional cost.

Coolant Replacement

The coolant (anti-freeze and water solution) needs to be replaced according to the "Service Schedule" requirements.

Note: Coolant replacement will be an additional cost.

Emission Control

Your car is fitted with exhaust emission and evaporative control equipment designed to meet specific territorial and legal requirements. Incorrect engine settings may adversely affect exhaust emissions, engine performance and fuel consumption, as well as causing high temperatures, which could result in damage to the catalytic converter, particulate filter and engine.

IMPORTANT

You should be aware that unauthorised replacement, modification or tampering with engine settings or this equipment by an owner or motor vehicle repairer could result in the manufacturer's warranty being deemed as invalid.

Owner Maintenance



Any significant or sudden drop in fluid levels, or uneven tyre wear, should be reported without delay. For further information, refer to an MG Authorised Repairer.

In addition to the routine services referred to previously, a number of simple checks must be carried out more frequently. You can perform such checks by yourself. Advice is given as follows.

Daily Check

- Operation of lights, horn, direction indicator lamps, wipers, washers and warning lights.
- Operation of seat belts and brakes.

- Look for fluid deposits underneath the car that might indicate a leak.
- Check tyre appearance.

Weekly Check

- Engine oil level.
- Coolant levels.
- Brake fluid level.
- Windscreen washer fluid level.
- Operate air conditioning.

Note: The engine oil level should be checked more frequently if the car is driven for prolonged periods at high speeds.

Special Driving Conditions

If your car is frequently used in dusty conditions, or operated in extreme climates where sub-zero or very high ambient temperatures are normal, more frequent attention may need to be paid to servicing requirements. You need to carry out special maintenance operations (refer to the service schedule in the owners section at www.mg.co.uk or contact MG Authorised Repairer).

MAINTENANCE

Safety in the Garage



Cooling fans may commence operating after the engine or vehicle power system is switched off, and continue operating for a number of minutes. Keep clear of all fans while working in the engine compartment.

If you need to carry out maintenance, observe the following safety precautions at all times:

- Keep your hands and clothing away from drive belts and pulleys.
- If the car has been driven recently, **DO NOT TOUCH** exhaust and cooling system components until the engine/electric transmission has cooled.
- **DO NOT TOUCH** electrical leads or components while the engine is running, or with the **START/STOP** Switch on.
- **NEVER** leave the engine running in an unventilated area - exhaust gases are poisonous and extremely dangerous.
- **DO NOT** work underneath the car with a wheel changing jack as the only means of support.

- Ensure that sparks and naked lights are far away from the engine compartment.
- Wear protective clothing and work gloves.
- Remove watches and jewelry before working in the engine compartment.
- **DO NOT** allow tools or metal parts of the car to make contact with the battery leads or terminals.

Toxic Liquid

Fluids used in motor vehicles are poisonous and should not be consumed or brought into contact with open wounds. These include: battery acid, coolant, brake fluid, fuel, engine oil and windscreen washer fluid.

For your own safety, **ALWAYS** read and obey all instructions printed on labels and containers.

Used Engine Oil

Prolonged contact with engine oil may cause serious skin disorders, including dermatitis and cancer of the skin. Wash thoroughly after contact. Used engine oil should be disposed of correctly. Incorrect disposal can cause a threat to the environment.

Bonnet

Opening the Bonnet



DO NOT drive when the bonnet is open or retained only by the safety catch.

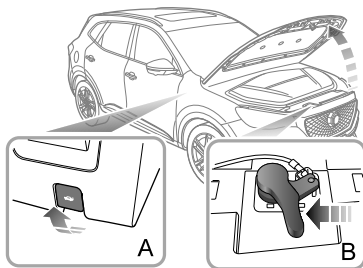

- 1 Pull the bonnet release handle (A) from the inside of the car.
- 2 Push the lever (B) mounted on the bonnet in the direction of the arrow to release the bonnet safety catch.
- 3 Raise the bonnet to open it.

Closing the Bonnet

Hold the bonnet using both hands and lower it, allowing it to drop for the last 20 ~ 30 cm to fully close the bonnet.

By attempting to lift the front edge of the bonnet, check if the lock is fully engaged after closing the bonnet. If it is not fully engaged, please reopen the bonnet and repeat the closing action.

Bonnet Open Warning

If the bonnet is not fully engaged, when the START/STOP Switch is in the ON/READY position, the corresponding alarm icon will be displayed in the information message centre of the instrument pack. If it is detected that the

MAINTENANCE

bonnet is not fully engaged whilst driving, an audible warning will sound.

IMPORTANT

- For safety reasons, the bonnet should be fully latched and secure when driving. Therefore every time the bonnet is opened, you must check after closing that the bonnet is securely latched, e.g. the bonnet edge is flush with the body of the car.
- You should stop the car immediately when safety permits and close the bonnet if it is not closed fully when driving.
- Beware of injury to hands while fully closing the bonnet with a downward force.

Engine Compartment



While working in the engine compartment, always observe the safety precautions listed under "Safety in the Garage". Refer to "Maintenance" in "Maintenance" section.

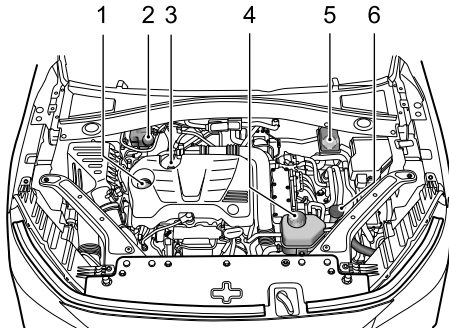

- 1 Engine oil filler cap (black cap)
- 2 Brake fluid reservoir (yellow cap)
- 3 Engine oil dipstick (yellow)
- 4 Engine coolant expansion box (black cap)
- 5 Electric drive transmission coolant expansion box (black cap)
- 6 Washer fluid reservoir (blue cap)

MAINTENANCE

Engine

1.5L Turbocharged Engine Oil

ACEA Classification of Engine Oils

European Automobile Manufacturers Association (ACEA) will classify the engine oils based on performance and quality. To ensure the best performance of the vehicle, please only use engine oils that are recommended by the manufacturer (see "Technical Data" - 'Recommended Fluids and Capacities').

If you are operating the vehicle in extreme temperature conditions please consult your MG Authorised Repairer for advice.

Engine Oil Level Check and Top Up



Driving the car with the oil level ABOVE the upper mark, or BELOW the lower mark on the dipstick, will damage the engine. Take care to avoid spilling engine oil onto a hot engine –Spillages may result in a fire!

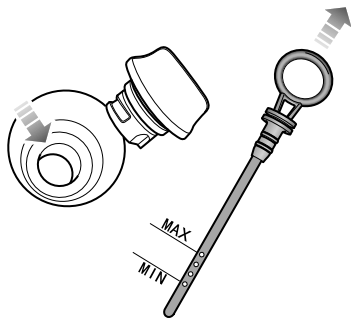

1.5L Turbocharged Engine

Check the oil level weekly and top up with oil when necessary. Ideally, the oil level should be checked with the engine cold and the car resting on level ground. However, if the engine is running and already getting warm, wait for at least five minutes after switching off the START/STOP Switch before checking the level.

- 1 Withdraw the dipstick and wipe the blade clean.
- 2 Slowly insert the oil dipstick and pull it out again to check the oil level; the oil level shall not be lower than the 'MIN' mark on the oil dipstick.
- 3 Unscrew the oil filler cap and refill the oil to maintain the oil level between the 'MAX' mark and 'MIN' mark on the oil dipstick.
- 4 Wait for 5 minutes and then recheck the oil level, adding more oil if necessary – DO NOT OVERFILL!
- 5 Finally, ensure the dipstick and filler cap are replaced.

Engine Oil Specification

Use the engine oil recommended and approved by the manufacturer. Refer to "Recommended Fluids and Capacities" in "Technical Data" chapter.

Note: DO NOT use any oil additives.

IMPORTANT

Check the engine oil more frequently if the car is driven at high speeds for prolonged periods.

MAINTENANCE

Cooling System

Coolant Check and Top Up



DO NOT remove cooling system caps when the cooling systems are hot - escaping steam or hot coolant could cause serious injury.

It is recommended that the cooling systems should be checked weekly when the cooling systems are cold and with the car resting on level ground. If the level is below the 'MIN' mark, remove the expansion tank cap and top up coolant, the level must not be higher than 'MAX' mark.

Note: Prevent coolant coming into contact with the vehicle body when topping up. Coolant will damage paint.

If the coolant level falls appreciably during a short period, and you suspect that there may be a leak, please seek an MG Authorised Repairer for service.

Engine Coolant Expansion Tank and EDS Coolant Expansion Tank

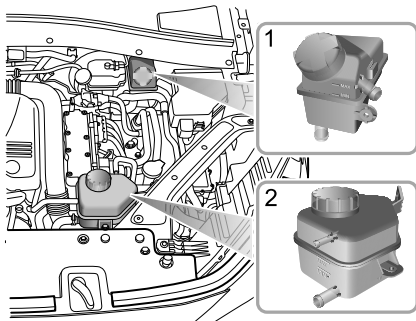

- 1 EDS Coolant Expansion Tank
- 2 Engine Coolant Expansion Tank

Battery Coolant Expansion Tank

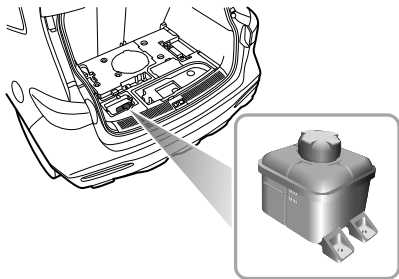

Coolant Specification



Coolant is poisonous and can be fatal if swallowed - keep coolant containers sealed and out of the reach of children. If accidental contact of coolant by children is suspected, seek medical assistance immediately.



Prevent coolant coming into contact with the skin or eyes. If this occurs, rinse immediately with plenty of water. If eyes are still red, painful or uncomfortable, seek medical attention immediately.

Please use the coolant recommended and certified by the manufacturer. Refer to 'Recommended Fluids and Capacities' in "Technical Data" chapter.

Note: In an emergency, top up the coolant reservoir with a small amount of clean water. However, it should be noted that this will weaken the protection and reduce the service life of the coolant. DO NOT refill the cooling system with coolant of different formulations.

Note: The addition of corrosion inhibitors or other additives to the cooling system of this car may severely disrupt the efficiency of the system and cause parts damage. For cooling system issues please consult an MG Authorised Repairer.

MAINTENANCE

Brake

Brake Pads



DO NOT rest your foot on the brake pedal while driving; this may overheat the brakes, reduce their efficiency and cause excessive wear.

For the first 900miles (1500km), you should avoid situations where heavy braking is required.

Remember that regular servicing is vital to ensure that all the brake components are examined for wear at the correct intervals, and replaced when required to ensure long term safety and optimum performance during the interval prescribed in Service Schedule.

The car needs to run in for 500miles (800km) after the brake pad or discs are replaced.

Brake Fluid Check and Top Up



Brake fluid is highly toxic, keep containers sealed and out of the reach of children. If accidental contact of brake fluid is suspected, seek medical attention immediately.



Prevent brake fluid coming into contact with the skin or eyes. If this occurs, rinse immediately with plenty of water. If eyes are still red, painful or uncomfortable, seek medical attention immediately.

The brake fluid level should be checked weekly when the system is cold and with the car on level ground.

The fluid level can be seen through the reservoir and should be maintained between 'MAX' and 'MIN' mark.

Note: Do not allow the level to drop below the 'MIN' mark or rise above 'MAX' mark.

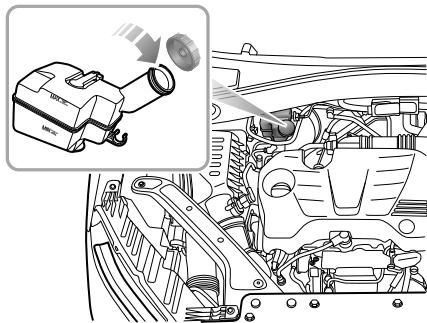

Note: Brake fluid will damage painted surfaces. Soak up any spillage with an absorbent cloth immediately and wash the area with a mixture of car shampoo and water.

Brake Fluid Specification

Use the brake fluid recommended and certified by the manufacturer. Refer to "Recommended Fluids and Capacities" in the "Technical Data" chapter.

IMPORTANT

Replace brake fluid regularly according to the Service Schedule.

MAINTENANCE

Battery

Battery Maintenance



DO NOT leave electric components switched on when the vehicle is not in **READY** mode, otherwise the battery may become flat, resulting in the failure to start the vehicle and the reduction of battery life.



Always store batteries upright, tilting may allow the corrosive substances contained within the battery to leak out.



Never attempt to dismantle a battery, they are sealed units.

The battery will become visible when you open the tailgate and lift the carpet. The battery is a maintenance-free type, therefore there is no need to refill fluid.

Note: It is recommended to start the vehicle for half an hour every week to help extend the service life of the battery. If the vehicle is stored for more than 1 month, remove the negative terminal from the battery. Make

sure that the **START/STOP** Switch has been turned off before connecting or disconnecting the negative terminal.

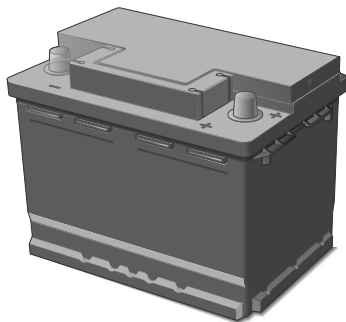

Battery Replacement



The battery contains sulphuric acid, which is corrosive.

The battery contains sulphuric acid, which is corrosive. Please go to an MG Authorised Repairer to remove and install the battery. Only fit a replacement battery of the same type and specification as the original to maintain the correct vehicle functionality.



The battery must be disposed of using an approved method, used batteries can be harmful to the environment. It should be recycled by a professional company. Please consult an MG Authorised Repairer for more details.

MAINTENANCE

High Voltage Battery Pack

Precautions and restricted conditions for use of battery



If the vehicle is not going to be used, parked, or stored for a long time it is necessary to charge the vehicle at least once every 3 months. During this time, the High Voltage battery state of charge should not be allowed to drop below 50%.



Failure to follow these guidelines will result in HV battery damage and invalidate the warranty.



DO NOT attempt to dismantle the battery pack or any High Voltage components - THESE ARE DANGEROUS. Any signs of dismantling or damage caused by attempts to dismantle will invalidate the warranty.

- I DO NOT park the vehicle in conditions where the ambient temperature exceeds 45 °C for more than 15

days. This will effect the performance and service life of the high voltage battery.

- 2 It is recommended using the vehicle at least once a month.

Where possible it is recommended that you carry out a 5-hour slow charge every month to extend the service life of high-voltage battery pack. If the vehicle is not in use for a long time, make sure that the electricity charge level of high-voltage battery pack is displayed as 3 ~ 5 segments on the instrument pack gauge; if it is not in use for more than 3 months, you must conduct an equalisation charge for high-voltage battery pack.

The battery management system will monitor the status of the high- voltage battery pack; after monitoring for a period of time, if an equalisation charge has not been carried out for some time the message centre in the instrument pack will display 'Please Slow-Charge the Vehicle'. At this time you must carry out an equalisation charge. For operation mode, please refer to 'Equalisation Charging' in 'Starting & Driving' section.

- 3 In the event of an accident, damage to the high voltage battery or any of its related components, or any repairs made to the high voltage system the car must be inspected by qualified personnel at an MG Authorised Repairer.
- 4 In the event of any accident or body repairs being required please consult the qualified personnel at an MG Authorised Repairer. The repair may require high voltage battery isolation or specialist HV component removal.

IMPORTANT
Only fully trained and qualified personnel are allowed to work on the high voltage systems and components of this vehicle. Any disassembly of such systems or components is strictly prohibited.

MAINTENANCE

Washer

Washer Fluid Check and Top Up



Windscreen washer fluid is flammable. DO NOT allow windscreen washer fluid to come into contact with naked flames or sources of ignition.



When filling the washer fluid, DO NOT let the washer fluid spill on parts around the engine or electric transmission or on the paint surface of vehicle body. In case the washer fluid is spilled on hands or other parts of the body, please immediately wash with clean water.

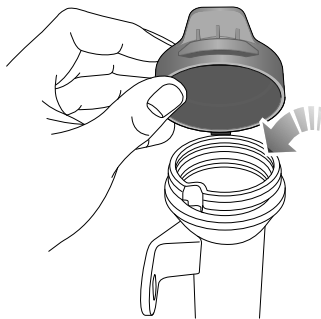

Check the washer fluid level regularly. When the level of washer fluid is low, please top up the washer fluid as instructed. Please use the washer fluid recommended and certified by the manufacturer. Refer to 'Recommended Fluids and Capacities' in "Technical Data" chapter.

Note: DO NOT use an anti-freeze or vinegar/water solution in the washer reservoir - anti-freeze will

damage paintwork while vinegar will damage the washer pump.

IMPORTANT

- Use the washer fluid recommended and certified by the manufacturer. Misuse of washer fluid in winter may cause damage to the washer motor due to freezing.
- Using the washer switch when there is no washer fluid may cause damage to the washer motor.
- Operating the wipers when the windscreen is dry and there is no washer fluid may cause damage to the windscreen and wipers. Please spray the washer fluid and start the wipers when there is adequate washer fluid.

Washer Nozzles

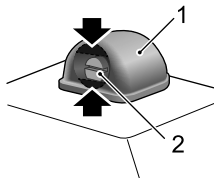

Operate the washers periodically to check that the nozzles are clear and properly directed.

The windscreen washer nozzles are configured during the production. To adjust the windscreen washer nozzle, you can insert a small flat-bladed screwdriver in the upper and bottom gaps (as indicated by the arrow) between the housing (1) and the nozzle (2) and turn downward or upward slightly to adjust to the appropriate spray angle.

If the nozzle is obstructed, insert a needle or thin metal wire into the hole to remove the obstruction.

MAINTENANCE

Wipers

Wiper Blades

IMPORTANT

- Grease, silicon and petroleum products impair the blade's wiping capability. Clean the wiper blades in warm soap water, and check their status periodically.
- Clean the windscreen frequently. **DO NOT** use wipers to remove stubborn or ingrained dirt, it will reduce their effect and their life span.
- If signs of hardness or cracking in the rubber are found, or if the wipers leave streaks or unwiped areas on the screen, then the wiper blades should be replaced.
- Clean the windscreen regularly with an approved glass cleaner and ensure the windscreen is thoroughly cleaned before fitting replacement wiper blades.
- Only fit replacement wiper blades that are identical to the original specification.
- Clean ice and snow from the wipers and ensure they are not frozen or otherwise sticking to the windscreen before attempting to operate them.

Replacing Front Windscreen Wiper Blades

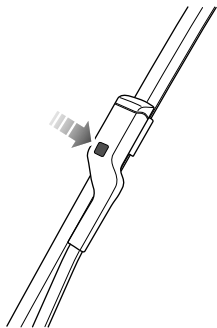

- 1 With the bonnet in closed state, and within 20 seconds of setting the START/STOP Switch to the OFF position, operate the wiper stalk switch by pressing down and release, the wipers will enter the 'service position' and stop on the windscreen.
- 2 Lift the wiper arm away from the windscreen.
- 3 Press the button on the wiper arm (as illustrated), and pull the upper end of the wiper blade outward to disengage from the wiper arm.
- 4 Unhook the blade from the wiper arm and discard.
- 5 Locate the new wiper into the slot of the wiper arm.
- 6 Push the wiper blade towards the arm until the wiper blade is engaged.
- 7 Check whether the wiper blade is fitted correctly to the arm before positioning on the windscreen.
- 8 Operate the wiper stalk switch by pressing down again and release, or set the Start/Stop Switch to ON, the wiper will exit the service mode and automatically return to its original position

MAINTENANCE

Replacing Rear Window Wiper Blades

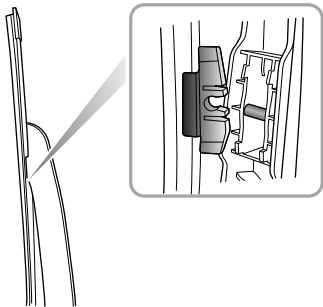

- 1 Lift the wiper arm away from the windscreen.
- 2 Pull the wiper blade connector outward with moderate force to separate it from the wiper arm and discard the wiper blade.
- 3 Position the fitting of the new wiper blade into the slot of the wiper arm. Ensure the wiper blade is properly secured on the wiper arm.
- 4 Place the wiper assembly back on the windscreen.

Tyres

Overview

- Take extra care when using new tyres for the first 300miles.
- Avoid excessive cornering at speed.
- Regularly check tyres for signs of damage. DO NOT remove foreign objects such as screws or nails from the tyre. If a tyre shows any signs of damage please ensure it is inspected by a reputable tyre fitter for advice.
- Prevent tyres coming into contact with any chemicals such as oil, grease or fuel.
- Ensure valve caps are always fitted.
- If the tyre is to be removed always mark the tyre/wheel orientation to ensure correct refitment.

New Tyres

New tyres may not have the same adhesion properties of the old tyres, please take extra care for 300miles. This action could benefit tyre life.

The damage of a tyre or rim may happen unnoticed. If abnormal vibration or handling is experienced, that means

the tyre or rim may have been damaged. Please slow down and park your vehicle in a suitable, safe location, then check the tyre and rim. If you can't see the damage from the outside continue to drive the vehicle slowly to a reputable tyre fitter or MG Authorised Repairer for inspection and advice.

Directional Tyres

Directional tyres are marked with 'direction of rotation' (DOR). To maintain handling characteristics, tyre performance, low road noise and extend tyre life, tyres must always be fitted with indication arrow showing the correct 'DOR'.

Tyre Life

Correct tyre pressures and moderate driving style can extend tyre life. Recommendations:

- If the vehicle is to be stored for a lengthy time, please move your vehicle at least once every two weeks to 'rotate the tyres'.
- Tyre pressures should be checked monthly when the tyres are cold.

MAINTENANCE

- Avoid cornering at excessive speeds.
- Regularly check tyres for abnormal wear patterns.

The following factors affect the tyre life:

Tyre Pressures

Incorrect tyre pressures can result in poor driving characteristics and a shortened tyre life. Tyre pressures should be checked at least once a month, and once prior to each long-distance journey.

Driving Style

Excessively harsh acceleration and braking whilst cornering will reduce tyre life.

Wheel Balance

Every new vehicle leaves the factory having had the wheels dynamically balanced. Out of balance wheels may be due to many factors. If wheels are out of balance, shaking or vibration of the steering mechanism may occur and the tyres may start to wear excessively. It is important to restore wheel balance as quick as possible. Each wheel

should be rebalanced after installing a new tyre or having a tyre repair.

Wheel Alignment

Incorrect wheel alignment can cause excessive tyre wear and affect vehicle safety. If the tyres show signs of abnormal wear, check the wheel alignment and seek advice from an MG Authorised repairer.

Caring for Your Tyres



DEFECTIVE TYRES ARE DANGEROUS!
DO NOT drive if any tyre is damaged, is excessively worn, or is inflated to an incorrect pressures.

Always drive with consideration for the condition of the tyres, and regularly inspect the tread and side walls for any sign of distortion (bulges), cuts or wear.

Note: If possible, protect tyres from contamination by oil, grease and fuel.

Tyre Pressures



Before a long distance journey, the tyre pressure must be checked.

Check the pressures (including the spare wheel) at least every month, when the tyres are cold.

If it is necessary to check the tyres when they are warm, you should expect the pressures to have increased by 30 ~ 40kPa/0.3 ~ 0.4bar/4.3 ~ 5.8psi. In this circumstance,

NEVER let air out of the tyres in order to match the recommended pressures (cold).

Valves

Keep the valve caps screwed down firmly - they prevent dirt from entering the valve. Check the valve for leaks (listen for a tell-tale hissing) when you check the tyre pressure.

Punctured Tyres

Your vehicle is fitted with tyres which may not leak if penetrated by a sharp object, provided the object remains in the tyre. If you are aware of this occurring, reduce speed immediately and drive with caution until the spare wheel can be fitted, or repairs undertaken.

Note: If the sidewall of the tyre is damaged or distorted, replace the tyre immediately, do not attempt a repair.

Tyre Wear Indicators

Tyres fitted as original equipment have wear indicators moulded into the tread pattern at several points around the circumference. When the tread has worn down to 1.6mm,

MAINTENANCE

the indicators will come to the surface of the tread pattern, producing the effect of a continuous band of rubber across the width of the tyre.

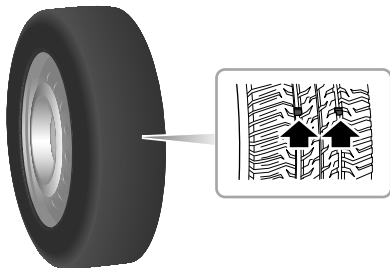

IMPORTANT

A tyre **MUST** be replaced as soon as a wear indicator becomes visible.

Replacement of Tyres



When replacing tyres it is strongly recommended that the new tyres are of the same specification as the original tyres. DO NOT replace the tyres with tyres of any other type. Alternative tyres, of a different specification, may adversely affect the vehicle's driving characteristics and safety. In order to make your driving and safety better guarantee, it is suggested that you consult an MG Authorised Repairer.

Always have replacement wheels and tyres balanced before use.

Wheel Fitment Rotation

It is not recommended that you swap wheels from side to side or front to rear in order to equalise tyre wear. Your vehicle is fitted with a Tyre Pressure Monitoring System which means that each wheel is programmed to the relative position.

If you do wish to swap wheels and tyres around on the vehicle please consult an MG Authorised Repairer as extra coding will be required.

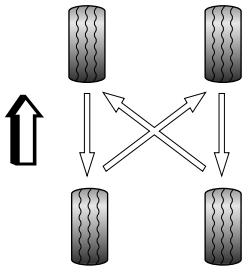

Note: *Directional tyres (identified from the arrow on the tyre side) CANNOT be swapped from side to side.*

Note: *TPMS coding is required after changing wheel positions, please consult an MG Authorised Repairer for details.*

Tyre/Snow Chains

Unsuitable tyre/snow chains may damage the tyres, wheels, suspension, brakes or bodywork of your car.

Please pay attention to the following requirements in the usage:

- The tyre/snow chains can only be fitted on the drive wheels;
- The thickness of tyre/snow chains shall not exceed 15 mm;
- Please always observe the installation and tension instructions for the tyre/snow chains, as well as the speed limitations of different roads;
- Do not drive faster than 30 mph;
- To avoid the tyre damage and excessive wear of the tyre/snow chains, the tyre/snow chains must be removed while driving on the road without snow.

Snow Chain Applications

Snow chains cannot be fitted to all wheel/tyre sizes.

Please note: On this vehicle, snow chains can only be fitted to:

MAINTENANCE

Wheel rim size: 6.5J×17

Tyre size: 215/60 R17

Note: *If you drive on snowy and icy roads, it is recommended to use winter tyres. Consult an MG Authorised Repairer for details.*

Cleaning and Vehicle Care



Observe all safety precautions on cleaning products, they can be harmful; do not drink fluids, keep them out of reach of children and avoid contact with the eyes.

External Care

Washing Your Car



Some high pressure cleaning systems will penetrate door, window and sunroof seals, and damage lock mechanisms. DO NOT aim water jets directly at components that might be easily damaged.



Water or moisture on parts of the braking system will reduce braking performance, this may increase the risk of accidents. Ensure the vehicle power system is OFF when washing your car, there may be risk of injury or accident.



DO NOT use a high pressure hose to clean the engine compartment – damage to the car's electronic systems may occur.

In order to preserve the paint finish on your car, please observe the following care points:

- DO NOT use hot water to wash the car.
- DO NOT use detergents or washing up liquid.
- In hot weather, DO NOT wash the car in direct sunlight.
- When using a hose, DO NOT aim the water directly at a window, door or sunroof seals, or through wheel apertures onto the brake components.

If the car is particularly dirty, use a hose to flush grime and grit from the bodywork, prior to washing. Then, wash the car using cold or lukewarm water containing a good quality wash and wax shampoo. Always use plenty of water to ensure that grit is flushed from the surface and not ground into the paintwork. After washing, rinse the bodywork with clean water and dry off with a chamois leather.

Cleaning the underside

MAINTENANCE

Note: DO NOT use a high pressure hose to clean the front compartment – damage to the car’s electronic systems may occur.

From time to time, but particularly during winter months when salt has been used on the roads, use a hose to wash the underside of the car. Flush away accumulations of mud and thoroughly clean those areas where debris can easily collect (wheel arches and panel seams, for example).

IMPORTANT

- Avoid cleaning the vehicle in direct sunlight.
- When cleaning the vehicle in winter avoid spraying water directly onto door locks and panel gaps due to risk of icing.
- Do not use rough sponges or cloth to clean the car, this will damage the paintwork finish.
- When cleaning the headlamps do not use a dry cloth or sponge, use only warm soapy water.

Cleaning with High Pressure Cleaner

Always read the manufacturers operating instructions.

When using high pressure washers, always ensure there is adequate distance between the spray nozzle and any soft materials, decals or rubber seals.

Note: DO NOT direct the pressure washer nozzle directly toward the high voltage charging points or high voltage battery connections on the underside of the vehicle.

IMPORTANT

- Please pay attention to the operating instructions of high pressure cleaner.
- Soft parts on the vehicle should be kept in a large enough distance from the high pressure cleaner.

Body Protection

After washing, examine the paintwork for damage. If the damage has revealed bare metal, use a colored primer first, then apply the correct colour base coat and finish off with a lacquer pencil, if appropriate. Carry out this treatment after washing but before polishing or waxing. More extensive damage to paint or bodywork must be repaired in accordance with the manufacturer’s recommendations.

Failure to do this will invalidate the Anti-Corrosion Warranty. If in doubt, ask your MG Authorised Repairer.

Removing tar spots

Use white spirit to remove tar spots and stubborn grease stains from the paintwork. Then wash the area immediately with soapy water to remove all traces of the spirit.

Polishing the Paintwork



DO NOT use car polish containing coarse abrasives – these will remove the paint film and damage the gloss finish.

Occasionally treat the paint surface with an approved polish containing the following properties:

- Very mild abrasives to remove surface contamination without removing or damaging the paint.
- Filling compounds that will fill scratches and reduce their visibility.
- Wax to provide a protective coating between the paint and the elements.

Note: If possible, avoid applying polish or wax products to window glass and rubber seals.

Wiper Blades

Wash in warm soapy water. DO NOT use spirit or petrol based cleaners.

Windows and Mirrors

Regularly clean all windows, inside and out, using an approved glass cleaner.

Windscreen: In particular, clean the outside of the screen with glass cleaner after washing the car with wash and wax products, and before fitting new wiper blades.

Rear screen: Clean the inside with a soft cloth, using a side to side motion to avoid damaging the heating elements. DO NOT scrape or use abrasive cleaners – this will damage the heating elements.

Rearview mirrors: Wash with soapy water. DO NOT use abrasive cleaning compounds or metal scraper.

MAINTENANCE

Plastic Parts

Any plastic components should be cleaned using conventional cleaning methods and not be treated with abrasive materials. Stubborn stains or marks can be removed using proprietary plastic cleaning materials.

Paint Damage

Any paint damage or stonechips should be treated with suitable paint/lacquer materials immediately to avoid invalidating the Anti Corrosion Warranty.

Weather Strips

Any weather strips or rubber aperture seals should be treated with suitable materials (silica gel) if they are cleaned using strong detergents, this should avoid any sticking and maintain the service life of the seal.

Wheels



When cleaning the wheels any materials or water that contact the brake disc directly may effect braking efficiency.

In order to ensure the wheels are kept in optimum condition they should be cleaned regularly.

Only use a recommended non-acidic propriety wheel cleaner. Always read the instructions on the product.

Cleaning the Interior

Plastic materials

Clean plastic-faced materials with diluted upholstery cleaner, then wipe with a damp cloth.

Note: *DO NOT polish dashboard components – these should remain non-reflective.*

Carpet and fabrics

Clean with diluted upholstery cleaner - test a concealed area first.

Leather

Clean leather trim with warm water and a non-detergent soap. Dry and polish the leather with a dry, clean, lint-free cloth.

Note: *DO NOT use petrol, detergents, furniture creams or polishes as cleaning agents.*

Instrument Pack, Audio and Navigation Display

Clean with a dry cloth only. **DO NOT** use cleaning fluids or sprays.

Airbag Module Covers



DO NOT allow these areas to be flooded with liquid and DO NOT use petrol, detergent, furniture cream or polishes.

To protect damage to the airbag SRS, the following areas should be cleaned sparingly with a damp cloth and upholstery cleaner **ONLY**:

- Steering wheel centre pad.
- Area of dashboard containing the passenger airbag.
- Area of roof lining which encloses the side head impact protection airbags.

Seat Belts



DO NOT use bleaches, dyes or cleaning solvents on seat belts.

MAINTENANCE

Extend the belts, then use warm water and a non-detergent soap to clean. Allow the belts to dry naturally; **DO NOT** retract them or use the car until they are completely dry.

Technical Data

326 *Technical Data Dimensions*

328 *Weights*

332 *Major Parameters of Engine*

333 *Parameters of Drive Motor*

334 *Recommended Fluids and
Capacities*

335 *Four-Wheel Alignment Parameter
Table (Unladen)*

335 *Wheels and Tyres*

335 *Tyre Pressure (Cold)*

TECHNICAL DATA

Technical Data Dimensions

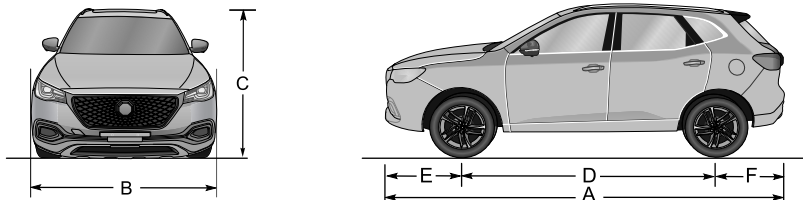

Item, Units	Parameter
Overall length A, mm	4574
Overall width B, mm	1876
Overall height C (unladen), mm	1664 (with body) 1685 (with shark fin)
Wheelbase D, mm	2720
Front Overhang E, mm	963
Rear Overhang F, mm	891

TECHNICAL DATA

Item, Units	Parameter
Front wheel track, mm	1574
Rear wheel track, mm	1593
Minimum ground clearance (laden), mm	145
Minimum turning circle diameter, m	11.9
Fuel tank capacity, l	37

Note: *Vehicle length not including the license plate.*

Note: *Rearview mirrors and the deformed portion of tyre wall directly above the touchdown point are not included in the total width.*

TECHNICAL DATA

Weights

Item, Units	Parameter	
	Trim Level 2	Trim Level 3
Person in cab, person	5	
Unladen vehicle weight (kerb), kg	1737	1775
Gross vehicle weight, kg	2196	2196
Unladen front axle weight, kg	966	985
Unladen rear axle weight, kg	771	790
Laden front axle weight, kg	1095	1095
Laden rear axle weight, kg	1101	1101

Towing Weights

Item, Units	Parameters
Towing limit unbraked, kg	750
Towing limit braked, kg	1500
Towing hitch load, kg	75

Note: When towing a trailer, the vehicle speed **MUST** not exceed 60mph (100km/h).

Note: Prior to towing a trailer, please check the rear tyre pressures, inflate to at least 20kPa (0.2bar) above the recommended pressure - **DO NOT** allow the tyre pressure to exceed 300kPa (3.0 bar), this can be dangerous.

TECHNICAL DATA

Towing Bar Dimensions

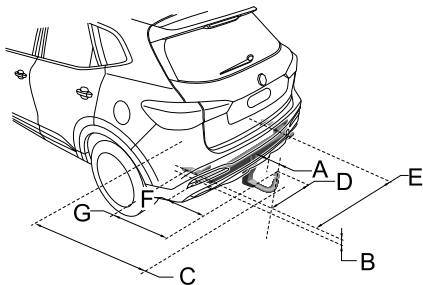

Item	Dimension Description, Units	Parameters
A	Bumper to centre of tow ball, mm	77
B	Attachment point to centre the tow ball, mm	55
C	Wheel centre to centre of tow ball, mm	954
D	Centre of tow ball to side member, mm	499

TECHNICAL DATA

Item	Dimension Description, Units	Parameters
E	Distance between side members, mm	998
F	Centre of tow ball to centre of first attachment point, mm	294
G	Centre of tow ball to centre of second attachment point, mm	508

TECHNICAL DATA

Major Parameters of Engine

Vehicle	Parameter
	1.5T
Bore × Stroke, mm × mm	74×86.6
Capacity, l	1.490
Compression ratio	11.5:1
Fuel type, RON	Unleaded 95 RON to EN228 SPEC

Parameters of Drive Motor

Item	Parameter
Rated Power/Speed/Torque (EV Mode), kW/rpm/Nm	35/4500/75
Peak Power/Speed/Torque (EV Mode), kW/rpm/Nm	90/12000/230 (2s) 90/12000/180 (10s)
Rated Output Voltage (Power Generation Mode), V	326
Rated Output Power/Speed (Power Generation Mode), kW/rpm	35/4500
Maximum Speed, rpm	12000
Drive Motor Controller Input Voltage, V	326

TECHNICAL DATA

Recommended Fluids and Capacities

Name	Grade	Capacity
Engine lubricating oil (after-sales replacement), L	C5 0W-20	4
Engine coolant , L	Glycol (OAT)	5
Electric drive transmission coolant, L		2.4
High-voltage battery pack coolant, L		4.4
Electric drive transmission oil, L	Castrol BOT 35I LV	4.4
Brake fluid, L	DOT 4	0.8
Windshield detergent, L	ZY-VIII	2.5
Air conditioning refrigerant, g	RI234yf	750±20

Four-Wheel Alignment Parameter Table (Unladen)

Item		Parameter
Front	Camber angle	$-14 \pm 45 \phi$
	Castor angle	$4^{\circ} 57 \pm 45 \phi$
	Toe-in angle (total toe-in)	$8 \pm 12 \phi$
	King pin inclination	$12^{\circ} 45 \pm 45 \phi$
Rear	Camber angle	$-60 \pm 45 \phi$
	Toe-in angle (total toe-in)	$12 \pm 12 \phi$

Wheels and Tyres

Wheel size	6.5J×17	7.5J×18
Tyre size	215/60 R17 96H	235/50 R18 97W

Tyre Pressure (Cold)

Wheels	Unladen
Front	250kPa/2.5bar/37psi
Rear	210kPa/2.1bar/31psi

Appendix

338 *Removable Tow Bar*

APPENDIX

Removable Tow Bar

Tow Bar Operating Instructions

Safety:

Operation of the detachable tow bar should only be performed by hand, never use hand tools to operate the locking mechanism.

If the trailer is fitted with a security cable or brake cable it must be attached to the dedicated connection hole in the fixed part of the tow bar.

When a stabiliser coupling is installed on the trailer never use grease on the tow ball.

Always remove the detachable tow ball when not in use if it obscures the registration plate.

Preparation:

Remove tow ball cover.

Ensure the tow ball is clean and free from dirt and debris.

Ensure the tow ball is in the 'spring position' (see picture 3.1).

The tow ball is in the spring position if:

- The operating handle is pushed in completely and no colour indication is shown inside the indication area of the operating handle.
- The slider is pulled fully towards the tow ball (shown in picture 3.1).
- It is not possible to lock the system with the supplied locking keys (see picture 5.2).

The tow ball is NOT in the spring position if:

- The operating handle is popped out and shows a red field in the indication area of the operating handle (see picture 3.1)
- The slider is pushed out towards the tow ball (the part is indicated by in picture 3.1).
- It is possible to lock the system with the supplied keys (see picture 5.2).

To place the tow ball in the spring position:

- Unlock the tow ball (see picture 6.1)
- Push the operating handle inwards, rotate in a clockwise direction (whilst pushing inwards) until the handle remains in position (see picture 3.2). If unsure repeat operation.

Note: If a tow ball cannot be tensioned into the spring position it cannot and **MUST NOT** be used.

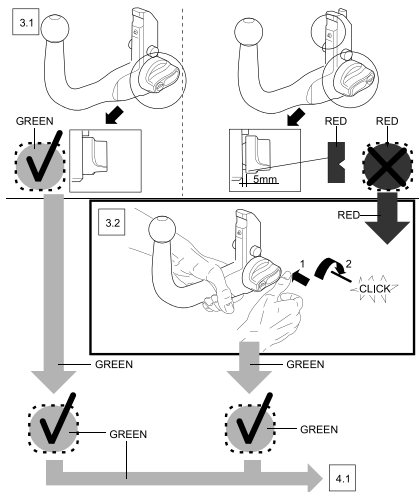

Attachment:

Before attaching the tow ball to the car please remove the cover from the housing (see picture 4.1).

- Insert tow ball (that must be in the spring position) fully into the housing.
- Hold the tow ball in position, keeping your hands away from the operating handle, use a slight force to pull at the tow ball as shown in picture 4.3.
- The unlocking pin will trigger the locking mechanism and the locking process will automatically take place.
- Always check the tow ball is correctly installed, this can be recognised by:
 - The operating handle pops out and an approximate gap of 5 millimeters will be visible between the tow ball and the operating handle (see picture 5.1).
 - A green field will be visible in the indication area of the operating handle (see picture 5.1).
- The tow ball can be locked using the supplied keys (see picture 5.2). This can only be done when the handle has popped out completely, after this the handle can no longer be pushed in and the tow ball cannot be released (remember to remove the keys).

APPENDIX

- Check the tow ball for security – no play should be evident.

The tow ball is now ready for use.

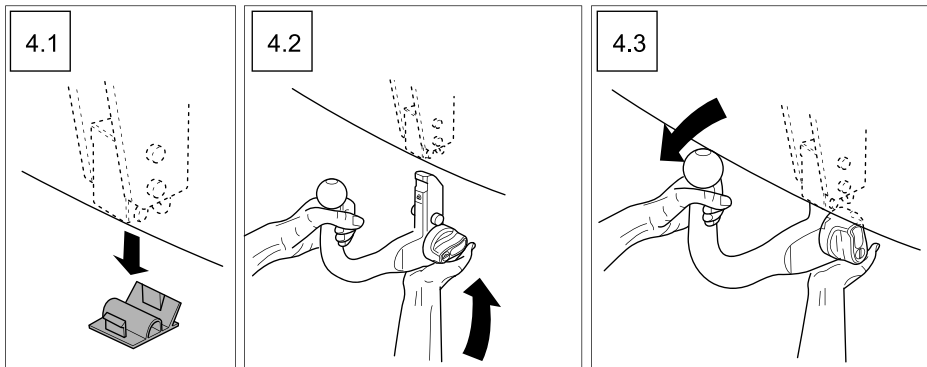

Care Points

- Always check the tow ball for correct mounting every time prior to use.
- Never attempt to attach/detach a tow ball whilst trailer/accessory attached.
- Always keep the tow ball clean and free from debris, do not clean with high pressure washer.
- Never use a tow ball that has signs of damage, excessive wear or modification.
- Never use a tow ball that has been installed by any other method than 'hand pressure'.

Removal

Always disconnect the trailer/accessory and safety cable prior to tow ball removal.

- Unlock the detachable tow ball by turning the locking key clockwise using your thumb and forefinger (see picture 6.1).
- Hold the tow ball with your left hand, push the operating handle fully inwards and turn clockwise until the operating handle remains in position (see picture 6.3).

- The tow ball can now be removed from the housing in a downward motion (see picture 6.4). **WARNING**, this item is heavy, do not allow it to drop.
- Refit the plastic cover into the housing (see picture 6.5).

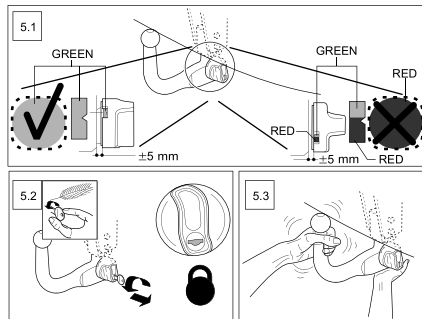

APPENDIX

