



MG GS Owners Handbook

Preface	1
Introduction	1
The Owner's Handbook	1
Status at Time of Printing	1
Symbols Used	1
In an Emergency.....	2
Vehicle Identification Information	3
Vehicle Identification	3
Vehicle Identification Label	4
I Instruments and Controls	5
Instruments and Controls	6
Instrument Pack	8
Tachometer	8
Engine Coolant Temperature Gauge	8
Fuel Gauge.....	9
Speedometer.....	9
Message Centre	10
Digital Clock	10

CONTENTS

Engine Coolant Temperature Gauge and Fuel Gauge	10
Trip I.....	10
Gear Display.....	11
Odometer.....	11
Vehicle Information Display	11
Warning Lights and Indicators.....	22
Lights and Switches.....	32
Master Light Switch.....	32
Instrument Pack Illumination Adjustment.....	34
Headlamp Levelling Manual Adjustment*	34
Headlamp Levelling Automatic Adjustment*	35
Fog Lamps Switch	35
Direction Indicator/Main Beam Switch.....	36
Hazard Warning Lamps	37
Wipers and Washers.....	38
Front Windscreen Wiper Controls	38
Programmed Wash/Wipe	40
Rear Windscreen Wiper Controls.....	40
Steering System	42

Adjustment of Steering Column.....	42
Electric Power Assisted Steering	43
Horn.....	44
Rearview Mirrors.....	45
Exterior Rearview Mirrors	45
Interior Rearview Mirror	47
Sunvisor	49
Windows.....	50
Power Operated Window Switch	50
Window Operation.....	50
Interior Light	53
Front Courtesy and Map Reading Lights	53
Rear Courtesy Light.....	54
Power Socket	55
Front Console Power Socket.....	55
Rear Loadspace Power Socket *	56
Storage Devices	57
Instructions	57

CONTENTS

Glove Box.....	57
Storage Box – Centre.....	58
Storage Box – Driver Side.....	58
Cubby Box.....	59
Cup Holder	60
Centre Console Cup Holder	60
Rear Armrest and Rear Cup Holder.....	60
Roof Luggage Rack *	61
Maximum Authorised Load for the Roof.....	61
Periodical Check.....	61
2 Air Conditioning and Audio Systems	63
Ventilation	64
Particle/Pollen Filter	65
Vents	65
Manual Temperature Control *	67
Control Panel.....	67
Blower Speed Control.....	67
Temperature Control.....	67

A/C On/Off	67
Air Distribution Mode	68
Heated Rear Window	69
Air Circulation Mode	69
Automatic Temperature Control *	70
Control Panel	70
Air Conditioning System Display	71
Air Distribution Mode	72
Temperature Control	72
Automatic Temperature Control Mode	72
A/C On/Off	73
Blower Speed	73
Defrost/Demist	74
Heated Rear Window	74
Air Circulation Mode	75
System On/Off	75
Radio	76
Instructions	76
Radio Control Panel	77

CONTENTS

Basic Operation.....	78
EQ Setting.....	79
Radio Function.....	80
USB/AUX.....	82
MENU Setting.....	84
Entertainment System *	85
Important Safety Information.....	85
Cautions for Using Screen.....	86
Playable File Format for Entertainment System.....	87
Basic Operations.....	89
Bluetooth Phone.....	98
Entertainment.....	113
Air Conditioning - A/C.....	132
Vehicle-Mobile Phone Interconnection (MirrorLink).....	132
Vehicle Setting.....	134
Settings.....	136
3 Seats & Restraints.....	147
Seats.....	148
Overview.....	148

Head Restraints.....	148
Manual Seat Adjustment *	150
Power Seat Adjustment *	151
Front Seat Heating *	151
Rear Seats.....	153
Seat Belts	154
Protection Provided by Seat Belts	155
Wearing Seat Belts.....	156
Seat Belt Pre-tensioners.....	160
Seat Belt Checks, Maintenance and Replacement.....	162
Airbag Supplementary Restraint System	164
Overview	164
Airbag Deployment	166
Conditions in Which Airbags Will Not Deploy	169
Disabling the Passenger Airbag.....	170
Service and Replacement of Airbags.....	171
Disposal of Airbags	172
Child Restraints	173
Important Safety Instructions about Using Child Restraints	173

CONTENTS

Child Restraints Groups.....	176
Approved Child Restraint Positions	179
4 Starting & Driving	185
Keys	186
Introduction	186
Replacing the Battery *	187
Child Proof Locks	189
Alarm Systems	190
Engine Immobilisation	190
Electronic Antitheft Alarm System	191
Tailgate.....	194
Starting and Stopping Engine	196
Ignition Switch	196
Starting the Engine.....	197
Stopping the Engine.....	199
Economical and Environmental Driving	201
Running-in.....	201
Environment Protection	201

Driving Style.....	201
Fuel Saving and Extending Vehicle Life	202
Maintenance	204
Catalytic Converter	205
Fuel System.....	207
Fuel Requirements.....	207
Fuel Filler	208
Refueling.....	208
6-Speed Manual Transmission *	209
Twin-clutch Sportronic Transmission (TST) *	211
Instructions	211
Gear Shift.....	211
Vehicle Start-off.....	214
Driving on Hills	215
Control Mode	216
Protection Mode	219
Brake System.....	221
Foot Brake.....	221
Anti-lock Brake System (ABS)	226

CONTENTS

Electronic Parking Brake (EPB).....	227
Stability Control System (SCS) and Traction Control System (TCS).....	231
Tyre Pressure Monitoring System (TPMS) *	233
Stop/Start —Intelligent Fuel Saving System	235
Automatic Shutdown of Engine	236
Engine Auto Stop Conditions	236
Stop/Start Prohibited	236
Automatic Engine Start	237
Start Inhibition.....	237
Stall Assist.....	238
Battery.....	238
Stop/Start Intelligent Fuel Saving System Failure	239
Starter Inoperative, Serious Battery Capacity Loss	239
Cruise Control System	240
Active Speed Limit (ASL) System.....	243
Activate	243
Kick Down	244
Suspending ASL	244
Resuming ASL.....	244

Overshoot of Target Speed and Warning	244
Parking Aid *	246
Ultrasonic Sensor Parking Aid	246
Parking Camera	248
Parking Aid Information	248
Load Carrying	250
Load Space.....	250
Internal Loading.....	251
General Towing Safety	251
5 Emergency Information	253
Hazard Warning Devices	254
Hazard Warning Lights	254
Warning Triangle.....	254
Emergency Starting	255
Using Booster Cables	255
Starting the Vehicle.....	255
Vehicle Recovery	257
Towing for Recovery.....	257

CONTENTS

Transporter or Trailer with Rope	260
Tyre Repair and Wheel Replacement	261
Tool Identification *	261
Tyre Repair *	261
Spare Wheel and Tool Kit *	265
Changing a Wheel *	266
Fuse Replacement	270
Fuse	270
Battery Fuse Box	271
Passenger Compartment Fuse Box	272
Engine Compartment Fuse Box	275
Bulb Replacement	279
Bulb Specification	279
Replacing Bulbs	280
6 Maintenance	283
Maintenance	284
Routine Servicing	284
Bonnet	288

Opening the Bonnet	288
Closing the Bonnet.....	288
Bonnet Open Alarm.....	288
Engine Compartment	290
Engine	291
Engine Oil	291
Engine Oil Level Check and Top Up.....	292
Engine Oil Specification.....	293
Cooling System.....	294
Coolant Check and Top Up	294
Coolant Specification	295
Brake.....	296
Brake Pads	296
Brake Fluid Check and Top Up.....	296
Brake Fluid Specification	297
Battery.....	298
Battery Maintenance	298
Battery Replacement.....	299
Washer	300

CONTENTS

Washer Fluid Check and Top Up	300
Washer Nozzles	301
Washer Fluid Specification	301
Wipers	302
Wiper Blades	302
Replacing Wiper Blades.....	303
Tyre	304
Outline	304
Caring for Your Tyres	305
Tyre Wear Indicators	306
Replacement of Tyres	307
Wheel Fitment Rotation	307
Tyre/Snow Chains	308
Cleaning and Vehicle Care.....	309
Washing Your Car	309
Cleaning the Interior.....	311
7 Technical Data	313
Technical Data Dimensions	314

CONTENTS

Weights	315
Towing Weights.....	315
Major Parameters of Engine	316
Recommended Fluids and Capacities	317
Wheel Alignment (Unladen Condition)	318
Wheels and Tyres	318
Tyre Pressures(Cold)	318

Introduction

The Owner's Handbook

This handbook describes all of the vehicles and standard equipment specification within the model range. Some of the information therefore, may not apply to your particular car.

Always remember that if you have any queries concerning the operation or specification of your car, your MG Authorised Repairer will be glad to advise you.

Status at Time of Printing

MG operates a policy of constant product improvement and therefore reserves the right to change specifications without notice at any time. Whilst every effort is made to ensure complete accuracy of the information in this publication, no liabilities for inaccuracies or the consequences thereof, including loss or damage to property, or injury to persons, can be accepted by the manufacturer or MG Authorised Repairer who supplied the publication, except in respect of personal injury caused by the negligence of the manufacturer or MG Authorised Repairer.

Symbols Used

The following symbols used within the handbook call your attention to specific types of information.

Warning



This warning symbol identifies procedures that must be followed precisely, or information that must be considered with great care, in order to reduce the risk of personal injury or serious damage to the car.

Important

IMPORTANT
The statements stated here must be followed strictly, otherwise your car could be damaged.

Note

Note: *This describes helpful information.*

PREFACE



This symbol indicates parts described must be disposed of by authorised persons or bodies to protect the environment.

Asterisk

An asterisk (*) appearing within the text, identifies features or items of equipment that are either optional, or are only fitted to some vehicles in the model range.

Illustration Information



Identifies components being explained.



Identifies movement of components being explained.

In an Emergency

IMPORTANT

Remember the breakdown safety code

If a breakdown occurs while travelling:

- Wherever possible, consistent with road safety and traffic conditions, the car should be moved off the main thoroughfare, preferably into a lay-by. If a breakdown occurs on a motorway, pull well over to the inside of the hard shoulder.
- Switch on hazard lights.
- If available, position a warning triangle or a flashing amber light 150 to 500 ft behind your vehicle to warn approaching traffic. Note it is a legal requirement of some countries that a warning triangle is carried in the vehicle, if in doubt consult the local highways agency for further information.
- Consider evacuating passengers through nearside doors onto the verge as a precaution in case your vehicle is accidentally struck by other traffic.

Vehicle Identification Information

Vehicle Identification

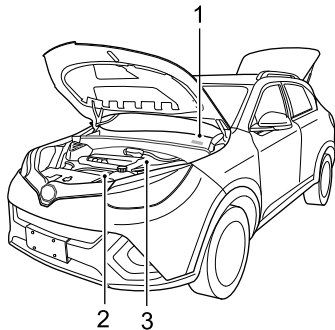

- 1 Vehicle Identification Number (VIN)
- 2 Engine Number
- 3 Transmission Number

Always quote the Vehicle Identification Number (VIN) when communicating with your MG Authorised Repairer.

Vehicle Identification Location

VIN Location

- Stamped on a plate visible through the bottom left hand corner of the windscreen.
- On the identification plate.
- On the floor under the right front seat.

Engine Number Location

Stamped on the front - right of the cylinder block. (View from the front of the engine)

Transmission Number Location

On a label attached to the upper face of the transmission housing. The transmission number of some vehicles is on the right transmission housing (viewed from the front vehicle), which can be seen when the vehicle is lifted. Please contact an MG Authorised Repairer.

PREFACE

Vehicle Identification Label

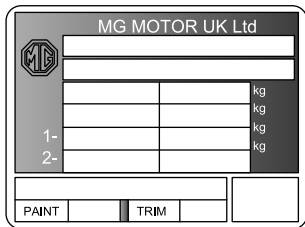

The vehicle identification label contains the following information.

- Type Approval Number
- Vehicle Identification Number (VIN)
- Gross Vehicle Weight
- Gross Train Weight
- Max Front Axle Weight
- Max Rear Axle Weight
- Paint Code
- Blank
- Trim Code

Location of Vehicle Identification Label

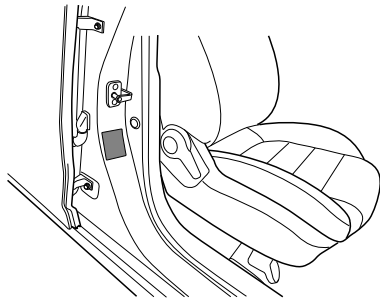

The identification label is located the right side pillar B.

Instruments and Controls

- | | | | |
|----|--------------------------------------|----|----------------------------|
| 6 | <i>Instruments and Controls</i> | 57 | <i>Storage Devices</i> |
| 8 | <i>Instrument Pack</i> | 60 | <i>Cup Holder</i> |
| 10 | <i>Message Centre</i> | 61 | <i>Roof Luggage Rack *</i> |
| 22 | <i>Warning Lights and Indicators</i> | | |
| 32 | <i>Lights and Switches</i> | | |
| 38 | <i>Wipers and Washers</i> | | |
| 42 | <i>Steering System</i> | | |
| 44 | <i>Horn</i> | | |
| 45 | <i>Rearview Mirrors</i> | | |
| 49 | <i>Sunvisor</i> | | |
| 50 | <i>Windows</i> | | |
| 53 | <i>Interior Light</i> | | |
| 55 | <i>Power Socket</i> | | |

INSTRUMENTS AND CONTROLS

Instruments and Controls

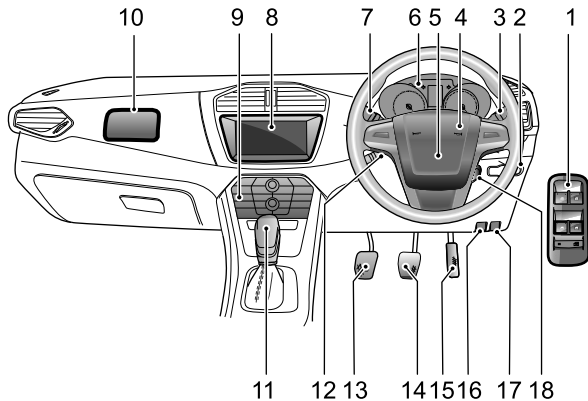

INSTRUMENTS AND CONTROLS

- 1 Power Window Switch
- 2 Exterior Rearview Mirrors and Master Lighting Switch
- 3 Wiper/Washer Controls
- 4 Horn Button
- 5 Driver Airbag
- 6 Instrument Pack
- 7 Indicator and Main Beam Stalk Switch
- 8 Onboard Entertainment System
- 9 Entertainment/Air Conditioning Controls *
- 10 Front Passenger Airbag
- 11 Gear Shift Lever
- 12 Cruise Stalk Switch *
- 13 Clutch Pedal *
- 14 Brake Pedal
- 15 Accelerator Pedal
- 16 Bonnet Release Handle
- 17 Fuel Filler Flap Release Handle
- 18 Ignition Switch

INSTRUMENTS AND CONTROLS

Instrument Pack

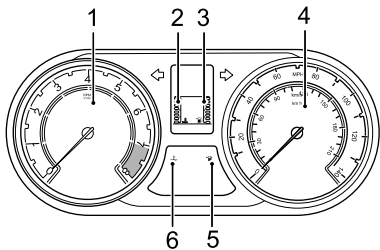

Tachometer

Indicates the engine speed (figure 1), in $\times 1000$ rpm.

IMPORTANT

To protect the engine from damage, never allow the pointer to remain in the red sector of the gauge for prolonged periods.

Engine Coolant Temperature Gauge

The engine coolant temperature is indicated by the number of segments illuminated. There are 8 segments in total (figure 2).

During normal engine temperature operating conditions segments 1 - 6 are illuminated. If segment 7 illuminates it will cause the coolant temperature warning lamp (figure 6) to illuminate and **Engine Temp High** will be displayed in the message centre vehicle information display. If the temperature continues to rise and segment 8 is illuminated the coolant temperature warning light (figure 6) will flash accompanied by **Engine Temp High** being displayed in the message centre vehicle information display.

High engine coolant temperature could result in severe damage. Stop the vehicle and switch off the engine as soon as safety permits and seek an MG Authorised Repairer at the earliest opportunity.

If the engine coolant temperature sensor malfunctions, all 8 segments will extinguish and the high temperature warning indicator lamp (figure 6) will flash with the

message **Temperature Sensor Fail** appearing in the message centre vehicle information display.

Fuel Gauge

The quantity of fuel in the tank is indicated by the number of segments illuminated (figure 3). There are 8 segments in total. When only one segment remains illuminated, the low fuel warning indicator (figure 5) below the message centre illuminates, with the message **Low Fuel** appearing in the message centre vehicle information display. If the fuel continues to fall to a critical state, the low fuel lamp (figure 5) will flash along with the 1st segment. The **Low Fuel** message will appear in the message centre vehicle information display and an audible warning will sound.

IMPORTANT

If the low fuel warning lamp indicator illuminates, refuel at the earliest opportunity.

If the instrument pack detects an out-of-range fuel sender value when the ignition is in position II, the bottom fuel segment will flash along with the low fuel warning lamp (figure 5), the message **Fuel Sensor Fail** will

appear in the message centre vehicle information display accompanied by an audible warning.

An arrow next to the low fuel warning lamp (figure 5) indicates that the fuel filler is located on the left hand side of the car.

Speedometer

Indicates the vehicle speed (figure 4) in MPH and km/h.

INSTRUMENTS AND CONTROLS

Message Centre

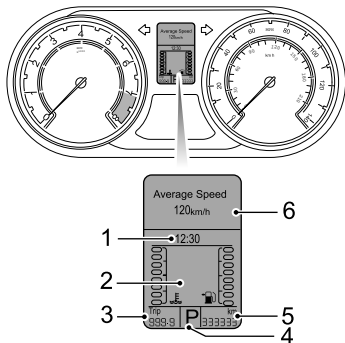

The message centre display is in the centre of the instrument pack. It provides the following information:

- 1 Digital clock
- 2 Engine coolant temperature gauge and fuel gauge
- 3 Trip I

4 Gear display

5 Odometer

6 Vehicle information display

Digital Clock

Displays the current time in digital form.

Engine Coolant Temperature Gauge and Fuel Gauge

Refer to "Engine Coolant Temperature Gauge" and "Fuel Gauge" of this section.

When Active Speed Limit (ASL) is activated, this area will also display the set speed. For setting of the ASL system, refer to "Active Speed Limit" in the "Starting and Driving" section.

Trip I

When the ignition is in position II, the current driven mileage since last reset is displayed. To reset Trip I, refer to "Function Reset" in "Main Menu" of this section.

Gear Display

With the ignition in position II, the current gear position will be displayed.

- Automatic: P, R, N, D, I, 2, 3, 4, 5, 6, 7, W or S
- Manual: N, R, I, 2, 3, 4, 5 or 6

If 'EP' is displayed it indicates a fault with the automatic transmission.

When a gear change is advised, an up or down arrow will be displayed above the gear position.

Odometer

When the ignition is in position II it displays the total distance the car has travelled.

Vehicle Information Display

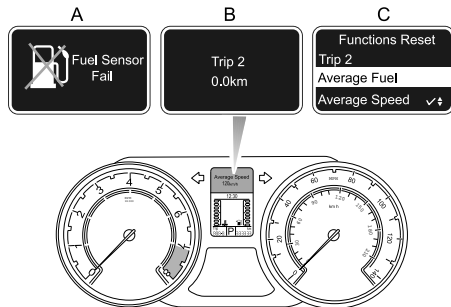

The vehicle information display contains the following information:

- 1 Warning information (figure A)
- 2 Trip computer menu (figure B)
- 3 Menu (figure C)

INSTRUMENTS AND CONTROLS

Warning Information

The vehicle information display uses two methods to convey warning information to the driver. These are :

- A message accompanied by a symbol
- A view of the vehicle with an open door, bonnet or boot/tailgate

Some warning messages are re-enforced by an audible warning.





Warning Messages and Symbols

Two types of warning messages are displayed :



- Messages re-enforced by a red or yellow symbol and the illumination of a warning light.
- Messages supported by a red or yellow symbol only.





When a fault is detected, the appropriate warning message together with a symbol will appear in the display. The message will disappear after a few seconds. If the warning is not supported by a warning light, some symbols will continue to display as static icons until the fault is rectified.

The following messages appear in the message centre but are not supported by dedicated warning lights.





Icon	Message	Action
	Close Driver Door	Indicates the need to close the driver's door to enable the engine to restart.
	Fasten Seat Belt	Indicates the need to fasten the driver's seat belt.
	Use Key to Start	Indicates that a key restart is required.
	Stop Start Off	Indicates that Stop/Start Intelligent System is off.
	Stop Start On	Indicates that Stop/Start Intelligent System is on.





INSTRUMENTS AND CONTROLS

Icon	Message	Action
	Please Press Brake	Requesting the driver to press brake pedal.
	Press Brake to Shift	Requesting the driver to press brake pedal to shift gear.
	Press Brake Release EPB	Requesting the driver to press brake to release EPB.
	Select Neutral to Restart	Requesting the driver to put the shift lever of automatic transmission in N position.
	Please Engage Park	Requesting the driver to put the shift lever of automatic transmission in P position during parking



Icon	Message	Action
	Hill Hold Unavailable	Indicating hill hold is currently unavailable.
	Park Brake Force not Enough	Consult MG Authorised Repairer at the earliest opportunity.
	/	Indicating to close all doors, bonnet and boot before leaving or driving the car.
	Please Take Your Key	Indicating to the driver that the key is still in the car, please remove the key.





INSTRUMENTS AND CONTROLS

Icon	Message	Action
	Head Lamp Control Fault	Indicating that the AFS system has a fault.
	Lamp Fail: XXX	Indicating to the driver that the bulb of brake lamp, direction indicator, dipped beam, sidelight, rear fog, reverse lamp has failed. Replace at the earliest opportunity.
	Sidelights On	Information.
	Lights On	Switch the lights off before leaving the car.
	Front Fog Lamps On	Information.
	Rear Fog Lamps On	Information.

Icon	Message	Action
	Washer Fluid Low	Indicating to the driver to check and refill the windshield and headlamp washer fluid.
	Fuel system Fault	Consult MG Authorised Repairer at the earliest opportunity.
	Please Replace Battery	Indicating to the driver that the battery has a failure and needs to be replaced.
	Increase Speed or Stop Safely	Indicating to the driver that the transmission is too hot. Please speed up or park safely under permitted conditions.

INSTRUMENTS AND CONTROLS

Icon	Message	Action
	Stop Safely	Indicating to the driver that the transmission is too hot. Please park safely under permitted conditions.
	Please Wait	Indicating to the driver that the transmission is cooling down, please wait for transmission cooling under permitted conditions. If the warning message still remains on after transmission cooling (appr. 20 mins), please consult MG Authorised Repairer at the earliest opportunity.

Icon	Message	Action
	Ready for Drive Away	Indicating to the driver that the transmission temperature is reduced and the car can continue to drive.
	Slow Down	Indicating to the driver that the selected speed or ASL set point has been exceeded.
	Engage P or N gear to start	Requesting the driver to put into the designated position.
	Please Initialize Driver Window	Requesting the driver to initialize driver's window lift. Please refer to "Windows Control" in this section.

INSTRUMENTS AND CONTROLS

Icon	Message	Action
	Speed Limiter Active	Indicating to the driver that ASL system is active.
	Speed Limiter Inactive	Indicating to the driver that ASL system is inactive.
	Speed Limiter Fault	Indicating to the driver that ASL system has a fault.
	Press SET to Activate	Requesting the driver to push SET button to activate ASL.

Door, Bonnet, Boot Open Indicator

If any door or bonnet or boot is opened when the ignition is switched on, a plan and (or) side view of the car will be displayed. If, however, one or more doors, or the bonnet are not closed when vehicle speed exceeds 3MPH (5km/h), this warning will be repeated in the display.

Trip Computer

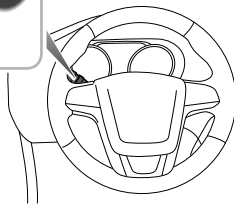
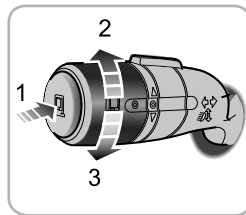

When the ignition is in position II, the different trip computer functions can be selected as follows:

- Rotate the overturn wheel (figure 2, 3) up or down to select the items displaying on trip computer.
- Long press the trip computer button (figure 1) at the end of the lever to reset the items selected ("Average

fuel", "Average Speed", "Trip 2" and "Current Journey").

Note: *If a warning message is received while the trip computer is in use, the trip display will be replaced by the warning message. After a warning has been given, if there are any static warnings then they are displayed. From here the user can navigate back to the trip computer using the UP/DOWN trip switch. If no static warning exists then the display will revert to that prior to the warning.*

The following information will be displayed:

- 1 Digital Speed
- 2 Average Fuel
- 3 Fuel Consumption
- 4 Range to Empty
- 5 Average Speed
- 6 Trip 2
- 7 Current Journey
- 8 Last Journey

Digital Speed

Displays the current vehicle speed.

Average Fuel

Average fuel consumption is calculated by dividing the amount of fuel used by the distance travelled since last reset. The consumption value can be reset at any time to begin calculating new consumption values for a particular journey or driving conditions.

Note: *Average fuel consumption is related to driving habits, road condition, load, tyre pressure, the quality of oil, etc.*

Fuel Consumption

This function is automatic and indicates the instantaneous fuel consumption.

Range to Empty

This function is automatic and displays the remaining distance you can travel before the fuel gauge reads empty. The distance will change when the vehicle is refuelled.

INSTRUMENTS AND CONTROLS

The 'range to empty' calculation is based on a combination of current driving style and the fuel consumption recorded by the computer during the previous few minutes.

Average Speed

Displays the average vehicle speed. Long press the trip computer button at the end of the lever to reset average speed.

Trip 2

Displays the driven distance since the last reset. Long press the trip computer button at the end of the lever to reset trip 2.

Current Journey

Displays the duration, accumulated fuel consumption and distance of current trip since the last journey. Long press the trip computer button at the end of the lever to reset current trip.

Last Journey

Displays the duration, accumulated fuel consumption and distance of previous journey. It can be reset through "Function Reset" in main menu.

Next Service

When the ignition is switched to position II, the vehicle information display will show the estimated date of the next service and the distance remaining until service is required. This is displayed for 3 seconds. Whichever is sooner, the relevant maintenance should be carried out by, and interval announcement reset by, an MG Authorised Repairer.

Note: Because the service interval display reduces in increments of 25 miles, it is possible to undertake a short journey without triggering any movement from the display.

Note: If a service is not carried out (or the display is not reset by an MG Authorised Repairer after servicing) after the distance display shows 0, the distance indicator, having reached zero, will remain at 0 until it is reset.

Menu

Press the trip computer button at the end of the indicator/main beam stalk to enter "Menu" interface.

Rotate the overturn wheel up or down to select the required menu option. Press the trip computer button to enter the sub-menu of this menu option, or execute the function of this menu option after the option is highlighted.

"Menu" provides the following options:

- Esc
- Speed Threshold
- Next Service
- Functions Reset
- TPMS Reset *
- Display Setting

Speed Threshold

This menu displays the current vehicle speed setting value and **+**, **-** symbols. Rotate the overturn wheel up or down to modify the setting speed as required, set the speed range to 20 - 140 mph, and adjust it in the increment of increments of 5 mph or 5 km/h.

After the overspeed alarm is set, if the vehicle speed exceeds the set speed, the message centre displays **Slow Down** accompanied with an audible alarm to alert the driver.

The overspeed can be set to **Off**. The default setting for the overspeed alarm is off.

Next Service *

Shows the estimated date and distance remaining before the next service .

Select **Reset** to reset the maintenance message, long press the trip computer button at the end of the lever until the driving distance displayed in the message centre is reset to the initial value.

Function Reset

Reset **Trip 1, Trip 2, Average Fuel, Average Speed, Current Journey, Last Journey**. To reset all trip computer messages, select **All** and press the trip computer button at the end of the lever.

INSTRUMENTS AND CONTROLS

TPMS Reset *

Select **TPMS Reset** menu, and press the trip computer button at the end of the lever to initialize the system. If successful, the message centre will display **TPMS Reset OK**. If unsuccessful, the message centre will display **TPMS Reset Fail**, consult your MG Authorised Repairer.

Note: *TPMS will need to be reset every time the tyres are replaced or the pressures are changed.*

Note: *The TPMS reset menu will only be available when the car is stationary, with the parking brake applied and ignition in position II.*

Display Setting

Some vehicle functions can be set in this menu, including **Units, Trip Computer, Illumination Colour, Illumination Level.**

Units

Set the units of fuel consumption and distance.

Consumption

Select either **L/100 km, km/L, mpg (US) or mpg (UK).**

Distance

Select **Miles** or **km.**

Trip Computer

Select **Default Mode** or **Function Selection.**

Default Mode

Select **Blank** or **History.**

Function Selection

Select **Digital Speed, Average Fuel, Instantaneous Fuel, Range to Empty, Average Speed, Trip 2, Current Journey** and **Last Journey.**

Illumination Colour

Set the illumination color of instrument pack. Select **Red, White** or **Sport Mode** as required.

Illumination Level

Displays the current backlight brightness and +, - symbols.
Rotate the overturn wheel up or down to adjust backlight brightness. There are 3 brightness levels in total.

INSTRUMENTS AND CONTROLS

Warning Lights and Indicators

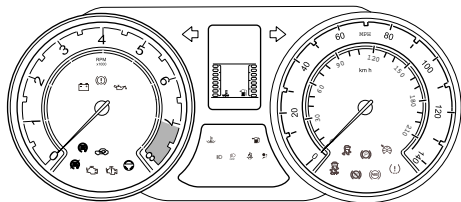

Warning lights and indicators are mostly located below the tachometer, speedometer and message centre.

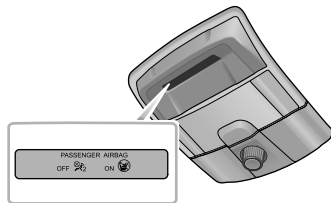

Front passenger airbag ON/OFF indicator lamps are located on the auxiliary display module, located on the front interior lamp and reading lamp.

Main Beam Indicator - Blue



With the ignition switch in position II, this lamp illuminates to conduct a system self-check and extinguishes upon the completion. With the headlamp high beams turned on, this lamp illuminates, and the message centre displays **Main Beam On**.

Note: *After high beam is activated for more than 2 seconds, the message centre will display Main Beam On.*

Dipped Beam Off - Yellow



With the ignition switch in position II, this lamp illuminates to conduct a system self-check and extinguishes upon the completion. If this lamp does not extinguish or illuminates during driving, it indicates to the driver that the dipped beam lamps are switched off and that it is necessary to turn them on. The indicator flashes first and then remains on after 90 seconds or until the driver switches the dipped beam lamps on.

Direction Indicators - Green



With the ignition switch in position II, this lamp illuminates to conduct a system self-check and extinguishes upon the completion. The left and right direction indicator lamps are indicated by directional arrows, which are located at the top of the instrument pack. When the turning signal lamp flashes, the direction indicator lamp on the corresponding side also flashes. If the hazard warning lamps are operated, both direction indicator lamps will flash together. If either direction indicator lamp in the instrument pack flashes very rapidly, it indicates the turning signal lamp on the corresponding side has failure.

Note: *Failure of a side repeater lamp will have no effect on the flash frequency of direction indicator lamp.*

Airbag Warning - Red



With the ignition switch in position II, this lamp illuminates to conduct a system self-check and extinguishes

INSTRUMENTS AND CONTROLS

upon the completion. If this lamp does not extinguish or illuminates during driving, it indicates a SRS fault or seat belt pre-tensioner fault has been detected. After the vehicle is started, the message centre will display **Airbag Fault** and issue an acoustic warning. Seek an MG Authorised Repairer urgently. An SRS fault may mean that components may not be deployed in the event of an accident.

If the lamp fails, the message centre will display **Airbag Lamp Fail**.

Seat Belt Unfastened Warning - Red



With the ignition switch in position II, this lamp illuminates to conduct a system self-check and extinguishes upon the completion. If this lamp does not extinguish, it indicates that the seat belt for an occupied front seat remains unfastened.

When the vehicle speed exceeds 10 mph, 15 km/h and the seat belt for an occupied front seat remains unfastened, this lamp flashes accompanied with an audible warning. The

message centre displays **Fasten Seat Belt** or **Fasten Passenger Seat Belt**.

Cruise Control - Green/Yellow



With the ignition switch in position II, this lamp illuminates green first and then changes into yellow to conduct a system self-check. If the cruise master switch is switched on, but no speed is set this lamp illuminates green. The message centre displays **Cruise Control Standby**.

When the cruise control system operates, this lamp illuminates yellow, indicating the cruise control system is activated. The message centre displays **Cruise Set xxx km/h** or **Cruise Set xxx MPH** (xxx indicates set speed).

If a failure in the cruise control system is detected, when the green indicator extinguishes, the yellow indicator flashes three times, and the message centre displays **Cruise Control Fail** accompanied with an audible warning. Seek an MG Authorised Repairer urgently

Low Oil Pressure Warning - Red



With the ignition switch in position II, the lamp illuminates to conduct a system self-check and extinguishes after the vehicle is started. If the light remains on (accompanied by the message **Low Oil Pressure**), or illuminates continuously when driving, serious engine damage could occur; stop the vehicle as soon as safety permits and **SWITCH OFF THE ENGINE IMMEDIATELY**. Check the oil level. Seek an MG Authorised Repairer urgently.

Alternator Malfunction Warning - Red



With the ignition switch in position II, the lamp illuminates to conduct a system self-check and extinguishes after the vehicle is started. If this lamp does not extinguish after the car is started or illuminates during driving, the message centre displays **Alternator Fail**. Seek an MG Authorised Repairer urgently.

If a severely low battery condition occurs, the system will limit or turn off some electrical devices, in this case, the message centre displays **Power Low: Features May be Limited** or **Power Low: Features May Be Off** accompanied with an audible warning.

Tyre Pressure Monitoring System (TPMS) Warning - Yellow *



With the ignition switch in position II, this lamp illuminates to conduct a system self-check and extinguishes upon the completion. If this lamp does not extinguish or illuminates during driving, it indicates a tyre pressure is low, and the message centre displays **Low Tyre Pressure**, in this case, please check your tyre pressures.

If this lamp flashes and then remains ON for 90 seconds, it indicates the system has a failure, the message centre displays **TPMS Fail**. Seek an MG Authorised Repairer urgently.

INSTRUMENTS AND CONTROLS

Stability Control System/Traction Control Operation and Fault Warning - Yellow



With the ignition switch in position II, this lamp illuminates to conduct a system self-check and extinguishes upon the completion. If this lamp does not extinguish or illuminates during driving, it indicates the system has a failure. After the vehicle is started, the message centre will display **Stability Control Fail** or **Traction Control Fail** accompanied with an audible warning. Please seek an MG Authorised Repairer urgently.

If this lamp flashes during driving, it indicates the system is operating to assist the driver.

Dynamic Stability Control/Traction Control OFF Warning - Yellow



With the ignition switch in position II, this lamp illuminates to conduct a system self-check and extinguishes upon the completion. If the dynamic stability control/traction control system is switched off manually,

this warning lamp will illuminate. After the vehicle is started, the message centre will display **Stability Control Off** or **Traction Control Off** accompanied with an audible warning.

ABS Warning - Yellow



With the ignition switch in position II, this lamp illuminates to conduct a system self-check and extinguishes upon the completion. If this lamp does not extinguish after the car is started, the message centre displays **ABS Fail** accompanied with an audible warning. Please seek an MG Authorised Repairer urgently.

If an ABS failure occurs while driving, ABS operation will be suspended, but normal braking will still be available. Please seek an MG Authorised Repairer urgently.

Brake System Warning - Red



With the ignition switch in position II, this lamp illuminates to conduct a system self-check and extinguishes

upon the completion. If this lamp does not extinguish or illuminates during driving, it indicates a failure with the braking system such as brake fluid loss or electronic brake force distribution failure. The message centre displays **Brake Fail**.

Check brake fluid level (refer to "Check and Refill Brake Fluid" under the "Service and Maintenance" section). If the lamp remains on, stop the car as soon as safety permits and seek an MG Authorised Repairer urgently.

Check Engine/Drive by Wire Warning - Yellow



The indicator lamp is used to indicate any failure detected by the engine management system which seriously affects the engine performance and emissions. With the ignition switch in position II, this lamp illuminates to conduct a system self-check and extinguishes upon the completion.

This lamp will illuminate if an engine fault occurs that will effect engine performance during driving, and the message

centre displays **Check Engine**. Please seek an MG Authorised Repairer urgently.

Engine Emissions Malfunction Warning - Yellow



The indicator lamp is used to indicate any engine failure which will affect the engine performance and emissions. With the ignition switch in position II, the lamp illuminates to conduct a system self-check and extinguishes after the car is started.

This lamp will illuminate if an engine fault occurs that will effect engine performance and emissions during driving, and the message centre displays **Engine Fault**. Seek an MG Authorised Repairer urgently.

Engine Coolant Temperature Warning - Red



With the ignition switch in position II, this lamp illuminates to conduct a system self-check and extinguishes upon the completion. If this lamp does not extinguish or illuminates during driving, the message

INSTRUMENTS AND CONTROLS

centre displays **Engine Temp High** to inform the driver that the engine coolant temperature is high. If the coolant temperature continues to increase, this lamp will flash, accompanied with a repeated audible warning. High engine coolant temperature could result in severe damage. Stop the vehicle and switch off the engine as soon as safety permits and seek an MG Authorised Repairer at the earliest opportunity.

Electric Power Assisted Steering (EPS)/ Steering Angle Sensor (SAS) Warning - Red/Yellow



The warning lamp is used to indicate electric power steering failure or steering angle sensor failure. With the ignition switch in position II, this lamp illuminates yellow first, then changes into red, and extinguishes after a system self-check.

If this lamp illuminates yellow, it indicates the electric power assisted steering system has a general failure and the performance will be reduced. After the car is started, the

message centre displays **Steering Power Reduced** accompanied with an audible warning. As soon as safety permits, stop the car, switch off the engine and restart. If the lamp remains illuminated seek an MG Authorised Repairer urgently.

If this lamp flashes red, it indicates the electric power steering system has a serious fault. After the car is started, the message centre displays **Power Steering Fault** accompanied with an audible warning. Please seek an MG Authorised Repairer urgently.

If this lamp illuminates red, it indicates the steering angle sensor has a fault or is not calibrated. After the car is started, the message centre displays **SAS Fault** or **SAS Uncalibrated See Handbook** accompanied with an audible warning. Please seek an MG Authorised Repairer urgently.

Engine Immobiliser System Warning - Red



With the ignition switch in position II, this lamp illuminates to conduct a system self-check and extinguishes

upon the completion. If the engine immobiliser system verification fails and the engine does not start, the warning lamp will remain on, and the message centre displays **Invalid key**.

If the key battery is low, the lamp flashes and the message centre displays **Key Battery Low**.

If the alarm has been triggered, when the door is opened, the lamp will flash, **Alarm Triggered** will be displayed in the message centre accompanied by an audible warning.

Electronic Parking Brake (EPB) System Malfunction Warning - Yellow



With the ignition switch in position II, this lamp illuminates to conduct a system self-check and extinguishes upon the completion. If electronic parking brake system failure is detected or the system is under diagnosis, the indicator lamp will illuminate accompanied with audible warning.

Stop/Start Energy Saving System Status Indicator - Green



With the ignition switch in position II, this lamp illuminates to conduct a system self-check and extinguishes upon the completion. If the Stop - Start energy saving system is activated, this lamp illuminates to inform the driver that the engine is controlled by the Stop - Start energy saving system, and the message centre displays **Stop Start Active**. When the Stop - Start energy-saving system is currently unavailable, this lamp flashes three times and then extinguishes.

Stop/Start Energy Saving System Malfunction Warning - Yellow



This lamp is used to indicate a fault with the Stop - Start Energy Saving System. With the ignition switch in position II, this lamp illuminates to conduct a system self-check and extinguishes upon the completion. If this lamp does not extinguish or illuminates during driving, the

INSTRUMENTS AND CONTROLS

message centre displays **Stop Start Fault** accompanied with an audible warning.

Low Fuel Warning Lamp - Yellow



With the ignition switch in position II, this lamp illuminates to conduct a system self-check and extinguishes upon the completion. The warning lamp illuminates when the fuel remaining in the fuel tank is low, and the message centre displays **Low Fuel** accompanied with an audible warning. If possible, please refuel before the low fuel warning lamp illuminates.

If the fuel level continues to fall, this lamp flashes, and the message centre displays **Low Fuel** accompanied with an audible warning. When fuel is added to the tank and the fuel level rises above the alert limit, this lamp extinguishes. If it does not extinguish, seek an MG Authorised Repairer urgently.

Note: *When driving on steep or rough roads while the fuel level is low, the warning lamp may illuminate.*

If the instrument pack fails to receive signals from the fuel sensor, this lamp flashes, and the message centre displays **Fuel Sensor Fail** accompanied with an audible warning. Seek an MG Authorised Repairer urgently.

Electronic Parking Brake (EPB)/ Automatic Parking Status Indicator - Red/Green



With the ignition switch in position II, this lamp illuminates green first and then changes into red to conduct a system self-check. After the system self-check, if the lamp illuminates red, it indicates the electronic parking brake is enabled. If this lamp flashes red, it indicates the electronic parking brake clamping force is inadequate, or the electronic parking brake is in the process of dynamic braking.

When the automatic parking system is operating to assist the driver, this lamp illuminates green.

Front Passenger Airbag Off Indicator - Yellow



The indicator is located in the auxiliary display module, it is used to indicate the front passenger airbag is Off. If the front passenger airbag is Off, this indicator will remain on until the airbag is enabled. After the front passenger airbag is enabled, this indicator will be disabled.

Front Passenger Airbag On Indicator - Yellow



The indicator is located in the auxiliary display module, which is used to indicate the front passenger airbag is enabled. If the front passenger airbag is enabled, this indicator will illuminate for one minute after the ignition is switched on, it will then extinguish. After the front passenger airbag is disabled, this indicator will be disabled.

INSTRUMENTS AND CONTROLS

Lights and Switches

Master Light Switch

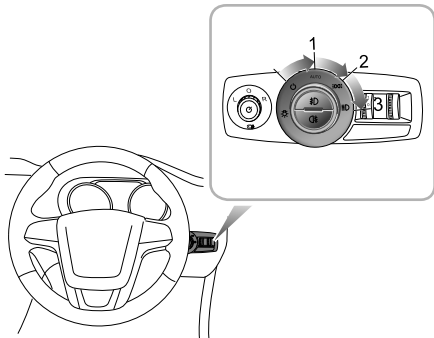

- 1 AUTO Lamp
- 2 Side Lamp/Tail Lamp/Illumination
- 3 Headlamp

AUTO Lamp

With the ignition switch in position ACC, rotate the master lighting switch to position I. The AUTO lighting system will automatically switch the side lamps, tail lamps and instrument pack backlights on and off according to the intensity of current ambient light.

With the ignition switch in position II, rotate the master lighting switch to position I. The AUTO lighting system will automatically switch the side lamps, tail lamps, instrument pack backlights and dipped beam headlamps on and off according to the intensity of current ambient light.

With the master lighting switch in position I and lighting on, the symbols on the switch illuminate green.

Note: This function uses a light sensor that monitors exterior ambient light levels. It is fitted above the instrument panel near the windshield. **DO NOT** mask or cover this area. Failure to adhere to this may result in dipped headlamps operating when not necessary.

Side Lamps, Tail Lamps, Instrument Pack and Switch Illumination

Rotate the master lighting switch to position 2 to switch on the side lamps, tail lamps, instrument pack and switch illumination. The symbols on the switch illuminate green and the information centre will display **Sidelights On** (model dependant). With the ignition switch in the OFF position, if the side lights are on and the driver's door is opened an audible alarm will sound. The information centre will display **Lights On** (model dependant).

Headlamps

When the ignition switch in position II, rotate the master lighting switch to position 3 to switch on the headlamps, dipped beam headlamps and side lamps, the symbols on the switch illuminate green.

Follow Me Home

After the ignition switch is turned off, pull the light lever towards the steering wheel. Follow Me Home function is enabled. The reverse lamps, dipped beam headlamps and rear fog lamps will operate based on your set state and

duration. For specific configuration method of "Follow Me Home", please refer to "Air Conditioning and Audio Systems" section.

Daytime Running Lamp

The daytime running lamps turn on automatically when the ignition switch is in position ACC. When the side lamps are switched on, the daytime running lamps extinguish automatically.

Find My Car *

Press the unlock button on the remote key. The find my car function is enabled. The reverse lamps, dipped beam headlamps and rear fog lamps will operate based on your set state and duration. For specific configuration method of "Find My Car", please refer to "Air Conditioning and Audio Systems" section.

INSTRUMENTS AND CONTROLS

Instrument Pack Illumination Adjustment

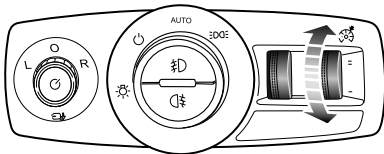

With the ignition switch in position II and master lighting switch in position 2, rotate the thumb-wheel upwards to increase the brightness of the instrument pack illumination, and rotate downwards to decrease the brightness. This thumb-wheel also controls the illumination brightness of switches, information centre and entertainment system displays. With the side lamps turned on, the instrument and entertainment system displays will automatically dim.

Headlamp Levelling Manual Adjustment*

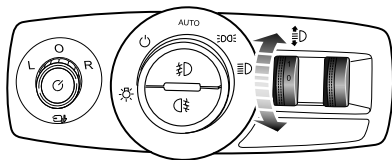

Position 0 is the initial position of the headlamp levelling adjustment switch. The headlamp levelling can be adjusted as per the following table according to the vehicle load.

Location	Load
0	Driver, or driver & front passenger
I	All the seats occupied with no load

Location	Load
2	All the seats occupied plus an evenly distributed load in the boot, or driver with full load
3	Driver only, plus an evenly distributed load in the boot

Headlamp Levelling Automatic Adjustment*

Operating the dipped headlamps whilst the car is in motion allows the range and position of headlamp lights to be automatically adjusted according to the vehicle speed, acceleration and deceleration conditions, uneven road conditions, etc. to enhance the driving safety in the night.

Fog Lamps Switch



Fog lights should only be used when visibility is below 100m - other road users could be dazzled in clear conditions.

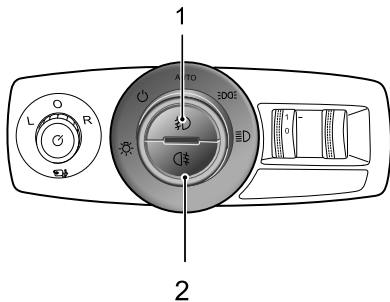

INSTRUMENTS AND CONTROLS

Front Fog Lamps*

With the ignition switch in position II and the side lamps turned on, press the front fog lamp button (1) to operate the front fog lamps. After turning on the front fog lamps, the symbol in the switch illuminates green.

Rear Fog Lamps

With the ignition switch in position II and the headlamps turned on, press the rear fog lamp button (2) to operate the rear fog lamps. After turning on the rear fog lamps, the symbol in the switch illuminates yellow.

Direction Indicator/Main Beam Switch



Take care not to dazzle oncoming vehicles when driving using main beam headlamps.

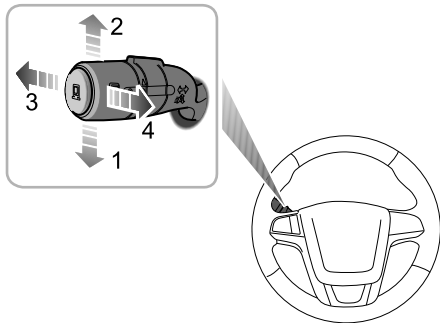

Direction Indicators

Move the lever down to indicate a LEFT turn (1), or up to indicate a RIGHT turn (2). The corresponding GREEN

indicator lamp in the instrument pack will flash when the turning signal lamps are working.

Rotating the steering wheel will cancel the indicator operation (small movements of the steering wheel may not operate the self cancelling). To indicate a lane change, move the lever briefly and release, the indicators will flash three times and then cancel.

Headlamp Main and Dipped Beam

With the ignition switch in position II and the master lighting switch turned to position 3, push the lever (3) towards the instrument panel to operate main beams. The BLUE warning light in the instrument pack illuminates to indicate **Main Beam On** when the headlights are on main beam. Push the light stalk switch (3) once again to switch to dipped beam headlamps.

Headlamp Flash

To briefly flash the main beam on and off, pull the lever towards the steering wheel (4) and then release.

Bulb Failure

Failure of any of the following bulbs will be confirmed by a message and symbol in the message centre.

- Brake Lamps (Only Bulb Type)
- Front Direction Indicators
- Rear Direction Indicators
- Dipped Beam Headlamps
- Position Lamps (Side Lamps, Only Bulb Type)
- Rear Fog Lamps
- Reversing Lamps

Hazard Warning Lamps

Press the hazard warning lamp button  to operate the hazard warning lamps. All direction indicator lamps and direction indicator warning lamps will flash together. Press the button again to switch off. For more details and location refer to 'Emergency Information' 'Hazard Warning Devices'.

INSTRUMENTS AND CONTROLS

Wipers and Washers

Front Windscreen Wiper Controls

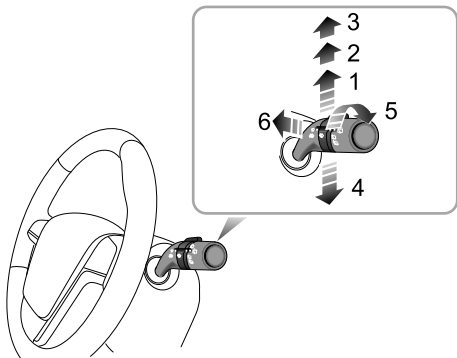

The wipers and washers will only operate when the ignition switch is in position II. Operate the lever to select different wiping speeds:

- Automatic wipe (1) *
- Slow speed wipe (2)

- Fast speed wipe (3)
- Single wipe (4)
- Automatic wipe speed adjustment (5)
- Programmed wash/wipe (6)

Automatic Wipe *

Some models are equipped with a rain sensor fitted to the inside of the windscreen behind the rear view mirror. The sensor is able to detect varying amounts of water on the outside of the windscreen. With the wiper control set to automatic wipe (1), the variable delay will be adjusted automatically according to the information supplied by the rain sensor.

Note: *If the sensor detects constant rain, the wipers will operate continuously. The sensitivity of the sensor can be altered by means of the wiper variable delay (5).*

This speed will also change with the vehicle speed. As the vehicle speed increases, the wiping speed increases. As the vehicle speed decreases, the wiping speed decreases.

Slow Speed Wipe

By pushing the lever up to the slow speed wiping position (2), the wipers will operate slowly. When the vehicle speed decreases to less than 5mph (8km/h), slow wiping will change into automatic wiping. Move the lever to re-select the wiping speed.

Fast Speed Wipe

By pushing the lever up to the fast speed wiping position (3), the wipers will operate at fast speed. When the vehicle speed decreases to less than 5mph (8km/h), fast wipe will change into slow wipe. Move the lever to re-select the wiping speed.

Single Wipe

Pressing the lever (4) down and releasing will operate a single wipe, if the lever is held down, the wipers will operate at high speed until the lever is released.

IMPORTANT

- Avoid operating the wipers on a dry windscreen.
- In freezing or extremely hot conditions, make sure that the wiper blades are not frozen or adhered to the windscreen.
- In winter, remove snow or ice from around the arms and blades, including the wiped area of the screen.

INSTRUMENTS AND CONTROLS

Programmed Wash/Wipe

Pulling the lever toward the steering wheel (6) will operate the windscreen washers. After a short delay, the wipers will commence operating in conjunction with the washers.

Note: *The wipers continue operating for a further three wipes after the lever is released. After several seconds, there will a further wipe to remove any fluid draining down the screen.*

IMPORTANT

If the washers fail to deliver the screen wash solution (dirt or ice may have blocked the jets), release the lever immediately. This will prevent the wipers from operating, and the consequent risk of visibility being impaired by dirt smearing across the unwashed windscreen.

Headlamp Washer *

Cars equipped with HID headlamps feature headlamp washers, these are located in the bumper. After switching on the headlamps, the first use of the screenwashers will initiate a headlamp wash twice. After this, every

fifth screenwash will result in a double headlamp wash operation.

Rear Windscreen Wiper Controls

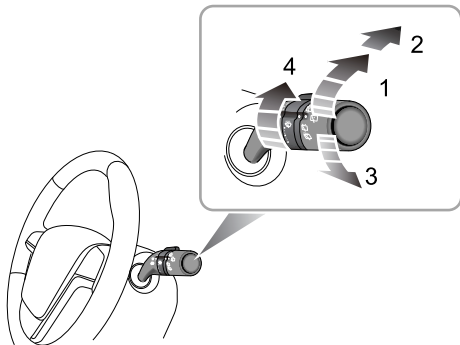

- Intermittent wipe (1)
- Wash and wipe (2)
- Wash and wipe (3)
- Wiper delay switch (4)

The rear washer and wiper will work with the ignition switched to positions I and II. It will become isolated during cranking. If the rear wiper switch is turned to intermittent wipe (1), the rear wiper will operate. It will complete 3 continuous wipes before changing to intermittent mode. The time period between the wipes can be increased/decreased via the wiper delay switch (4). Intermittent wiper speed will vary according to road speed.

If the rear wipe and wash (2) is selected, the rear wiper and washer will operate together, and the rear wiper will move fast. If the switch is released to intermittent wipe (1), the rear washer will stop operating.

If the rear wipe and wash (3) is selected, the rear wiper and washer will operate together. If the switch is released to off position, the rear wiper and washer stop operating.

Note: When the tail gate is opened, rear wiper operations will be disabled.

Note: After the windshield wipers are switched on, if the shift lever is moved to the R position, the rear wiper will operate.

INSTRUMENTS AND CONTROLS

Steering System

Adjustment of Steering Column



DO NOT attempt to adjust the height or angle of the steering column while the car is in motion. This is extremely dangerous.

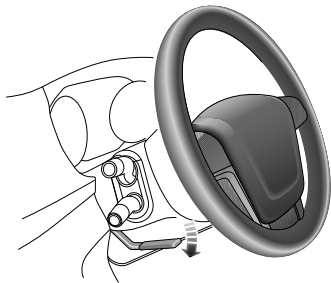

To adjust the angle or height of the steering column to suit your driving position:

- 1 Fully release the locking lever.
- 2 Hold the steering wheel in both hands and tilt the steering column up or down to move the wheel into the most comfortable position.
- 3 Push or pull the steering wheel towards or away from the body.
- 4 Once a comfortable driving position has been selected, pull the locking lever fully up to lock the steering column into its new position.

Electric Power Assisted Steering



If the electric power assisted steering fails or cannot operate the steering will appear very heavy, this will effect driving safety.

The electric power assisted steering system only works when the engine is running. The system operates via a motor with assistance levels automatically adjusted based on vehicle speed, steering wheel torque and steering wheel angle.

IMPORTANT

Holding the steering wheel on full lock for long periods will result in a reduction in power assistance causing a heavier feel to the steering for a small period of time.

Electric Power Assisted Steering (EPS)/Steering Angle Sensor (SAS) Warning Lamps

See "Warning Lamps and Indicator Lamps" under the "Instruments and Controls" section.

If the battery has been disconnected for any reason, upon reconnection the warning lamp will illuminate yellow. Movement of the steering wheel from lock to lock will initialise the system and the lamp will extinguish.

INSTRUMENTS AND CONTROLS

Horn



When the ignition switch is in position I or II, press the horn button area (indicated by arrow) on the steering wheel to operate the horn.

Note: *The vehicle horn press and the driver's airbag are located in close proximity on the steering wheel. The illustration shows the position of the horn,*

please ensure that you press in this area to avoid any potential conflict with the operation of the airbag.

IMPORTANT

To avoid possible SRS issues, please do not press with excessive force or hit the airbag cover when operating the horn.

Rearview Mirrors

Exterior Rearview Mirrors

Note: *Objects viewed in exterior rearview mirrors may appear further away than they actually are.*

Electric Adjustment of Exterior Rearview Mirror Glass

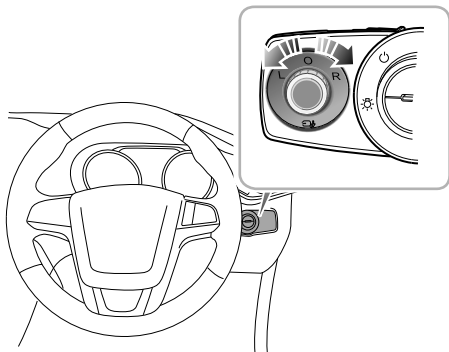

- When the ignition switch is in position I or II, rotate the knob to select left (L) or right (R) rearview mirror.
- Push the knob in the desired direction to adjust the angle of the exterior rearview mirror glass.
- Upon completion of the adjustment, rotate the knob back to the central position, this will ensure no accidental adjustment of the mirror.

Exterior Rearview Mirror Heating*



The rearview mirrors have integral heating elements which disperse ice or mist from the glass. The heating elements operate while the Heated Rear Window is switched on.

Note: *The heated rear window and mirror heating elements only work while the engine is running.*

Exterior Rearview Mirror Folding

The exterior mirrors can be folded so as to avoid collision or allow passage through a narrow passage.

INSTRUMENTS AND CONTROLS

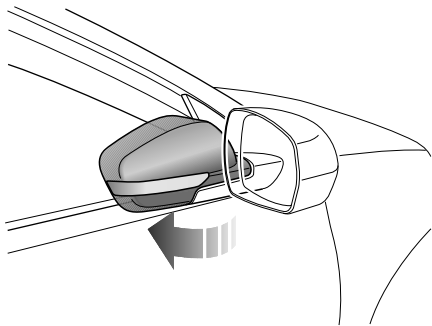

Manual Folding of Exterior Rearview Mirror *

For a vehicle equipped with exterior rearview mirror manual folding, the exterior rearview mirrors can only be folded backwards manually.

Electric Folding of Exterior Rearview Mirror *

For a vehicle equipped with exterior rearview mirror electric folding, when the ignition switch is in position I or II, rotate the knob to the middle position and push

the knob down. The exterior rearview mirrors will be folded automatically. Pushing the knob downwards again will return the mirrors to their original position.

Operating the key fob lock/unlock buttons will fold/unfold the door mirrors.

A folded door mirror will automatically unfold when the vehicle speed exceeds 10mph (15km/h) once per ignition cycle.

IMPORTANT

- Exterior rear view mirrors are operated by electrical motors. Operating them directly by hand may damage the internal components.
- Washing or flushing exterior rearview mirrors with high pressure water jets or car washes may result in electrical motor failure.
- Electrical folding rearview mirrors that have been moved from their positions by manual or accidental means must be reset manually before any electrical adjustments are made.

Interior Rearview Mirror

Before driving, adjust the body of the interior rearview mirror to achieve the best possible view. The anti-dazzle function of the interior rearview mirror helps to reduce glare from the headlamps of following vehicles at night.

Automatic Anti-dazzle Interior Rearview Mirror *

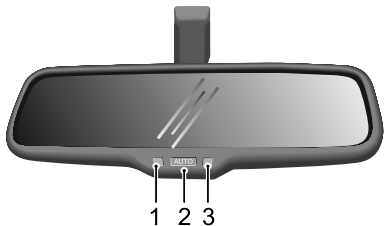

- 1 Operation Indicator
- 2 Automatic Anti-dazzle Function Switch
- 3 Light Sensor

After the car is started, the automatic anti-dazzle function is switched on automatically (operation indicator ON). When a following vehicle's headlights could dazzle the driver, the light sensor activates the anti-dazzle function. Press the automatic anti-dazzle function switch (operation indicator OFF) to switch off the automatic anti-dazzle function, and press it again to re-start this function.

The automatic anti-dazzle function can be inhibited if:

- The light from the vehicle behind is not seen by the light sensor.
- Darkening or tinting of the rear window effects the light entering the car from the vehicle behind.
- Reverse gear is selected.

INSTRUMENTS AND CONTROLS

Manual Anti-dazzle Interior Rearview Mirror *

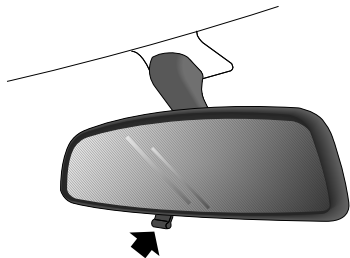

Move the lever at the base of the interior rearview mirror to change its angle, so as to achieve the anti-dazzle function. Normal visibility is restored by pulling the lever back again.

Note: In some circumstances, the view reflected in a 'dipped' manual mirror can confuse the driver as to the precise location of following vehicles. Remember to take additional care.

Sunvisor



The vanity mirror on the driver side should only be used when the car is stationary.

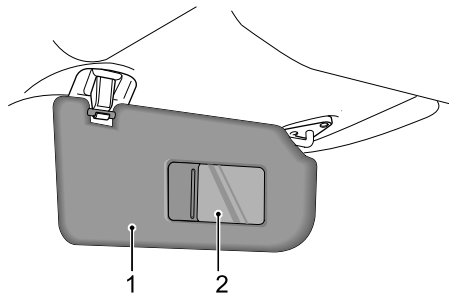

Sunvisors (1) are arranged on the roof ahead of both the driver and the front passenger. Some models have vanity mirror (2), depending on the vehicle configuration.

For the models which have vanity mirror. Pull the sunvisor downward to use the vanity mirror.

INSTRUMENTS AND CONTROLS

Windows

Power Operated Window Switch

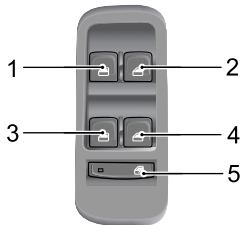

- 1 Front Left Window Switch
- 2 Front Right Window Switch
- 3 Rear Left Window Switch
- 4 Rear Right Window Switch
- 5 Rear Window Isolation Switch

Window Operation



Ensure children are kept clear when raising or lowering a window.



Improper use or activation of the electric windows or sunroof by children could cause serious harm or even death. It is the responsibility of the driver and adult passengers to ensure that when carrying children the necessary steps are taken to isolate the window and sunroof operation. This should include the removal of the ignition key when children are left alone in the vehicle.



Special care should be taken if operating any form of automatic global opening or closing function. It is essential to check that all items that will be operated are clear of obstruction. Failure to ensure this could result in serious injury.

Press the switch (1-4) to open the window, pull the switch to close the window, The window will stop moving as soon as the switch is released (unless the 'One-Touch' function is active).

Note: The front and rear passenger windows can also be operated by individual window switches, mounted on each door. The rear window switches will not function if the rear window isolation switch (5) on the driver door has been activated.

Note: When the ignition switch is in position I or II, the power window can be operated (For safety: doors should be closed).

Rear Window Isolation Switch

Press the switch (5) to isolate the rear window controls (an indicator lamp in the switch illuminates), and press again to restore control.

Note: It is recommended that you ISOLATE the rear window switches when carrying children.

One Touch Down *

Short press the window control switch (1 to 4) to the "2" position and release. The corresponding window automatically descends to fully open. Window movement can be stopped at desired position at any time by briefly pulling up the corresponding switch during descent.

One Touch Up with Anti - Trap

The front right window (2) has the "one-touch" up function, the operating manner of this function is the same with that of the "one-touch" down function. Window movement can be stopped at desired position at any time by briefly pressing the switch again.

The 'Anti-Trap' function is a safety feature which prevents the window from fully closing if an obstruction is sensed - if this happens the window will open slightly to allow the obstruction be removed.

Note: Do not operate the power window controls continuously for more than 20 seconds, otherwise the power window controls may be disabled to protect

INSTRUMENTS AND CONTROLS

the motor. If this occurs, please wait until the motor cools down.

Note: If the battery is disconnected, the 'One-Touch' and 'Anti-Trap' features will be lost, the message centre will display 'Please Initialise Driver Window'. To restore this feature, fully open and then fully close the window holding the switch for 5 seconds in the closed position.

Interior Light

Front Courtesy and Map Reading Lights

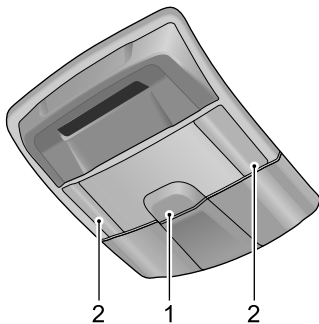

Manual Operation

Press the switch (1) to turn the courtesy light on, press again to turn off. Press one of the switches (2) to turn on a map reading light, press again to turn off.

Automatic Operation

Courtesy light illumination occurs automatically whenever the following occur.

- The car is unlocked.
- Any door or the tail gate is opened.
- The ignition is switched off, providing the sidelights have been illuminated during the previous 30 seconds.

Note: *If a door or the tailgate is left open for longer than 15 minutes, a 'time-out' function will extinguish the interior lights automatically to prevent the battery from discharging.*

If necessary, the automatic illumination features described above can be switched off, as follows:

When the ignition is in positions I or II, press and hold the courtesy light switch (1) for 5 seconds. The interior lights will flash and then extinguish. Automatic operation is suspended (manual operation is still available). To restore automatic operation, repeat the above process.

INSTRUMENTS AND CONTROLS

Rear Courtesy Light



Press the switch (arrowed) to illuminate the courtesy light, press again to switch off.

Power Socket

Front Console Power Socket



Please ensure the socket lid is inserted when the power socket is not in use. This will ensure no debris or foreign objects enter the socket preventing its use or cause short circuits.

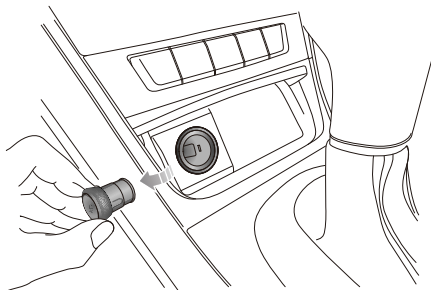

The front console power socket is located below the hazard warning lamp switch. When the ignition switch is in position I or II, raise the ashtray cover plate and extract the plug to use the socket.

Please fit the power socket plug after use.

Note: *The voltage of the front console power socket is 12 volt, and the power rating is 120 watt.*

Note: *Extended use of the accessory power socket when the engine is switched off will cause premature discharging of the vehicle battery.*

INSTRUMENTS AND CONTROLS

Rear Loadspace Power Socket *

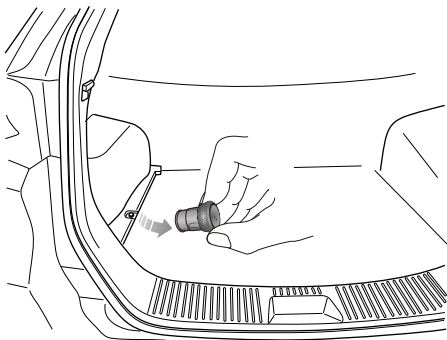

Note: *Extended use of the accessory power socket when the engine is switched off will cause premature discharging of the vehicle battery.*

The rear loadspace power socket is located at the left of the rear loadspace. When the ignition switch is in position I or II, extract the plug to use the socket.

Please fit the power socket plug after use.

Note: *The voltage of the rear loadspace power socket is 12 volt, and the power rating is 120 watt.*

Storage Devices

Instructions

- Please close all storage devices when the car in motion. Leaving these storage devices open may cause personal injuries in cases of a sudden start-off, emergency braking and a car accident.
- Do not place flammable materials such as liquid or lighters in any storage devices. The heat in hot conditions may ignite flammable materials and lead to a fire.

Glove Box

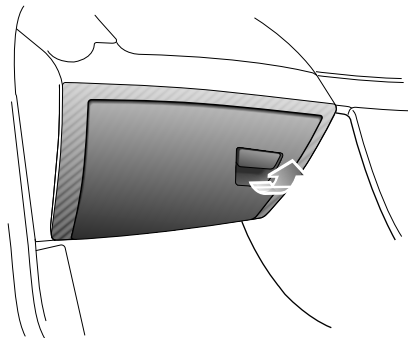

Pull the handle on the glove box cover to open the glove box, the glove box light * will automatically illuminate.

Some cars are equipped with glove box cold storage *. Set the air conditioning to cool and rotate the knob located at the top of the glove box interior to use this function.

INSTRUMENTS AND CONTROLS

Push the lid forward to close the glove box. Make sure the glove box is fully closed when the car is driving.

Storage Box – Centre

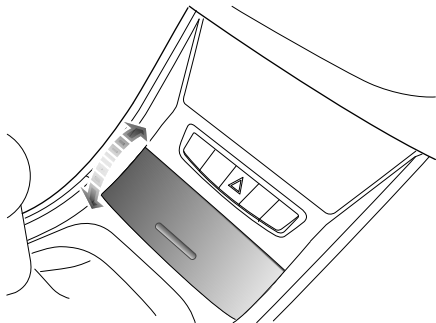

The storage box is situated at the front end of the centre console. The storage box cover * is model dependant.

If a cover is provided, gently press the front edge of the cover to open the storage box.

Storage Box – Driver Side

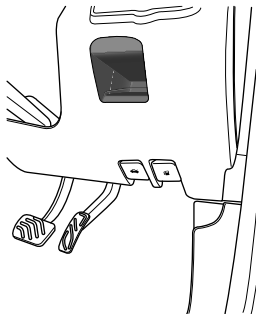

Located at the lower side of the instrument panel on the driver side.

Cubby Box

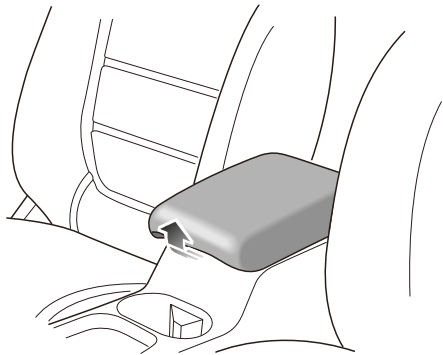

Lift the armrest (arrowed) to open the compartment cover.
Put the cover down to close it.

INSTRUMENTS AND CONTROLS

Cup Holder



Do not place hot drinks in the cup holder whilst driving. Spillage may result in personal injury or damage.

Centre Console Cup Holder

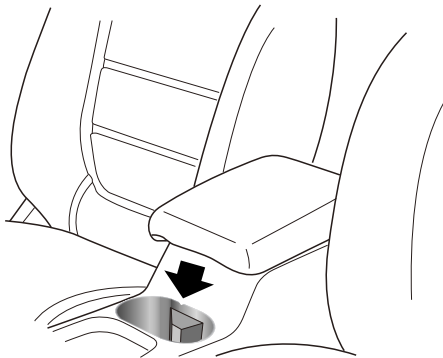

The centre console cup holder is situated at the front end of the centre console armrest assembly, and is used to hold a cup or beverage bottle.

Rear Armrest and Rear Cup Holder

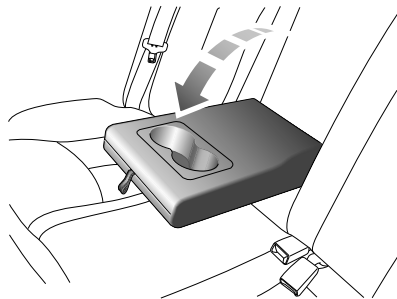

Fold forward to open the rear armrest. There are cup holders at the front end of the rear armrest to hold beverage cups etc.

Roof Luggage Rack *



Roof loads *MUST NOT* exceed the maximum authorised load. This may lead to injury or vehicle damage.



Loose or improperly fixed loads may fall from the roof luggage rack and lead to an accident or cause injury.



When heavy or large items are carried on the roof luggage rack it may lead to changes in steering, handling and braking characteristics. Please avoid sharp maneuvers, heavy braking and excessive acceleration.

Pay attention to the followings when using the roof luggage rack:

- Secure loads at the front of the roof as far as possible. distribute loads evenly.
- DO NOT use automatic car washes with loads on the roof luggage rack.

- The overall height of the car is different when loads are fitted to the roof luggage rack. Please ensure there is adequate clearance when entering tunnels and garages.
- Ensure the loads carried by the roof luggage rack do not impede operation of the sunroof, roof antenna of tailgate opening.
- When installing or removing a piece of loading equipment, follow the instructions provided by the manufacturer of the loading equipment.

Maximum Authorised Load for the Roof

The maximum authorised load for the roof is 50 kg, this includes the weight of the roof loads and that of the loading equipment installed.

Ensure you are aware of the weight of loads, and weigh them when necessary. Never exceed the maximum authorised load for the roof.

Periodical Check

Always check the condition of bolt connectors and fasteners before using the rack luggage rack. Periodically check the condition of bolt connectors and fasteners.

Air Conditioning and Audio Systems

64 Ventilation

67 Manual Temperature Control *

70 Automatic Temperature Control *

76 Radio

85 Entertainment System *

AIR CONDITIONING AND AUDIO SYSTEMS

Ventilation

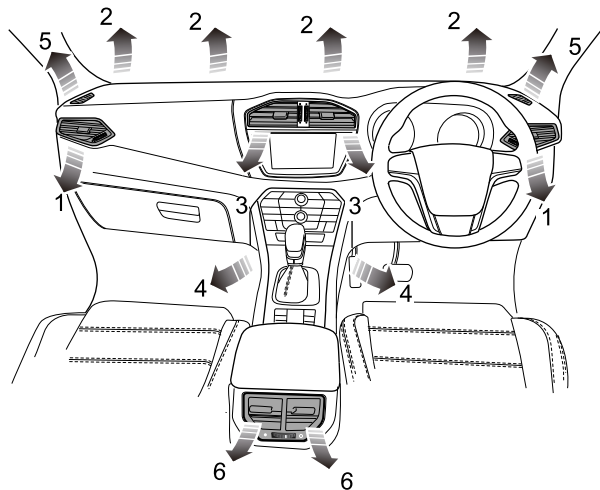

- 1 Side Vents
- 2 Windscreen Vents
- 3 Centre Vent
- 4 Front Seat Feet Vents
- 5 Front Side Window Vents
- 6 Centre Console Vents *

There are also 2 rear seat feet vents, respectively on the floor under the front seats (not shown in the figure).

AIR CONDITIONING AND AUDIO SYSTEMS

The heating, ventilation and air conditioning system provides fresh, cooling or heated air to the interior of the car from the air intake grille in front of the windscreen.

Always keep the air intake grille clear of obstructions such as leaves, snow or ice.

Particle/Pollen Filter

The particle/pollen filter helps to keep the car interior free from pollen and dust. To remain fully effective, the filter should be replaced at the recommended service interval.

Vents

Centre Vents

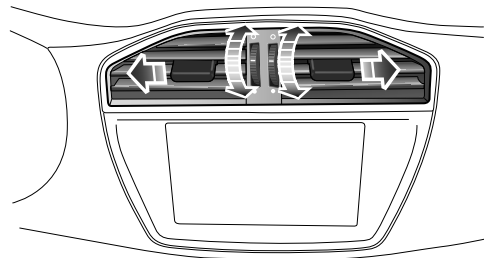

Rotate the thumb-wheel towards ● to close the centre vents, while rotate the thumb-wheel towards ○ to open the centre vents. Direct the air flow by moving the control in the centre of the louvres up or down, or from side to side.

AIR CONDITIONING AND AUDIO SYSTEMS

Side Vents

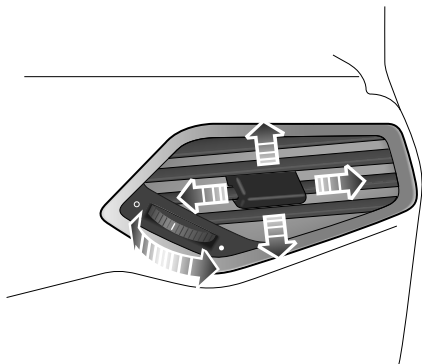

Rotate the thumb-wheel towards ● to close the side vents, while rotate the thumb-wheel towards ○ to open the side vents. Direct the air flow by moving the control in the centre of the louvres up or down, or from side to side.

Centre Console Vents *

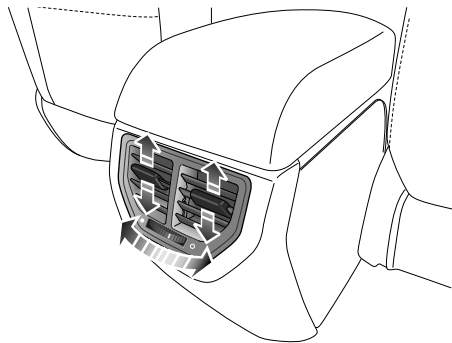

Rotate the thumb-wheel towards ● to close the centre console vents, while rotate the thumb-wheel towards ○ to open the centre console vents. Direct the air flow by moving the control in the centre of the louvres up or down, or from side to side.

AIR CONDITIONING AND AUDIO SYSTEMS

Manual Temperature Control *

Control Panel

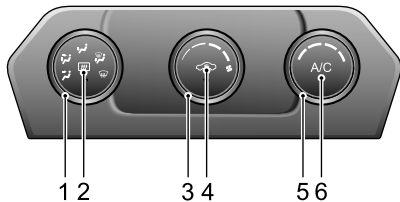

1 Air Distribution Mode

2 Heated Rear Screen

3 Blower Speed Control

4 Air Circulation Mode

5 Temperature Control

6 A/C On/Off

Blower Speed Control

Rotate the blower control clockwise to increase the blower speed or rotate anti-clockwise to reduce the blower speed. The blower is switched off when the blower speed is 0, and the blower speed increases gradually from 1 to 4.

Note: Select blower speed to 0 to turn off the air conditioning system; select blower speed 1-4 to turn on the air conditioning system.

Temperature Control

Rotate the temperature control knob clockwise to increase the temperature or rotate anti-clockwise to reduce.

A/C On/Off



Press the A/C Button to switch on the air cooling function of the air conditioning system. The A/C button indicator illuminates. Press again to switch off.

AIR CONDITIONING AND AUDIO SYSTEMS

Note:

- 1 *A/C will only operate when the engine is running.*
- 2 *The heating function is still available, when the air cooling is switched off.*
- 3 *A small amount of water may remain in the air conditioner after usage, this may produce a peculiar smell. if this is a particular issue, it is recommended to switch of the cooling function and run the blower for 5 seconds with the engine running prior to switching off.*

Air Distribution Mode

Rotate the air distribution mode knob, select the air distribution mode as required.



For 'face'. Directs air to the side, centre and centre console vents.



For 'feet' and 'face'. Directs air to the side, centre, centre console and feet vents.



For 'feet'. Directs air to the feet vents.

Note: *In this mode, a small amount of airflow will be directed to the side vents and window vents.*



For 'windscreen' and 'feet'. Directs air to the windscreen and feet vents.

Note: *In this mode, a small amount of air will be directed to the side vents.*



For 'windscreen/demist/defrost'. Directs air to the windscreen vents.

Note: *In this mode, a small amount of air will be directed to the side vents.*

Note: *Selecting windscreen/demist/defrost will automatically activate the air cooling function and engage the A/C compressor. This reduces the time taken to demist the windscreen.*

Heated Rear Window



The heating elements on the inside of the rear screen are easily damaged. DO NOT scrape or scratch the inside of the glass. DO NOT stick labels over the heating elements.



Press to operate; the indicator in the switch will illuminate . The heated rear window will switch off automatically after 12 minutes. When the heated rear window is working, press the button to switch off the function .

Note: *The heated rear window function will only function when the engine is running.*

Air Circulation Mode



Press the Air Circulation Mode button to operate, the lamp in the switch illuminates, the air intake is closed and the air inside the car is recirculated, preventing the entry of traffic fumes.

When the engine is off, the air recirculation control flap stays in current position.

Note: *Leaving the system in recirculation mode can cause the windscreen to mist. If this happens, switch off recirculation and turn the controls to maximum demisting.*

AIR CONDITIONING AND AUDIO SYSTEMS

Automatic Temperature Control *

Control Panel

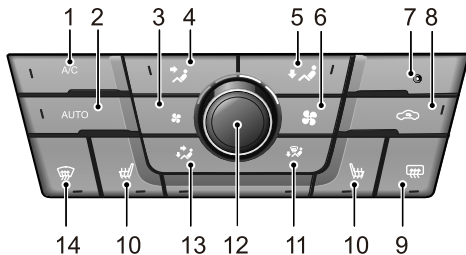

- 1 A/C On/Off
- 2 AUTO Button
- 3 Blower Speed Down Button
- 4 Face Mode Button
- 5 Feet Mode Button
- 6 Blower Speed Up Button
- 7 Sensor (Not Button)
- 8 Air Circulation Mode Button
- 9 Heated Rear Window Button
- 10 Front Seat Heating Button *
- 11 Windscreen and Feet Mode Button
- 12 Temperature Control Knob/System On/Off
- 13 Face and Feet Mode Button
- 14 Defrost/Demist Button

AIR CONDITIONING AND AUDIO SYSTEMS

Air Conditioning System Display

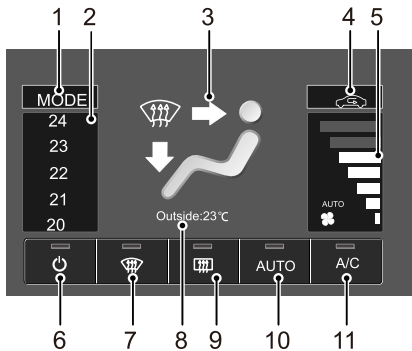

- 1 Air Distribution Mode Touch Button
- 2 Temperature Control Touch Swipe Control
- 3 Air Distribution Mode Display
- 4 Air Circulation Mode Touch Button
- 5 Blower Speed Control Touch Button
- 6 System On/Off Touch Button
- 7 Defrost/Demist Touch Button
- 8 Outside Ambient Temperature Display
- 9 Heated Rear window Touch Button
- 10 AUTO Touch Button
- 11 A/C On/Off Touch Button

AIR CONDITIONING AND AUDIO SYSTEMS

Air Distribution Mode

Press the corresponding distribution mode button or touch button to select air distribution mode. The corresponding button indicator on control panel illuminates, and the air conditioning system display shows the corresponding icon.



For 'face'. Directs air to the side, centre and centre console vents.



For 'feet' and 'face'. Directs air to the side, centre, centre console and feet vents.



For 'feet'. Directs air to the feet vents.

Note: *In this mode, a small amount of airflow will be directed to the side vents and window vents.*



For 'windscreen' and 'feet'. Directs air to the windscreen and feet vents.

Note: *In this mode, a small amount of air will be directed to the side vents.*

Temperature Control

Rotate the temperature control knob or press the touch button on the display to select the air temperature. The range of the set temperature is 18°C ~ 26°C.

When the requested temperature is lower than 18°C, the system enters into the maximum cooling status, while the set temperature column on the air conditioning system display shows "Lo".

When the requested temperature is higher than 26°C, the system enters into the maximum heating status, while the set temperature column on the air conditioning system display shows "Hi".

Automatic Temperature Control Mode

Rotate the temperature selected knob or press the touch button on the display, after setting the required target temperature, press the AUTO button to enter into the automatic temperature control mode.

AIR CONDITIONING AND AUDIO SYSTEMS

2

In the "AUTO" mode, the system adjusts the air distribution mode, the blower speed as well as the internal/external circulation state automatically, to achieve and maintain the required target temperature. At this time, the "AUTO" icon will be shown on the display.

Note: *In AUTO mode, if external temperature is low, the blower speed will increase after the engine temperature has risen.*

Note: *To ensure the AUTO control operates efficiently, all windows and the sunroof must be closed and the inlet vents must be clear of obstruction. Do not shield the solar sensor (on top of the dashboard) and interior temperature sensor (on the control panel).*

A/C On/Off

A black square icon with the white text "A/C" inside.

Press the A/C Button or the touch button to switch on the display on the air cooling function of the air conditioning system. The A/C button indicator illuminates. Press again to switch off.

Note:

- 1 A/C will only operate when the engine is running.*
- 2 The heating function is still available, when the air cooling is switched off.*
- 3 A small amount of water may remain in the air conditioner after usage, this may produce a peculiar smell. If this is a particular issue, it is recommended to switch off the cooling function and run the blower for 5 seconds with the engine running prior to switching off.*

Blower Speed

Press the Blower Speed Up Button or select the larger blower speed segments on the display to increase blower speed; press the Blower Speed Down Button or select the smaller the blower speed segments on the display to decrease blower speed. The air conditioning system display will show the corresponding blower speed with the quantity of segments.

Press the Blower Speed Button in the AUTO state, the AUTO icon will disappear, the blower speed enters into

AIR CONDITIONING AND AUDIO SYSTEMS

the manual control, other functions will maintain the state in which they were in.

When the air conditioning system is turned off, press the blower speed up button, all functions will resume to the state in which they were in before the system is switched off.

Defrost/Demist



Press Defrost/Demist Button on the control panel or the touch button on the display, the indicators on the button and display illuminate, the A/C and external circulation functions are switched on, and the system enters the most effective warm or cold air setting to clear the windshield and side window .

Pressing the Defrost/Demist Button or the touch button on the display again will exit the defrost/demist state, the indicator goes out, and the system will return to the previous state.

In the defrost/demist mode, operation of the A/C on/off button will switch the compressor on or off;

operation of the air circulation mode button will switch between internal circulation and external circulation, without affecting the defrost/demist mode in either case; operation of other air distribution modes will switch to a corresponding air distribution mode and quit the defrost/demist mode.

Heated Rear Window



The heating elements on the inside of the rear screen are easily damaged. DO NOT scrape or scratch the inside of the glass. DO NOT stick labels over the heating elements.



Press the Heated Rear Window Button on the control panel or the touch button on the display, the indicators on the button and display illuminate, and the heated rear window function starts to operate, and will stop automatically after 15 minutes; during this period, the user may press the button again to disable this function. The indicators on the button and display extinguish when the heated rear window is turned off.

Note: *The heated rear window function will only function when the engine is running.*

Air Circulation Mode



Press the Air Circulation Mode Button on the control panel or the touch button on the display, switch the circulation damper to internal circulation, the indicator on the key illuminates, and an internal circulation icon is displayed on the A/C display.

When the vehicle receives a reverse gear or windshield washing signal, external circulation will automatically switch to internal recirculation, this automatic switching function is prohibited in the defrost/demist mode.

Note: *Leaving the system in recirculation mode can cause the windscreen to mist. If this happens, switch off recirculation and turn the controls to maximum demisting.*

System On/Off



Press the System On/Off button on the control panel or the System On/Off touch button on the display. This will switch the system on or off. When switching on, the lamp and icon will extinguish and the system will revert to the settings prior to switching off. When switching off, the lamp and icon will illuminate.

Note: *When the air conditioning is switched off, the exterior ambient temperature and recirculation state will be displayed. The state of the recirculation system can be changed using the button.*

Note: *Turning off the entertainment system will only turn off the air conditioning system display, not the air conditioning system.*

AIR CONDITIONING AND AUDIO SYSTEMS

Radio

Instructions

- 1 When cleaning the vehicle, ensure that water does not contact the radio.
- 2 Use a soft cloth to clean the display. Use alcohol to remove stubborn dirt. Do not use water, solvent or abrasive cleaner, these substances will damage the display.
- 3 The radio is designed to operate between temperatures of $-20^{\circ}\text{C} \sim 70^{\circ}\text{C}$. When the temperature is very low in the vehicle, do not use this device immediately after switching on the heater.
- 4 The radio has precise mechanical parts. Do not open the housing, dismantle the mechanism or lubricate the rotating parts.
- 5 The USB port of the unit does not support portable hard disks.
- 6 The USB port of the unit may be used in conjunction with certain card reader models, support of all types of card readers cannot be guaranteed.
- 7 The USB port of the unit does not support connection with USB hub.
- 8 The USB port of the unit may not be able to identify some USB brands and models, some files may not be recognised and therefore not played correctly. Seek your MG Authorised Repairer.

IMPORTANT
Only use the radio controls when road conditions permit.

AIR CONDITIONING AND AUDIO SYSTEMS

Radio Control Panel

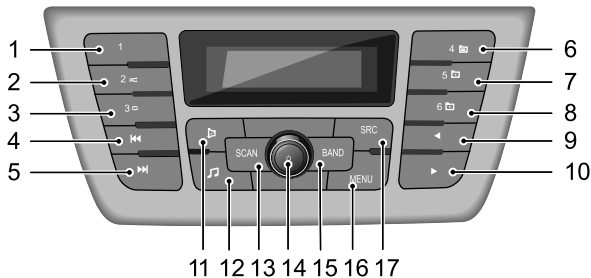

- 1 Preset Button [1]
- 2 Preset Button/Random Button [2↻]
- 3 Preset Button/Cycle Button [3↻]
- 4 [⏮] Button
- 5 [⏭] Button
- 6 Preset Button/Information Button [4📄]
- 7 Preset Button/Previous Folder [5📄]
- 8 Preset Button/Next Folder [6📄]
- 9 [◀] Button
- 10 [▶] Button
- 11 [🔇] Mute Button
- 12 [🎵] EQ Button
- 13 [SCAN] Button
- 14 [Off/On] Button / [Volume] Knob
- 15 [BAND] Button
- 16 [MENU] Button
- 17 [SRC] Button

AIR CONDITIONING AND AUDIO SYSTEMS

Basic Operation

Power On/Off

Press [Off/On] button to start the system, and press it again to turn off the system.

30 Minutes Play Function

When the ignition is switched off, press the On/Off button to operate the audio unit for up to 30 minutes. After 30 minutes the unit will switch off. To switch on again, press the On/Off button.

Note: To avoid excessive battery power drain please use in moderation.

Mute/Pause

In the RADIO/AUX mode, press [] button to mute the sound. Press it again to resume audio sound.

If in USB play, press [] button to pause USB play. Press it again to resume play.

Select Mode

Repeatedly press [SRC] button, the system will cycle between RADIO and USB (if any USB is connected)/AUX.

Press [BAND] button, the system will cycle between [FM1]/[FM2] and [FMA]/[AM].

Note: USB can only be selected when a USB source is connected.

Volume Adjustment

Turn the [Volume] knob counterclockwise, the volume will decrease in increments of 1, the minimum volume is 0. Turn the [Volume] knob clockwise, the volume will increase in increments of 1, the maximum volume is 32.

EQ Setting

Sound Effect Setting

For each press of [🎵] button, the system will cycle between BASS/TREBLE/BALANCE/EQ PRESET/LOUDNESS.

BASS

In [BASS] mode, press [◀]/[▶] button or turn [VOLUME] knob to adjust the BASS effect (adjustment range: -7 ~ +7).

TREBLE

In [TREBLE] mode, press [◀]/[▶] button or turn the [VOLUME] knob to adjust the TREBLE effect (adjustment range: -7 ~ +7).

BALANCE

In [BALANCE] mode, press [◀]/[▶] button or turn [VOLUME] knob to adjust the BALANCE effect (adjustment range: L7 ~ R7), "0" represents balance.

EQ PRESET

In [EQ PRESET] mode, press [◀]/[▶] button or turn [VOLUME] knob to adjust the EQ to JAZZ/POP/CLASSIC/VOCAL/ROCK/OFF.

LOUDNESS

In [LOUDNESS] mode, press [◀]/[▶] button or turn [VOLUME] knob to turn on/off the loudness control.

AIR CONDITIONING AND AUDIO SYSTEMS

Radio Function

Mode Selection

Press [SRC] button to select radio as the source.

Press [BAND] button to select the band.

Band Selection

Press [BAND] button again to select FM1, FM2, FMA or AM.

Note: If the radio is in stereo, the top of the screen will display 'ST'.

Tuning

There are 3 tuning modes: search tuning, manual tuning and preset tuning.

Search Tuning

Press [◀▶]/[▶▶] button, the radio automatically searches the frequency range, looking for a radio station of acceptable strength. Once a station is found, that station will be played.

Note: If no station is found within the selected waveband, the radio will stop searching after a cycle, and the screen will display "NO STATION".

Manual Tuning

Press the [◀]/[▶] button to adjust the tuning manually.

Preset Tuning

The memory has 24 preset positions (FM1, FM2, FMA, AM) for storing stations. Press numbers 1 ~ 6 to select a stored frequency.

Storing a Station

There are manual and auto store modes.

Manual Store

- Press [BAND] button to select the desired waveband.
- Use search, manual or preset tuning to tune to the desired station.
- Press (more than 2 s) any preset button to store current station frequency into the preset memory (the screen displays the station waveband and frequency stored).

Note: *Manual store overwrites any stations which already stored in the memory.*

Auto Store

- Press [BAND] button to select FM1, FM2 or FMA.
- In FM1, FM2 or FMA mode, with a long press on [BAND] button, the screen will show "AUTO STORING". The 6 strongest frequencies will be stored in FMA according to signal strength. When the screen disappears, the storage is finished.

Note: *AM mode has no auto storage function.*

Note: *Auto storage of FMA overwrites any stations already stored by the number buttons.*

View Station

In RADIO mode, short press [SCAN] button to automatically search the radio stations upwards through the frequency. When a station is found, the system will automatically stop searching. During searching, the system stops in each station for 5 s. Press [SCAN] button to play the station.

View Preset Station

In RADIO mode, long press [SCAN] button to scan through the preset stations, the system stops in each preset station for 5 s. Press [SCAN] button to play the station.

AIR CONDITIONING AND AUDIO SYSTEMS

USB/AUX

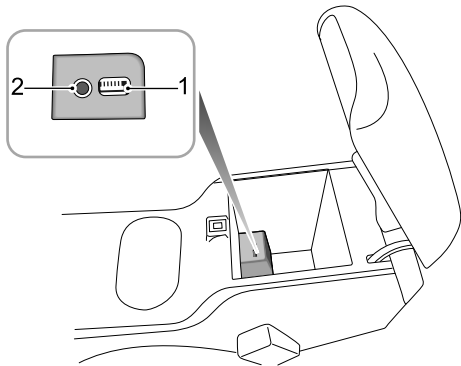

- 1 USB Port
- 2 AUX Port

USB Playing

- In RADIO or AUX mode, press [SRC] button to select USB mode.

- When inserting a USB into the USB port, the player will automatically shift to USB mode and play from the first song.

Track Search

Press [▶▶] button to play the next song.

If the track elapsed time is more than 3 s, press the [◀◀] button once to return to the start of the current track and press again to start the previous track.

If the elapsed time is less than 3 s, press the [◀◀] button to play the previous track.

Note: The system can play .mp3 and .wma files only.

Folder Mode

When the USB is playing, press [5◀] / [6▶] to select the previous or next folder.

Repeat Play

When the USB is playing, short press [3◀] button to replay the current track, press the button again to play the current

folder in cycle mode, give the button another press to cancel the cycle mode.

Random Play

When playing the USB, short press [2>≡] button to play the current folder in random mode, press it again to play the USB randomly and give it another press to cancel the random mode.

View Play Mode

When playing the USB, short press [SCAN] button to scan the current folder, press it again to scan the USB and give it another press to cancel the view play mode.

In VIEW mode, each track will be played for 10 s before playing the next track, after all tracks are played in cycle mode, this function will be cancelled automatically. When a desired track occurs, press the [SCAN] button to stop the View mode and return to the normal state to enjoy the track.

Track Information Display

When playing the USB, the radio will display the name of the track file. When the screen cannot display the full name of the file, the radio will display it on the next page automatically. A long press on [4≡] button, will display the file name by scrolling the screen.

When playing the USB, a short press on [4≡] button, will display: title - play time - album - folder name - file name-title.

Note: *When the full name of the folder can be displayed, the system will not scroll the screen and turn to the next page.*

Removing USB

Do not remove USB directly when it is playing, it will damage the USB files.

AUX Input Playing

After connecting the external audio device to the AUX socket, the system will enter the AUX mode automatically and the music in the external audio source is played by the system.

AIR CONDITIONING AND AUDIO SYSTEMS

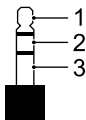

- 1 Left channel
- 2 Right channel
- 3 GND

Note: Please use 3.5 mm TRS plugs to connect the AUX audio.

Note: Ensure the external audio source is in switched ON.

MENU Setting

Speed Dependant Volume (Speed Vol)

When the SPEED VOL function is activated, the volume of the player will vary with the vehicle speed automatically. Set the [SPEED VOL] by the following ways:

- 1 Short press [MENU] button to go to the "SPEED VOL" setting interface.
- 2 Press the [▶]/[◀] button or turn [VOLUME] knob to select the level of the SPEED VOL (LEVEL 0 ~ LEVEL 5).

Entertainment System *

Important Safety Information

- Do not attempt to fit, repair or modify the entertainment system by yourself, because there are high-voltage components in the device, which may cause electric shock. For internal inspection, adjustment or repair, please consult a local Authorised Repairer.
 - Do not allow this entertainment and navigation system to come into contact with liquids. If liquids or foreign objects enter into this entertainment and navigation system, please park your vehicle at a safe place, immediately switch off the ignition and contact a local MG Authorised Repairer. Do not use the entertainment and navigation system in this condition because doing so may result in a fire, electric shock, or other failure.
 - If you notice smoke, abnormal noises or odours from the entertainment system, or any other abnormal signs on the screen, switch the ignition off immediately and contact a local MG Authorised Repairer for service.
- Using this entertainment system under this condition may result in permanent damage to the system.
- Operation of the navigation or video functions of the system is prohibited whilst the vehicle is in motion. MG Motor UK accepts no responsibility for any consequences caused by this operation. Please park your vehicle in a safe location and apply the parking brake before making the necessary adjustments or watching "Video".
 - Particularly high or particularly low temperatures will interfere with normal operation. If the vehicle engine is not running, and parked in direct sun or in a cold location for a long time, the car may become particularly hot or cold, in this environment the system may not work properly. Once the temperature inside the car is back to normal, the system will resume normal function. If it does not resume, please contact an MG Authorised Repairer for assistance.
 - Switch off entertainment and navigation system during refuelling.
 - Be sure to run the vehicle engine while using this entertainment and navigation system. Using this

AIR CONDITIONING AND AUDIO SYSTEMS

entertainment and navigation system without running the engine can drain the battery.

- If the battery is disconnected or discharged, the data stored in the memory of this entertainment and navigation system will be erased.
- When using a mobile phone, keep the antenna of the mobile phone away from the screen to prevent the disruption of video signal in the form of spots, colored stripes, etc. on the screen.
- To protect the screen against damage, be sure to touch the panel buttons with your finger (a touch pen can be used for special calibration).
- The navigation system is designed only as a guide and does not relieve the driver of the responsibility for driving in accordance with traffic regulations.

Cautions for Using Screen



To protect the screen against damage, always touch the panel buttons with your finger. A touch pen may be used for special calibration. The touch pen should not be used for normal operation. The screen will not display the boot screen at power on in suspend mode.

- Please take care to protect the screen against direct sunlight. Extended exposure to direct sunlight will result in screen malfunction due to high temperature.
- When the temperature is beyond the operating temperature range (-20°C to $+65^{\circ}\text{C}$), please do not use the screen, because the screen may not operate normally and could be damaged.
- Make sure that the warm or cool air flow from the air conditioner is not distributed on the screen directly, damage to the entertainment device may occur due to heat or moisture.
- Do not use excessive force to drag and drop or press the screen, damage or scratching may occur.

- To remove dust from the screen or clean the screen, please turn the system off first, then wipe with a dry soft cloth. When wiping the screen, take care not to scratch the surface. Do not use irritative or abrasive chemical cleaners.
- When the backlight reaches the end of its service life, the screen will become dimmer and the image will no longer be visible, please contact a local MG Authorised Repairer.

Note: *The images in this manual are illustrations only for your reference.*

Note: *Along with the product improvement, specifications and designs are subject to change without any prior notice.*

Note: *All rights related to this document are reserved.*

Note: *Without the permission of the copyright owner, reproduction and usage of this document in any form, either in whole or in part, is strictly prohibited.*

Playable File Format for Entertainment System

Precautions

- Some types of external storage devices may not be recognised. This may result in the files not being played or displayed correctly.
- Because of file characteristics, file format, recorded application, playback environment, storage conditions and other factors, it may not be possible to play the files normally.

Audio Support

The entertainment system supports the following audio formats, other formats may not work normally.

MP3, WMA, AAC, OGG, ID3 Tag info, WAV, APE andFLAC.

Video Support

The entertainment system supports the following video formats, other formats may not work normally.

WMV, ASF, H264, MPEG2, MPEG4 andHD Video Playback.

AIR CONDITIONING AND AUDIO SYSTEMS

Supported Texts/Images

The entertainment system supports the following text/image formats, other formats may not work normally.

JPEG, GIF, BMP, PNG.

iPod/iPhone Compatibility

The entertainment system supports IOS 6.0 or higher version, other models or versions may not work correctly.

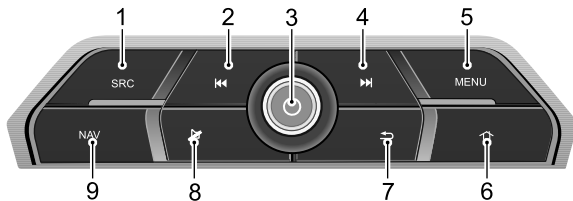

Basic Operations

Entertainment Player Control Panel



- 1 SRC: Switch to next available multimedia function.
- 2 **⏮** When playing audio/video, short press to switch to previous music/video, and long press to fast forward. When playing the radio, short press to switch to previous station; long press to search and play the previous station; long press continuously, the system will search through a cycle, then stop at the current station and continue to play it.
- 3 Power Button/Volume Knob: short press to shift between working state and suspend state. Long press for 10 seconds to restart the system. Rotate to adjust the system volume.
- 4 **⏭** When playing an audio/video, short press to switch to next music/video, and long press to fast forward. When playing the radio, short press to switch to next station; long press to search and play the next station; long press continuously, the system will search through a cycle, then stop at the current station and continue to play it.
- 5 MENU : short press to turn on/off the menu bar.

AIR CONDITIONING AND AUDIO SYSTEMS

- 6  short press to display the home page. Long press to turn off the screen backlight, the system operates normally, and the backlight will be turned on in case of any operation.
- 7 : Short press this button to return to previous level till the main interface; long press to return to the main interface directly.
- 8 : Mute/Cancel Mute
- 9 NAV (only for high-line) : short press to enter the navigation map screen.

Main System Interface

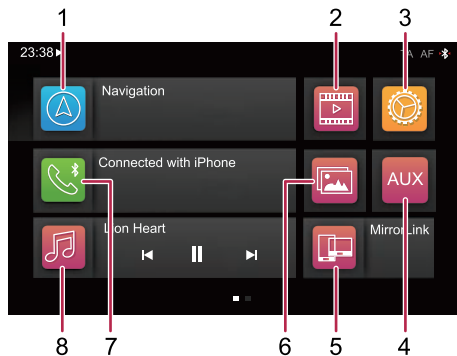

- 1 Navigation (only for high-line)
Touch to enter the Navigation interface.
- 2 Video
Touch to enter the Video interface.
- 3 Setting

AIR CONDITIONING AND AUDIO SYSTEMS

Touch to enter the Setting interface.

4 AUX

Touch to enter the AUX interface.

5 MirrorLink

Touch to enter the MirrorLink interface.

6 Picture

Touch to enter the Picture interface.

7 Phone

Touch to enter the Phone interface.

8 Radio/Music

Touch to enter the Radio/Music Playback interface.

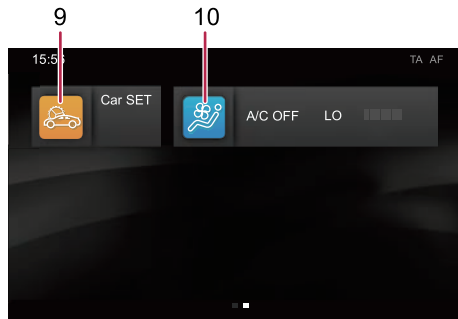

9 Vehicle Setting

Touch to enter the Vehicle Setting interface.

10 A/C

Touch to enter the A/C interface.

AIR CONDITIONING AND AUDIO SYSTEMS

Movement of Each Widget

Each widget can be repositioned to suit your personal requirements.

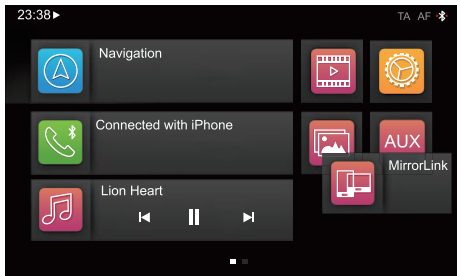

Press and hold the widget to be moved, then drag it to the desired position, other widgets will be automatically rearranged.

Power On/Off

Power On

If the vehicle power is turned off with the system in playback mode last time, the system will be automatically powered on when the vehicle power is turned on again.

If the vehicle power is turned off with the system in the Off state last time, short press the Power button on the system control panel to power-on the system after the vehicle power is turned on again.

With the system ON, long press the Power button on the system control panel for a period greater than 10 seconds, and the system will be automatically restarted.

Power Off

Turn off the vehicle power, and the system is automatically powered off.

Standby Mode

Short press the Power button to allow the entertainment system enter the standby mode, the operation of the system will be suspended.

There are two types of standby mode, which can be set in [Display] in [Settings].

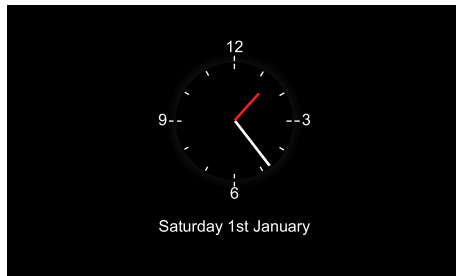

In the standby mode, all sounds will be muted, and the panel buttons can not be used for other operations. To cancel the standby mode, press the Power button again.

The standby mode can also be canceled by the following operations:

- The system automatically skips to the reverse screen during parking.
- Turn off the vehicle power, and the system is directly powered off.

AIR CONDITIONING AND AUDIO SYSTEMS

Steering Wheel Control Button *

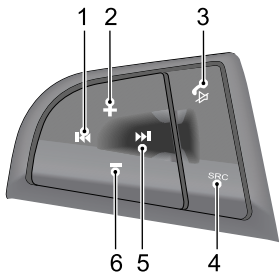

1 ◀◀ Button

When playing audio/video, short press to switch to previous track/video, and long press to fast rewind. While playing the radio, short press to switch to previous station; long press to search and play previous station; long press consistently, the radio will search one complete cycle and continue to play the current station.

2 Volume Up Button

3 🔇 Button

Short press to mute the system if not in calling/talking state. Short press to hang up if in calling/talking state; short press to answer and long press to refuse if in incoming call state.

4 SRC Button

Switch to next available media audio.

5 ▶▶ Button

When playing audio/video, short press to switch to next track/video, and long press to fast forward. While playing the radio, short press to switch to next station; long press to search and play next station; long press consistently, the radio will search one complete cycle and continue to play the current station.

6 Volume Down Button

AIR CONDITIONING AND AUDIO SYSTEMS

AV Connection



The storage box should be kept clean to avoid jack and port blocking, which may result in device failure.

Location

The AUX port and USB port are located in the storage box under the central armrest.

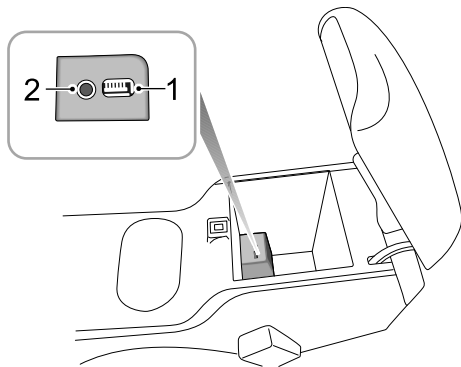

1 USB Port

Connect to a USB storage device using this port. The iPod connecting wire can also be connected.

2 AUX Port

Connect to an external audio/video device using a suitable connecting cable via this port.

AIR CONDITIONING AND AUDIO SYSTEMS

AUX Port

After connecting the external audio/video connecting wire to AUX port, the system will automatically read the files from external audio or video source. At this time, the sound from external audio or video source can be played via interior speakers.

Note: *Only use a suitable approved AUX cable, using any other cables may result in poor audio/video quality.*

Reverse Mode Audio Strategy

The reverse mode has a default volume setting of 10 (set value).

If the current volume is greater than the set value, after entering the reverse mode, the system will automatically decrease the current volume to the set value. After the system exits the reverse mode, the system volume will automatically resume the volume before the reverse mode.

If the current volume is less than the set value, the volume will not change after the system enters the reverse mode.

Note: *This function only applies to media-type audios.*

Volume Adjustment

- You can adjust the volume of different audio functions via the volume knob and steering wheel buttons. During the volume adjustment, the system may automatically pop up a volume indication window, this will display the current volume setting, and change in accordance with control request. When the volume operation is stopped for 3 seconds or other operations (e.g., pressing the panel button, touching the screen) are performed, the volume indication window automatically disappears.
- The system prompt volume can be adjusted through [Setting] in the main interface. Refer to "Setting" in this chapter for details.

Note: *The volume adjustment knob and steering wheel buttons can only adjust the volume in media and communication functions.*

Note: *The playback volume of Bluetooth audios, iPod audios and videos as well as AUX audios and videos can be adjusted through the devices themselves and this entertainment player.*

Connecting/Disconnecting a USB Storage Device

Inserting a USB Storage Device

The USB port is located in the storage box under the central armrest, insert a USB device into the USB port for connection.

Removing the USB Storage Device

Check and confirm that there is no data being accessed, then pull out the USB storage device.

Note: *Some USB storage devices may be unidentifiable.*

Note: *The entertainment device may not achieve optimum performance when some USB storage devices are used.*

Note: *Connection via a USB hub is not allowed.*

AIR CONDITIONING AND AUDIO SYSTEMS

Connecting/Disconnecting an iPod



To prevent data loss and damage to the storage device, while data is being transferred, never remove it from this entertainment system.

Connecting an iPod/iPhone

iPod/iPhone can be connected to the entertainment system by using iPod/iPhone USB connecting wire (sold separately).

Disconnecting an iPod/iPhone

Check and confirm that there is no data is being accessed, pull out the iPod/iPhone USB connecting wire.

Note: *Connection via a USB hub is not allowed.*

Note: *If data loss or damage occurs to the storage device for any reason, data will generally never be recovered. For damages, costs or expenses due to data loss or damage, MG Motor assumes no responsibility.*

Bluetooth Phone

Instructions

- Connection to all mobile phones featuring Bluetooth wireless technology is not guaranteed.
- The mobile phone that you use must be compatible with the entertainment system so that all functions of Bluetooth phone of the system can function correctly.
- When using Bluetooth wireless technology, this entertainment system may not be able to operate all functions on the mobile phone.
- When transmitting voice and data via Bluetooth technology, the straight-line distance between this entertainment system and the mobile phone should not exceed 10 metres. However, the actual transmission distance may be shorter than the estimated distance, depending on the usage environment.
- If Private mode is selected on the mobile phone, hands-free call function may be disabled.
- When the entertainment system is turned off, the Bluetooth connection will also be disconnected.

AIR CONDITIONING AND AUDIO SYSTEMS

- After the system restarts, the system will automatically attempt to reconnect previously-connected mobile phone. If the connection is terminated for some reasons, the system will automatically reconnect the specific mobile phone (except when the connection is terminated due to mobile phone operation).
- Due to Bluetooth wireless connection interruption or error occurring in the process of transmission in some extreme conditions, the entertainment system may not be able to be paired and connected with a mobile phone. At this time, it is recommended to clear the paired devices in the mobile phone and the device list on the entertainment system, and perform pairing again.

Bluetooth Pairing and Connection

Bluetooth Setting

Includes Bluetooth On and Off, device name, pairing code, Bluetooth state, etc.

To enter Setup interface:

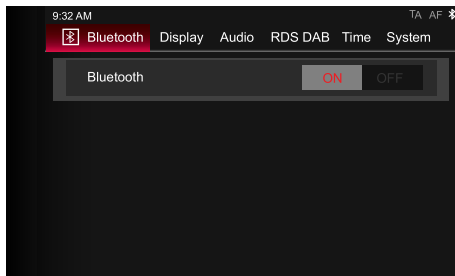

- Touch [Bluetooth] under [Setting] in the main interface, and enter the Bluetooth Setting interface. Touch [ON] to open the Bluetooth function.

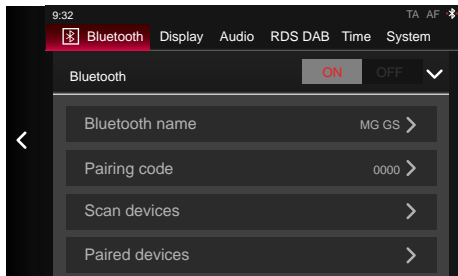

AIR CONDITIONING AND AUDIO SYSTEMS

- The default name displayed in the system is MG GS, the default pairing code is 0000, and the device name and pairing code can be modified.



- When Bluetooth is not turned on, the status bar does not display Bluetooth icon. When Bluetooth is turned on with no no device connected, the status bar displays . When Bluetooth is turned on with a device connected, the status bar displays .

Setting Bluetooth Name

Touch [Bluetooth Name], you can set the Bluetooth name in the interface to your preference.

Setting Pairing Code PIN

Selecting [Pairing Code] will allow the PIN to be changed to the owner's requirements.

AIR CONDITIONING AND AUDIO SYSTEMS

Pairing with a Mobile Phone

The system searches for available devices nearby which feature Bluetooth technology and are ready to connect, after the devices are found, they are displayed in the list.

- 1 In the Bluetooth Setting interface, touch [Scan for Devices], and then touch [Scan].
- 2 After the scanning is successfully performed, the scanned device names will appear in a list. If no device is found initially, you can touch [Scan Again].
- 3 After the completion of scanning, touch [Connect] following the device name. A message prompting you to enter the pairing code appears.

- 4 Use the mobile phone to input the pairing code of the entertainment system.

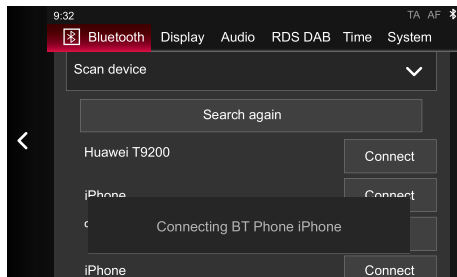

After the connection is successful, a message prompting connection completion appears.

AIR CONDITIONING AND AUDIO SYSTEMS

Pairing from Mobile Phone

Turn on the system Bluetooth function, request the connection from mobile phone end for pairing with the mobile phone.

- 1 Turn on the Bluetooth function on the mobile phone and search the entertainment system for pairing.
- 2 If the mobile phone asks you to enter the pairing code, enter the pairing code set in the entertainment system.
- 3 After the pairing is completed, the message prompting connection completion appears. If the pairing fails, please repeat the procedure described above.

Phone Book Synchronisation

When the system and mobile phone Bluetooth are connected, the system will automatically synchronise the contacts in the mobile phone into the system.

Note: *The function of deleting contacts in Bluetooth phone book is not supported.*

Note: *For some mobile phones, a dialog box asking whether to synchronise the phone book will pop up before synchronisation of contacts.*

Note: *Since the system temporarily does not support some commercially available mobile phones, the case of no synchronisation of Bluetooth phone book will occur on non supported phones.*

Note: *New contacts that are added will not be displayed until the next synchronisation is carried out.*

Phone Menu

Touch the Bluetooth Phone area in the main interface to enter the Bluetooth Phone menu, including Contacts, Call Log and Keypad.

AIR CONDITIONING AND AUDIO SYSTEMS

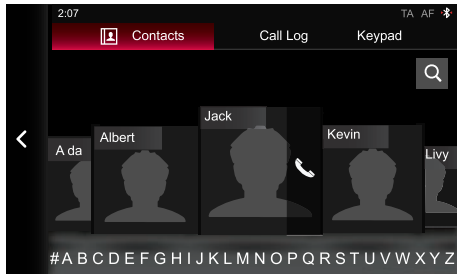

Contacts

Touch the Bluetooth Phone area in the main interface, and then touch [Contacts] to enter the Contacts interface.

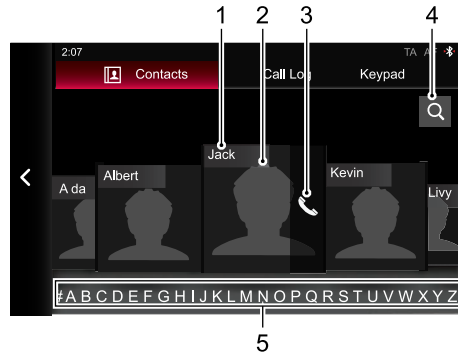

1 Contact Name

2 Contact Photo

Touch the photo to view the contact's details.

3 Make a Phone Call

2

AIR CONDITIONING AND AUDIO SYSTEMS

- 4 Search a Contact
- 5 Quickly Search a Contact

Call Log

Touch the Bluetooth Phone area in the main interface, and then touch [Call Log] to enter the Call Log interface.

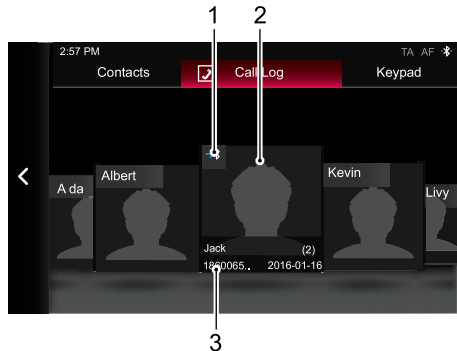

1 Call History Type

Bluetooth Dialed: 

Bluetooth Answered: 

AIR CONDITIONING AND AUDIO SYSTEMS

Bluetooth Missed: 

2 Contact Photo

Touch the photo to view the detailed call history of the contact.

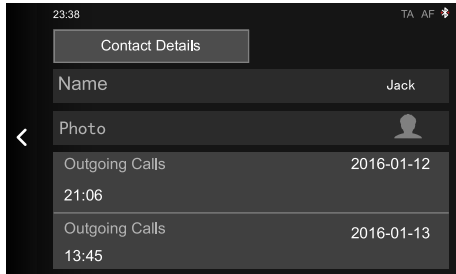

3 Contact name, call duration, contact details

Touch to call this contact.

Keypad

Touch the Bluetooth Phone area in the main interface, and then touch [Keypad] to enter the Keypad input interface.

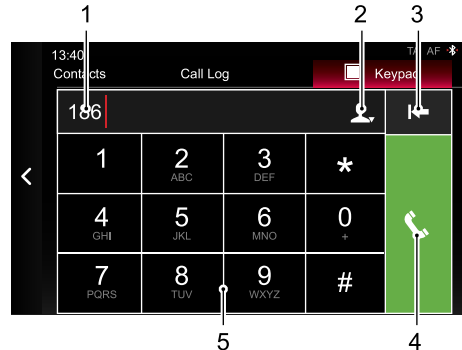

1 Input Box

You can input the phone number or initial letter of a contact name to be dialed.

2 Matching a Contact

AIR CONDITIONING AND AUDIO SYSTEMS

In the process of entering a phone number, the system will match the number with a contact in the Contacts immediately. This icon will appear when there is a matching result, touch it to display the following interface. Touch it again to retract the matching result.

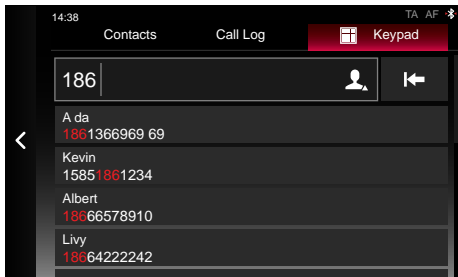

3  Backspace/Delete Button

4 Make a Phone Call

5 Numeric Keypad Area

You can input numbers and symbols, long press 0 to input a + sign.

Make a Phone Call



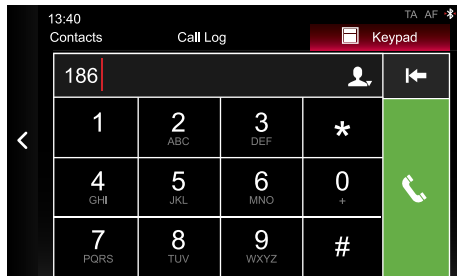

Keypad Input

- 1 Enter the Bluetooth Phone interface, touch [Keypad] to enter the Keypad input interface, and input the phone number or initial letter of the contact name in the text box.



- 2 Touch numerical keys to input the phone number or initial letter of a contact name to be dialed. When the initial letter is input, the input box will display the dial figure number instead of the letter.

AIR CONDITIONING AND AUDIO SYSTEMS

- 3 In case of input error, touch , the input number figures will be deleted one by one. Long press the button to delete all of the figures.
- 4 In the process of entering a phone number, the system will match the number with a contact in the Contacts immediately, and  will appear when there is a matching result. Touch this icon to see the matched contacts, and touch again to retract the matching result.
- 5 Touch  and make a phone call through Bluetooth.
- 6 Touch  to end the call.

Dial a Number in Call History

- 1 Enter the Bluetooth Phone interface, and then touch [Call Log] to enter the Call Log interface.

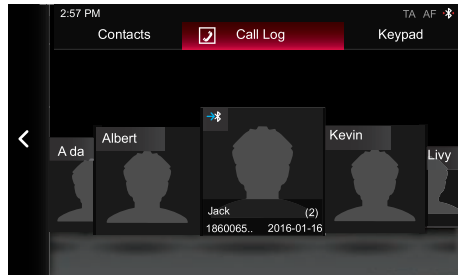

- 2 Touch the contact name or number at the bottom of the contact photo, you can call the contact.

AIR CONDITIONING AND AUDIO SYSTEMS

Dial a Number in Contacts

Enter the Bluetooth Phone interface, and then touch [Contacts] to enter the Contacts interface.

Contacts Synchronization

When the entertainment system and mobile phone Bluetooth are connected, the system will automatically synchronize the Contacts in the mobile phone into the system.

Enter the Bluetooth Phone interface, and then touch [Contacts]. The contacts in the mobile phone will appear.

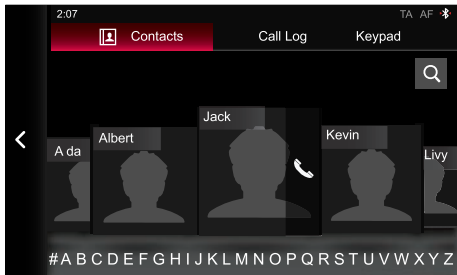

The contacts synchronized through Bluetooth support voice dialing and quick search, but do not support Delete Contacts function.



Note: *Since the system temporarily does not support some commercially available mobile phones, the case of no synchronisation of Bluetooth phone book will occur on non supported phones.*

Quick Search

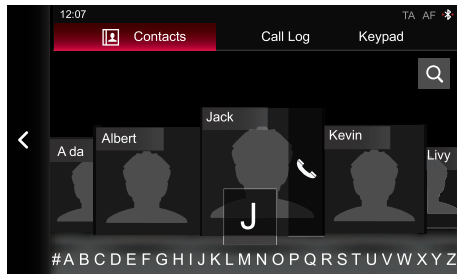
Touch letters below the [Contacts] interface to quickly locate the contacts with this letter as the initial letter.



AIR CONDITIONING AND AUDIO SYSTEMS

Touch  in the interface, input the initial letter of the name to be searched or input the name to search, after the search is completed, touch  to make a phone call.

Calling the Entry in “Contacts”

Directly touch right side of contacts in the [Contacts] interface  to make a phone call.

When the contact has multiple contact information, first select a phone number, and then make a call.

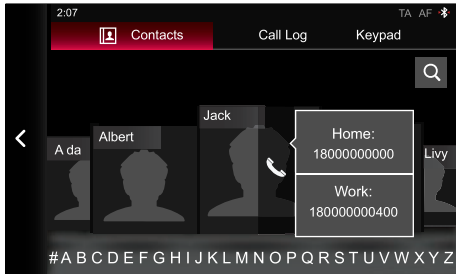

Or touch the contact photo to enter the Contact Details interface, and touch  to make a phone call.

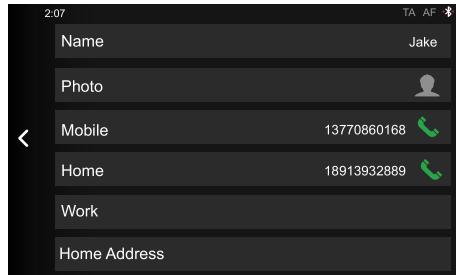



Dial from Mobile Phone

- 1 Turn on the mobile phone Bluetooth to match the entertainment system.
- 2 Select a contact in the mobile phone and dial.

AIR CONDITIONING AND AUDIO SYSTEMS

Other Functions

During a call, touch  to display the dial pad which may be used for entering extension number, etc. Touch  again to close the dial pad.

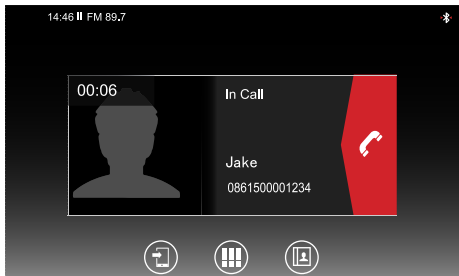

Incoming Call

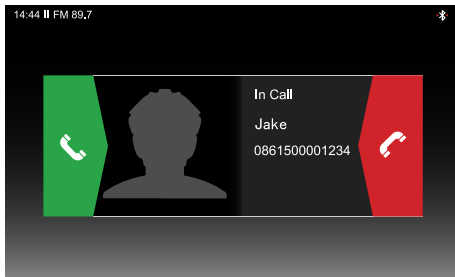

Answer a Call

- In the main system interface or full screen picture of an incoming call, touch  or swipe to the right to answer the call.



- In an incoming call state, short press  on the steering wheel to answer the call.
- You may also select to answer the call with the mobile phone.

Reject a Call

- In the main system interface or full screen picture of an incoming call, touch  or swipe to the left to reject the call.
- In an incoming call state, long press  on the steering wheel to reject the call.
- You may also select to reject the call with the mobile phone.

Switching to Private Mode

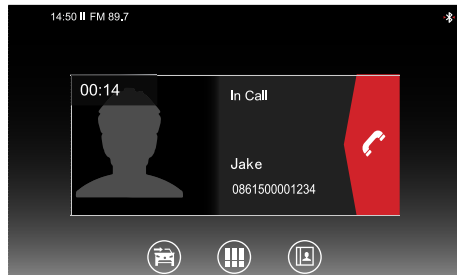

During the call, touch  to enter the Private mode.

Touch  to restore the hands-free calling.

In the Private Mode, the mobile phone can be used for calling; the speakers and microphone of the entertainment system will be muted. But the connection via Bluetooth pairing will remain.

AIR CONDITIONING AND AUDIO SYSTEMS

Adjusting Phone Voice Volume

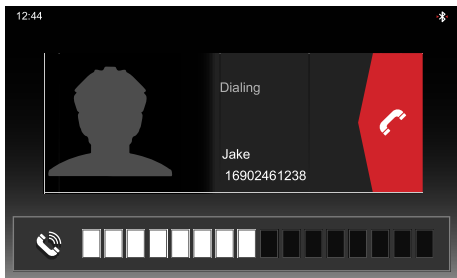

During a call, rotate the volume adjustment knob or press the volume adjustment button on the steering wheel control button to adjust the phone voice volume.

Entertainment

Instructions

USB/AUX Instructions

- The USB port supports U disc music, iPod connection and MirrorLink connection, providing 1 ampere charging current.
- The AUX port supports AUX audio/video input.

Precautions for Playback Storage Media Mode

- This system supports U disc, Bluetooth, iPod and AUX storage media.
- If the USB device, iPod® or AUX media is not in use, DO NOT leave the device connected. This may result in connection deterioration.
- Do not remove USB device or iPod® whilst media is playing. Failure to follow these instructions could result in corrupted data.
- Keep the USB port dry and free from debris. The port will become unusable if it is blocked.

Radio

Touch [Radio] after touching multimedia widget in the homepage to enter the radio playback interface.

To listen to the broadcasting of different bands, touch [FM], [AM] or [DAB] in the playback interface to switch between radio bands and DAB.

AIR CONDITIONING AND AUDIO SYSTEMS

FM/AM

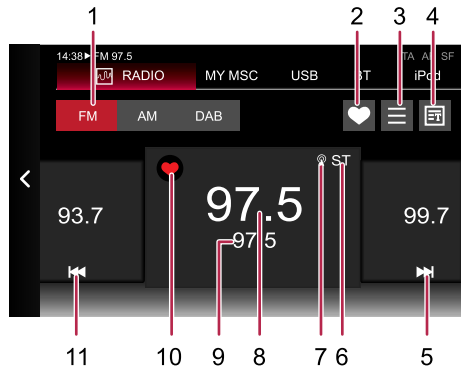

- 1 FM, AM, DAB selection
- 2 Favorite stations list
- 3 Station list
- 4 Radio text
- 5 Station search

Short press: Next station.

Long press: Search for a station between the current station and the next station.

6 Stereo indicator

When playing a mono broadcast, ST goes out. When the stereo broadcasting signal is stable, ST illuminates. When the stereo broadcasting signal is unstable, ST flashes.

7 Stereo signal strength

8 Station name

9 Station frequency

Touch[Station Frequency], can play/pause the stations.

10 The Favorite Stations indicates that the station has been added to Favorites, and indicates that the station is not added to Favorites

11 Station search

Short press: Previous station.

AIR CONDITIONING AND AUDIO SYSTEMS

Long press: Search for a station between the current station and the previous station.

DAB

In the radio playback interface, touch [DAB] to enter DAB interface.

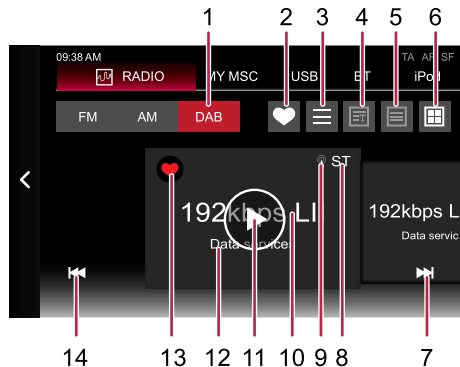



- 1 FM, AM, DAB switching
- 2 Favorite stations list
- 3 Station list

AIR CONDITIONING AND AUDIO SYSTEMS

- Radio text or slide show (where transmitted)
- Electronic programme list - EPG (if available)
- Station Category
- Next station
- Stereo broadcasting ID

When playing a mono broadcast, ST goes out. When the stereo broadcasting signal is stable, ST illuminates. When the stereo broadcasting signal is unstable, ST flashes.

- Signal strength ID
- Station name
- Mute
- Service following indicator (if applicable)
- The Favorite Stations  indicates that the station has been added to Favorites, and  indicates that the station is not added to Favorites
- Previous station

Station List

Touch  to enter the list of stations interface, a list of available stations is displayed.

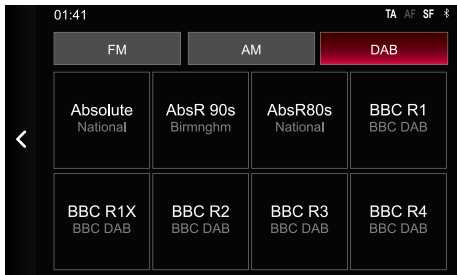

Radio Text

Touch  for station information, to hide the station information, touch this icon again.

AIR CONDITIONING AND AUDIO SYSTEMS

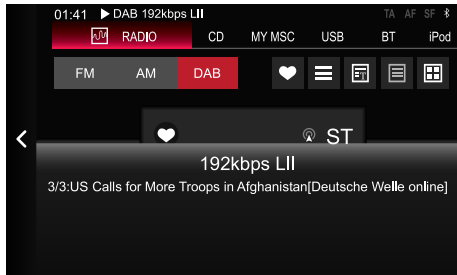

Electronic Programme Guide - EPG (if available)

In the DAB interface, touch  for the list of programs available on that station.

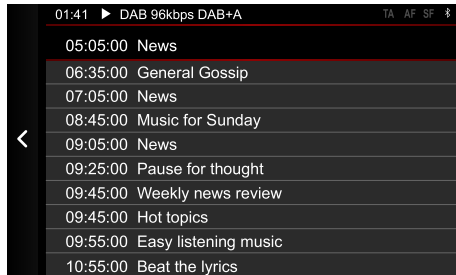

Station Category

In the DAB interface, touch  for the stations of different type.

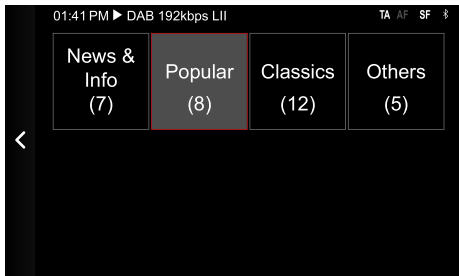

AIR CONDITIONING AND AUDIO SYSTEMS





- Touch , and the stations will repeat playing automatically. When you hear a desired station, touch the station page to stop auto playback and start to play this station.

Selecting a Station

When using the radio for the first time, the radio will perform FM, AM full-band scanning automatically, and all stations are saved to the list of radio stations.

- Touch  to switch to previous station, and touch  to switch to next station. You can also swipe to the left or right on the interface to switch between the stations.

Long press  or  to search stations between the current station and next station in the list.

- Touch  to view and play the stations already in Favorites.

AIR CONDITIONING AND AUDIO SYSTEMS

Reminders

In the main radio interface, press the [MENU] button on the system control panel, touch 'Reminders' to enter the reminders list, you can add, delete or modify the reminder list.

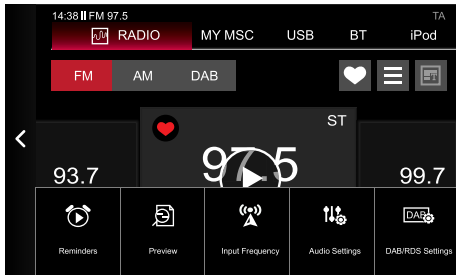

In the station list interface, stations can be added, modified or deleted, touch **+** to add to the reminders, the system will alert the driver before switching to the reminders (if alert switched on).

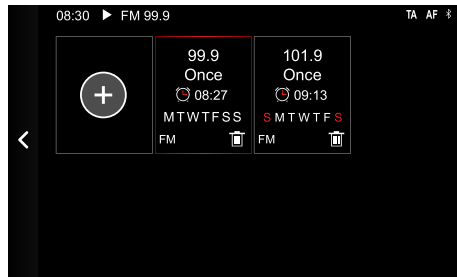

AIR CONDITIONING AND AUDIO SYSTEMS

Reminder setting include:

- Alert
Alert driver of imminent station change.
- Repeat
Switch on to repeat the event more than once.
- Station
Selects the required station.
- Date/Time
Allows the setting of the day/time for reminders.

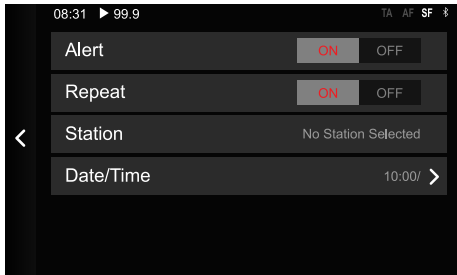



With the reminders set, the system will alert you prior to playing the selected station. Select Yes/No accordingly.



AIR CONDITIONING AND AUDIO SYSTEMS

Search Stations

There are three ways to search for stations.

- Touch  to perform full-band scanning.
- When the radio is playing, long press  or  to perform band scanning between the current playing station and previous station or next station in the station list. If a new station is found, the system will automatically store it to the station list.

- Press MENU in the entertainment panel, and select a input frequency to enter the Station Search interface. Input a station frequency such as FM 101.1, AM 531 into the input box to search for the desired station.

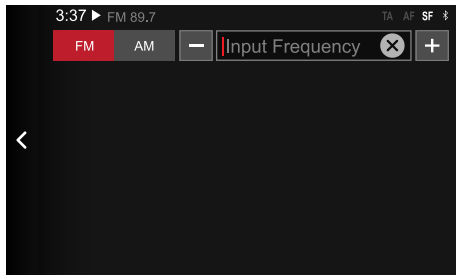

AIR CONDITIONING AND AUDIO SYSTEMS

Playing Audio Files

This system supports MP3, WMA, AAC, OGG, ID3 Tag info, WAV, APE and FLAC audio files.

Note: Due to differences in the compression ratio and bit rate of the multimedia formats downloaded from the Internet and other factors, it may not be possible to decode and play all files, the quality may vary.

Favorite Music

Touch the radio/music widget in the main interface, and touch [MY MSC] to enter the Favorite Music playback interface.

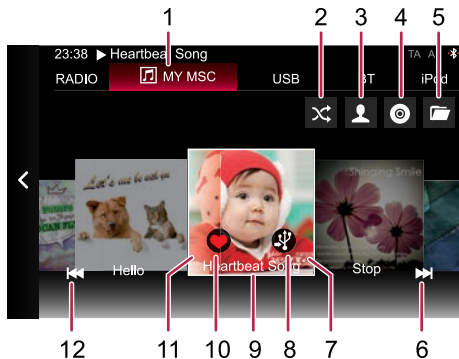

1 Music Playback Media Selection

Music playback of different storage media may be selected.

AIR CONDITIONING AND AUDIO SYSTEMS

2 Playback Mode

You can switch between track playback modes, including: Single Loop, Random Play, Play All.

3 Artist Search

Enter the Artist Search interface, and enter the artist name to search.

4 Album Search

Enter the Album Search interface, and enter the album name for a search.

5 Favorites List

Enter the Favorite Music Collection interface, and touch the collected music for direct playback.

6 ►► Next

Short press to switch to the next track. Long press to fast forward in the current track, and release the button to start playback.

7 Album Cover

It is the album cover (if data available) of currently playing song, touch album cover to pause/play the current song.

8 Add Music to USB Disc

Add the favorite music being played to the USB disc. The music cannot be added if no USB disc is connected.

9 Song Title/Artist

10 Song Already Added to My MSC (My Music)

Touch to remove the song from My MSC (My Music).

11 Track Playback Progress

Display the track playback progress by the gradient effect of the album image.

12 ◀◀ Previous

Short press to return to previous track. Long press for fast rewind in the current track, and release the button to start playback.



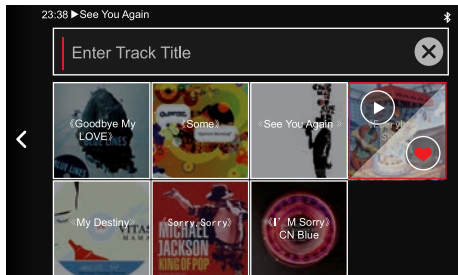

AIR CONDITIONING AND AUDIO SYSTEMS

Favorites List

On the Favorites playback interface, touch  to enter Favorites List interface.



Touch the input box, and enter the keyword to search for a song.

Touch the song cover (if there is no cover, the default cover image is displayed),  and  appear on the cover. Touch  to play that song.  indicates that the music has been added in the My MSC, and touch to remove it from the My MSC.

USB Music

Touch the radio/music widget in the main interface, and touch [USB] to enter the USB Disc Music playback interface.



1 Music Playback Media Selection

Music playback of different storage media may be selected.

AIR CONDITIONING AND AUDIO SYSTEMS

2 Playback Mode

You can switch between track playback modes, including: Single Loop, Random Play, Play All.

3 Artist Search

Enter the Artist Search interface, and enter the artist name to search.

4 Album Search

Enter the Album Search interface, and enter the album name for a search.

5 U Disc Folder List

Enter the U Disc Folder interface, touch to enter the folder, and select and play the music you want to hear.

6 ►► Next

Short press to switch to the next track. Long press to fast forward in the current track, and release the button to start playback.

7 Album Cover

It is the album cover (if data available) of currently playing song, touch album cover to pause/play the current song.

8 Song Title/Artist

9 Add Music to My Favorites

Touch to add the current music to my favorite list.

10 Track Playback Progress

Display the track playback progress by the gradient effect of the album image.

11 ◀◀ Previous

Short press to return to previous track. Long press for fast rewind in the current track, and release the button to start playback.

AIR CONDITIONING AND AUDIO SYSTEMS

U Disc Folder List

On the U disc music playback interface, touch  to enter the U Disc Folder List interface.

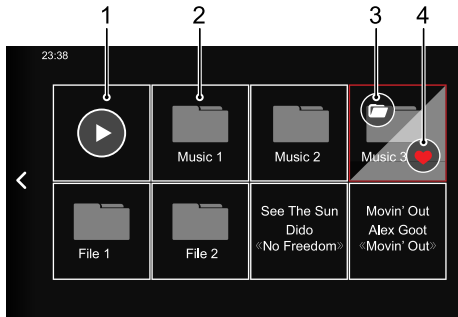

- 1 All music in this folder will be played.
- 2 Indicates the folder contains a sub folder.
- 3 Opened folder.
- 4 Add to, or remove from favorites (entire folder).

Bluetooth Music

To play music via Bluetooth, firstly connect the Bluetooth device. (See the 'Bluetooth Pairing and Connection' section for details)

After the Bluetooth device is connected with the system, touch the radio/music widget on the main interface, and then select [BT] to enter the Bluetooth music playback interface.

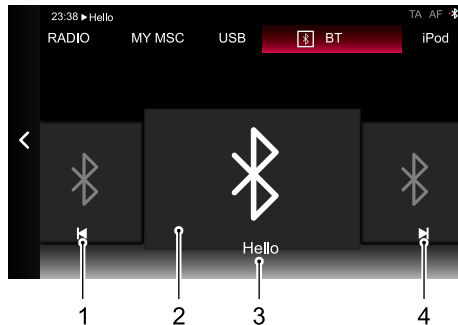

AIR CONDITIONING AND AUDIO SYSTEMS

- 1 Switch to the Previous Track
- 2 Bluetooth Music Default Image
- 3 Name of Song Artist
- 4 Switch to the Next Track

In the Bluetooth music playback interface, press [MENU] button on the panel, and the [Bluetooth Settings] and [Audio Settings] appear on the interface.

Touch [Bluetooth Settings], and the system skips to the Bluetooth Settings interface.

Touch [Audio Settings], and the system skips to the Audio Settings interface.

iPod Music

Touch the radio/music widget in the main interface, and touch [iPod] to enter the iPod Music playback interface.

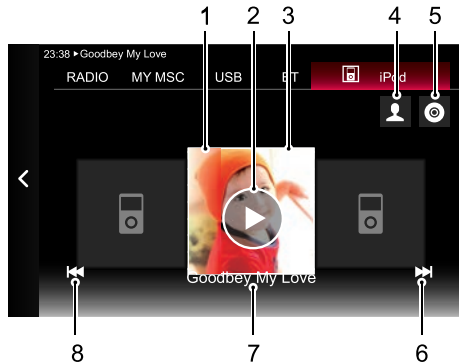

- 1 Track Playback Progress
- 2 Play/Pause
- 3 Album Cover

AIR CONDITIONING AND AUDIO SYSTEMS

- 4 Artist Search
- 5 Album Search
- 6 Switch to Next Track
- 7 Song Title/Artist
- 8 Switch to Previous Track

Video Playback

The system supports WMV, ASF, H264, MPEG2, MPEG4 and HD Video Playback video files.

Note: *Due to differences in the compression ratio and bit rate of the multimedia formats downloaded from the Internet and other factors, it may not be possible to decode and play all files, the quality may vary.*

Note: *For your driving safety, when the vehicle speed is greater than 10 mph (15 km/h), the video safety mode will be activated automatically, and the video cannot be played at the moment.*

Note: *The video cannot be played during a call.*

AIR CONDITIONING AND AUDIO SYSTEMS

Touch the video widget on the main interface to select different devices: [USB], [iPod]. Enter the video list, and touch a single video to play.

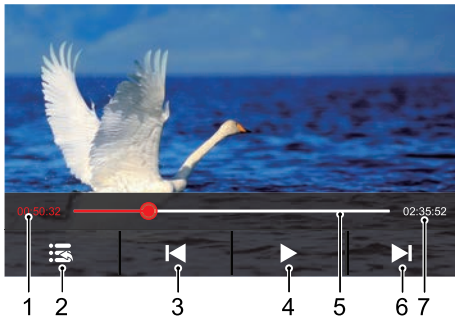

- 1 Current Elapsed Time
- 2 Return to Playlist
- 3 Previous Video
- 4 Play/Pause
- 5 Playback Progress Bar

Drag the progress bar forward or backward to directly return or skip to certain playing point.

- 6 Next Video
- 7 Total Duration

AIR CONDITIONING AND AUDIO SYSTEMS

AUX Playback

Touch AUX widget on the main interface to enter AUX application, and connect AUX to play AUX audio or video.

Picture Browsing

Insert USB storage device into USB interface, and the system will automatically load the pictures on the storage device.

Touch the picture browsing widget on the main interface to enter the picture browsing application. The entertainment system will display folders in the storage device.

Touch to enter the folder, and touch the picture. The picture will be displayed on the interface.

Picture Browsing Interface

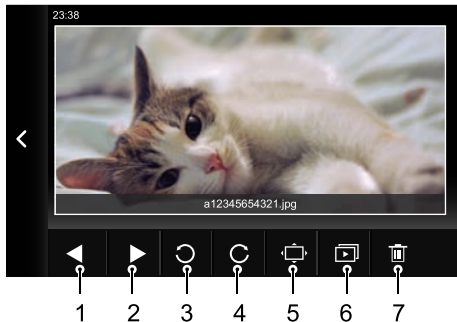

- 1 Previous Picture
- 2 Next Picture
- 3 Counterclockwise Rotating a Picture
- 4 Clockwise Rotating a Picture
- 5 Full-screen Picture Browsing
- 6 Slide Play
- 7 Deleting a Picture

7 Deleting a Picture

Note: The system supports the viewing of pictures stored on a USB device. Due to differences in picture resolution, format compression ratio and some other factors not all pictures may be decoded and displayed.

Note: Swipe to the left or right on the screen to switch to the next or previous picture.

AIR CONDITIONING AND AUDIO SYSTEMS

Air Conditioning - A/C

Touch the A/C widget on the main interface to enter the A/C control and display interface. Refer to "Automatic Temperature Control" for details.

Note: If the A/C control panel and the entertainment system A/C interface are operated simultaneously, the pressing operation of the A/C control panel will take the priority.

Vehicle-Mobile Phone Interconnection (MirrorLink)

The MirrorLink function allows bilateral control of a suitable mobile phone through the entertainment system. Available functions including answering/making calls, listening to music on the mobile phone, navigation on the mobile phone, etc., and direct operation through the mobile phone is also possible.

Note: Only phones with the MirrorLink function will achieve connection to the entertainment and navigation system via this feature. Currently, some brands of mobile phones such as HTC, SONY, LG, SAMSUNG and Nokia have the MirrorLink function. For details, consult mobile phone dealers.

- 1 Confirm that the mobile phone has the MirrorLink function activated.
- 2 Use a USB connecting wire to connect the mobile phone with the entertainment USB socket.
- 3 Touch [MirrorLink] in the homepage. After the vehicle and mobile phone are successfully connected, the

applications on the mobile phone can be operated using the onboard system.

- 4 If a mobile phone application supports the landscape display mode, it will be automatically converted into landscape in the system; otherwise, the original portrait mode is maintained, and the application is scaled in equal proportion.
- 5 Press the [MENU] key on the panel to choose [Back], [Menu], [Home], etc.

AIR CONDITIONING AND AUDIO SYSTEMS

Vehicle Setting

Touch the vehicle settings widget on the touch main interface to enter the vehicle settings interface.

Locking

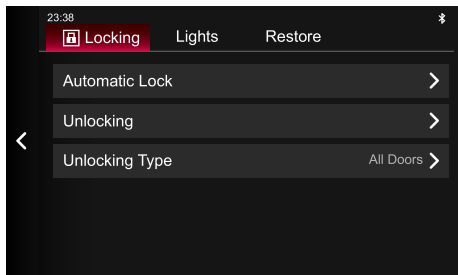

Automatic Lock

Enable or disable the automatic lock function as required.

Unlocking

Enable or disable the auto unlocking function as required.

Unlocking Type

Choose "Driver Door Only" or "All Doors" as required.

Lights

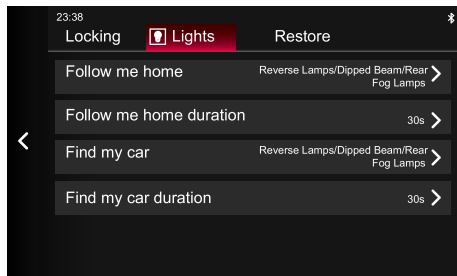

Follow Me Home

Activate or deactivate the follow me home function. Allows the driver to choose [Reverse Lamps], [Dipped Beam] or [Rear Fog Lamps].

Follow Me Home Duration

Choose [Follow me home duration] to set the duration of follow me home lighting. The chosen range is from 30 seconds to 5 minutes, with the increment of 30 seconds and the default duration of 1 minute.

Find My Car *

When using the remote control to unlock the car, this function automatically illuminates the selected lights for a chosen time period. This can help the driver find his vehicle in a congested parking lot. Allows the driver to choose [Reverse Lamps], [Dipped Beam] or [Rear Fog Lamps].

Find My Car Duration *

Choose [Find my car duration] to set the duration of the find my car lighting. The chosen range is from 30 seconds to 5 minutes, with the increment of 30 seconds and the default duration of 1 minute.

Restore

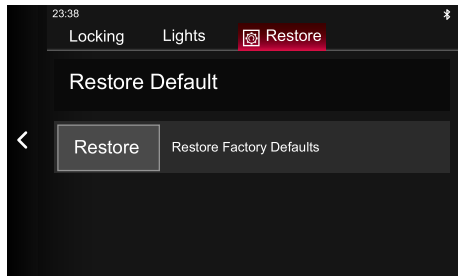

Touch [Restore] to access this function so that "Restore Factory Defaults" appears, then touch [Restore] so that the prompt "Do you want to restore factory settings?" appears , and choose "Yes" or "No" as required.

AIR CONDITIONING AND AUDIO SYSTEMS

Settings

Touch the settings widget on the main interface to enter the settings interface.

Bluetooth Settings

Touch [Bluetooth] to enter the Bluetooth settings interface. For details see "Bluetooth Phone" in this chapter.

Display Settings

Touch [Display] to enter the display settings interface, and you can set the display on the interface according to your requirements.

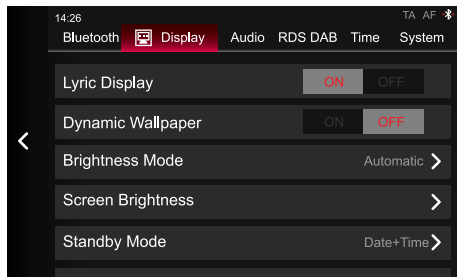

Lyric Display

Touch [Lyric Display] to turn on/off the lyric display of the songs.

Note: *Not all radio stations/music formats have the capability to display song lyrics.*

Dynamic Wallpaper

Touch [ON] or [OFF] in the dynamic wallpaper area to turn On/Off the dynamic wallpaper function. After the dynamic wallpaper function is switched on, the wallpaper displayed in the main interface changes with time. If this function

is switched off, the wallpaper of the main interface will be displayed in the static state.

Brightness Mode

Touch [Brightness Mode], and choose [Night], [Day] and [Automatic] to adjust the screen brightness as required.

Screen Brightness

Touch [Screen Brightness] to adjust the backlight brightness of the screen. Touch **+** to increase brightness, or touch **-** to decrease brightness.

Standby Mode

Touch [Standby Mode], and set the display mode in standby by choosing [Date + Time] or [Clock].

Screen Calibration

Touch [Screen Calibration] to open a pop up window asking if you wish to 're-calibrate' the screen. Touch [Yes] to calibrate the screen accuracy.

Touch each cursor centre [+] when it appears to calibrate the screen. The data is automatically saved.

AIR CONDITIONING AND AUDIO SYSTEMS

Audio

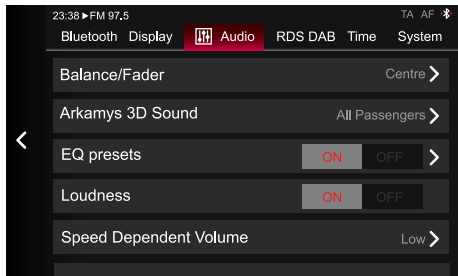

Touch [Audio] on the settings interface to enter the audio settings interface.



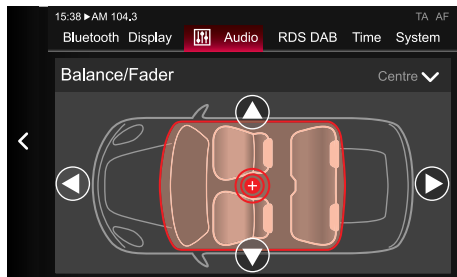

Balance/Fader

Touch [Balance/Fader], and enter the balance interface. You can choose a balance setting that provides an ideal listening environment in all occupied seats.



Touch  or  to adjust front/rear speaker balance.

Touch  or  to adjust left/right speaker balance.

AIR CONDITIONING AND AUDIO SYSTEMS

Arkamys 3D Sound

You are able to turn the Arkamys 3D sound effect function on/off, when switched on you are able to select to whom the function should be directed toward, all passengers or driver.

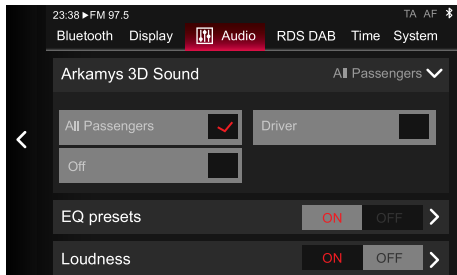

EQ Presets

The object adjusted by the equaliser is the frequency characteristic of the speaker output audio signal, when the equaliser is OFF, the frequency characteristic is the most recent setting by default. When the equaliser is ON, you may select from several preset settings or customise the

sound according to personal preference to meet different auditory demands.

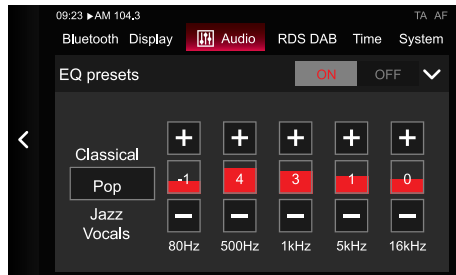

The preset equalizer has 6 options: Classical, Pop, Jazz, Vocals, Rock, and Custom.

Touch **+** or **-** to adjust the preset equalizer curve.

When the value of any band of the equalizer is being changed, custom is automatically highlighted, which indicates that it is selected. When you exit the equalizer settings, the settings are automatically saved.

Note: The equaliser only works on media-type audios.

AIR CONDITIONING AND AUDIO SYSTEMS

Loudness

Touch [Loudness], when the loudness compensation is turned on, it can compensate for deficiencies in the bass and treble ranges at low volume.

Speed Dependent Volume

Touch [Speed Dependent Volume], and you can select from 4 options: Off, Low, Normal, High. Touch your selection as required, or the function can be switched off.

Volume

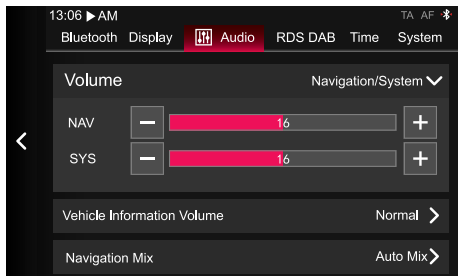

Set the volume of the navigation and system prompts respectively according to personal preference. Touch **+** to increase the volume, and touch **-** to decrease the volume.

Vehicle Information Volume

Touch [Vehicle Information Volume], and set the chime volume by choosing [Normal] and [Loud].

Navigation Mix

Touch [Navigation Mix], and choose [Auto Mix] or [Direct Mix] as required.

Call Ringtone

Touch [Call Ringtone] to choose the ring tone of incoming calls.

Start Up Audio

Touch [Start Up Audio] to turn on/off the start up audio.

Touch Tone

AIR CONDITIONING AND AUDIO SYSTEMS

Touch [Touch Tone] to turn on/off the key tones beyond the dialing keypad.

Dialpad Touch Tone

Touch [Dialpad Touch Tone] to turn on/off the touch sound when using the dialpad keys only.

RDS DAB

In the settings interface, touch [RDS DAB], and enter the RDS DAB settings interface.

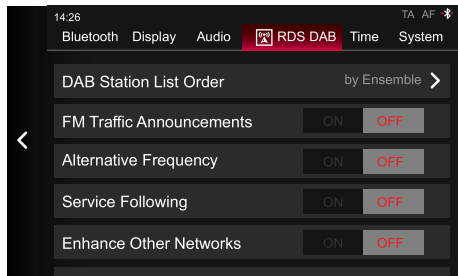

- 1 Touch [DAB Station List Order] to select the way in which the station list is sorted and displayed.

Touch [by Ensemble] to sort the station list by ensemble name and then stations in alphabetical order.

Touch [by Station] to display the station list in alphabetical order.

AIR CONDITIONING AND AUDIO SYSTEMS

- 2 Touch [FM Traffic Announcements] to turn on/off the TA function.

Selecting TA [On] allows the system to analyse and communicate traffic messages to the driver. This information may be in the form of voice messages.

Select [Off] to inhibit traffic announcements.

- 3 Touch [Alternative Frequency] to turn on/off the AF function.

AF is alternative frequency , when the signal is below a certain level, AF will automatic search for an alternative frequency of the current station if the current station supports this function.

- 4 Touch [Service Following] to turn on/off the Service following function.

Service Following is the term applied to maintaining the same audio or data content that the user has selected in varying reception conditions if the current station supports this function.

AIR CONDITIONING AND AUDIO SYSTEMS

- 5 Touch [Enhanced Other Networks] , can select LO or DX states.

EON - Enhanced Other Networks enables the system to obtain information from other networks as well as the one selected. Select LO for Local or DX for networks further afield.

- 6 Touch [Regional] to turn on/off the Regional tracking mode function.
- 7 Touch [DAB Announcements] , there are 11 Announcements types to choose from.
Touch the check box to select.

Time

On the setting interface, touch [Time] to enter the time and date settings interface.

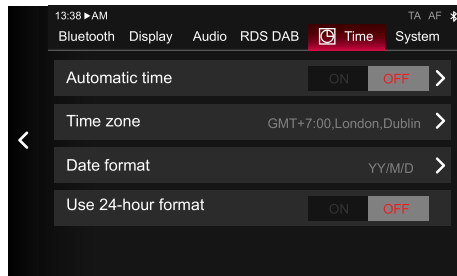

Date

Date setting is available.

Time

Time setting is available.

AIR CONDITIONING AND AUDIO SYSTEMS

Date Format

The system provides several date formats, including D/M/YY, M/D/YY and YY/M/D.

Use 24 - Hour Format

Touch [Use 24–Hour Format], and select to turn on/off 24 hours format according to your preference.

System

Touch [System] on the setup interface to enter the system settings interface, where you can view and set some basic states and functions of the system.

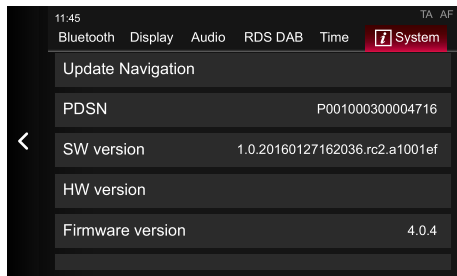

You can update navigation, view PDSN, SW version, HW version, firmware version, Bluetooth MAC, iPod MAC, MCU software version, and MBSN.

Setting Reset

Touch [Setting reset] on the system settings interface to open the dialogue box "Restore default settings?" .

Touch [Yes], and the system automatically restores.

After default settings are restored, all the user modified items in the system settings are restored to default settings upon delivery, user data in the device will not be deleted, please use with caution.

Factory Reset

Touch [Factory reset] on the system settings interface to open the dialogue box "Delete all user data?" .

Touch [Yes], and the system automatically deletes the user data.

After the user data is deleted, all the user modified items in the system settings are restored to default settings upon delivery, all the user data except the navigation map in the device will also be deleted, please use with caution.

Seats & Restraints

148 Seats

154 Seat Belts

*164 Airbag Supplementary Restraint
System*

173 Child Restraints

SEATS & RESTRAINTS

Seats

Overview



To avoid personal injuries due to the loss of vehicle control, do not adjust the seats while the car is moving.

The car is equipped with 6 -way or 4 -way adjustable front seats and independent rear seats.

An ideal position of the seat should make sure your driving position is comfortable, which allows you to hold the steering wheel with your arms and legs slightly bent and control all the equipment. Take care when adjusting the height of the front seat - the feet of the rear passenger could become trapped when the seat is lowered.

Do Not incline the front-seat backrest too far to the rear. Optimum benefit is obtained from the seat belt with the backrest angle set to approximately 25° from the upright (vertical). The driver and front passenger seats should be positioned as far rearward as practical. A properly adjusted seat helps reduce the risk of injury from sitting too close to an inflating airbag.

Head Restraints



Adjust the height of the head restraint so that the top of it is in line with the top of the occupant's head. This location may reduce the risk of head and neck injuries in the event of a collision. Do not adjust or remove the head restraints while the car is moving.



Do not hang anything on any head restraint or head restraint rod.

The head restraint is designed to prevent rearward movement of the head in the event of a collision or emergency braking, thereby reducing the risk of head and neck injuries.

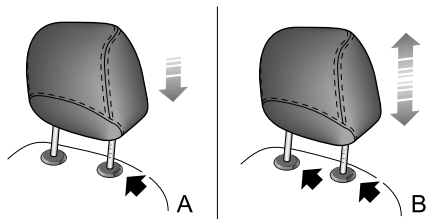

and press the head restraint downward; release the button after it reaches the desired position, and gently press the head restraint downward to make sure that it is locked in position. To move the head restraint to the lowest position, press and hold the guide buttons (shown by Figure B) at both ends of the head restraint simultaneously, and press the head restraint downward.

3

There are 3 positions to adjust the height of the seat head restraint.

When adjusting the head restraint from a low position to a high one, pull the head restraint directly upward, and gently press the head restraint downward after it reaches the desired position to make sure that it is locked in position. To remove the head restraint, press and hold the guide buttons (shown by Figure B) at both ends of the head restraint simultaneously, and pull the head restraint upward to remove it.

When adjusting the head restraint from a high position to a low one, press the left guide button (shown by Figure A),

SEATS & RESTRAINTS

Manual Seat Adjustment *

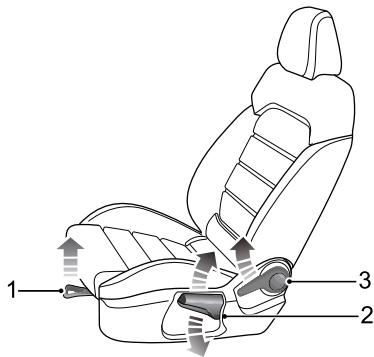

1 Forward/rearward adjustment

Lift the lever (1) under the seat cushion, slide the seat into an appropriate position, release the lever to make sure that the seat is locked in position.

2 Height adjustment *

Lift the lever (2) repeatedly to raise the seat cushion, and press the lever downward to lower the seat cushion.

3 Backrest adjustment

Lift the lever (3), adjust the backrest until it moves into a satisfiable position, release the lever.

Power Seat Adjustment *

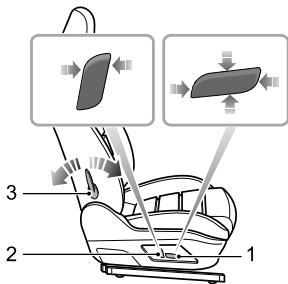

1 Forward/rearward adjustment

Push the switch (1) forward or backward to move the seat forward/backward.

2 Cushion height

Pull the switch upward or push downward (1) to raise or lower the seat cushion.

3 Backrest adjustment

Move the switch (2) forward/backward to adjust the backrest until it reaches the desired angle.

4 Lumbar support adjustment

Move the lever (3) to adjust the hardness of the lumbar support.

Front Seat Heating *



If bare skin is in contact with the heated seats for excessive periods of time it may cause burns.

The seat cushion and backrest are provided with heating elements. With the engine running, press the corresponding heating switch to activate the seat heating function and heat the seat.

SEATS & RESTRAINTS

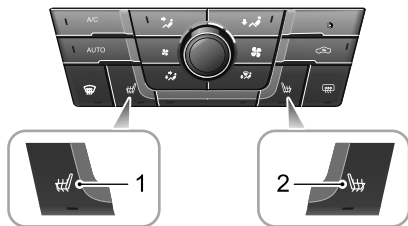

- 1 Front passenger seat heater switch
- 2 Driver seat heater switch

When pressing a seat heater switch, the corresponding seat will become warm. Press the switch again to stop the heating function. When the seat heating function is activated, the operating indicator in the switch illuminates. When the temperature reaches approximate 42°C, the heating function will be deactivated automatically.

IMPORTANT

- Do not cover the heated seats with blankets, cushions or other insulation type objects or materials.
- If the seat is heated up to 42°C and continues getting hotter when using seat heating system, please turn off seat heating and contact MG Authorised Repairer.
- Overuse of the driver's heated seat may cause drowsiness and could affect safety.

Rear Seats

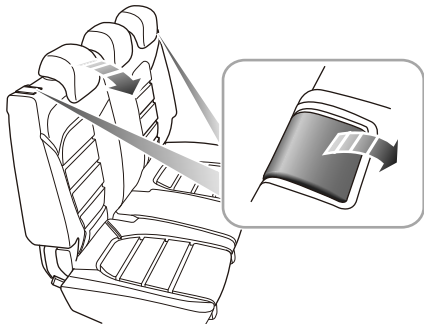

Adjustment of Rear Seat Backrest

Pull up the control lock lever at the top of the rear seat backrest to release the locked state of the backrest, adjust the seat to the desired position, release the control lock lever. Ensure the backrest is completely locked in position.

Folding Rear Seats

To increase luggage space, fully lower (or remove) all head restraints, pull up the respective control lock levers and fold the seat backrest forward.

Note: *When the head restraint of the rear seat is not fully lowered or the backrest of the front seat is inclined backward excessively, the folding of the rear seat is very likely to damage the back of the front seat, small storage compartment or head restraint of the rear seat.*

Unfolding and Locking Rear Seat Backrests

To return the rear seat backrest to an upright position, pull the control lock lever to release the lock, raise the rear seat backrest, when the desired upright position is reached, a 'click' will be heard. Ensure the backrest is locked in position

Note: *When returning the rear seat backrest to the desired position, make sure that the rear seat belt is not trapped.*

SEATS & RESTRAINTS

Seat Belts



It is important that all seat belts are worn correctly. Always check that all passengers are wearing seat belts. DO NOT carry passengers that are unable to wear correctly positioned seat belts. Wearing seat belts incorrectly may cause serious injury or even death in the event of a collision.



Airbags can not replace seat belts. Airbags can only provide extra support when triggered, and not all traffic accidents will trigger airbags. Whether airbags are triggered or not, seat belts can reduce the risks of serious injury or death in accidents. Therefore, seat belts must be worn correctly.



Never unfasten a seat belt whilst driving, serious injury or death may occur in the case of an accident or emergency braking.



Never fasten the driver seat belt or use a buckle replacement when the driver seat is vacant or when exiting the vehicle. This could cause the engine to restart automatically.



This vehicle is equipped with seat belt warning lamp to remind you to fasten your seat belt.

During driving, seat belts must be fastened.

You can never predict if you will be involved in a collision accident and how serious it may be.

In many cases of collision accidents, passengers with seat belts correctly fastened are well-protected, while passengers with seat belts not fastened suffer from serious injury or even death.

Therefore, all passenger's must wear seat belts correctly, even during short-distance journeys.

Protection Provided by Seat Belts



It is of equal importance for passengers in the rear seat to fasten their seat belts correctly. Otherwise, passengers with seat belts not correctly fastened will be thrown forward in accidents, and will endanger themselves as well as the driver and other passengers.

When the vehicle is in motion, the travelling speed of the occupants is identical to that of the vehicle.

In the event of a 'head on collision' or emergency braking, the vehicle may stop, but the occupants will carry on travelling until they come into contact with a stationary object. This object may be the steering wheel, dashboard, windscreen or front seats.

A correctly fastened seat belt will eliminate this risk of injury.

When the seat belt is worn correctly, it will lock automatically in collision accidents or emergency braking to reduce your speed together with the vehicle, so as to

prevent the out-of-control movement which may cause serious injury to driver and passengers.



SEATS & RESTRAINTS

Wearing Seat Belts



Incorrectly worn seat belts could cause injury or death in the event of an accident.



Seat belts are designed for one person, DO NOT share seat belts.



DO NOT wrap a seat belt around when holding a baby or child in your arms.



Remove any heavy coats or clothing when wearing a seat belt, failure to do so can affect protection provided by the seat belt.



Seat belts should not be wrapped around hard or sharp objects such as pens, spectacles or keys.



Seat belts cannot function correctly when the seats are reclined excessively. Do not drive when the seats are excessively reclined.

The seat belts fitted to your vehicle are designed for use by normal sized adults. This part of the literature refers to adult use. For advice on seat belt use with children, please see 'Children and Seat Belts'.

All seat belts are 3 point lap-diagonal belts

In order to maintain effective protection, the passengers must sit in the correct orientation, feet placed on the floor in front of them, with an upright body (no excessive recline) and the seat belt correctly fastened.

Fastening Seat Belts

Please follow the instructions below to fasten the seat belts correctly.

- 1 Adjust the seat correctly.
- 2 Hold the metal tab, pull the seat belt out steadily over the shoulder and across your chest. Ensure there is no twist on the belt.

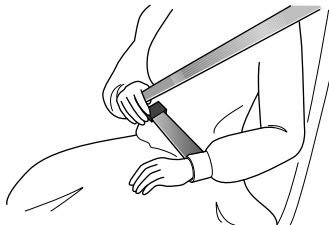

- 3 Insert the metal tab into the buckle until you hear a 'click', this indicates the seat belt is securely locked.

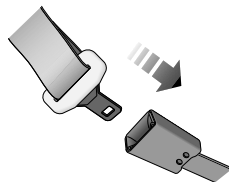

- 4 Remove any slackness in the belt by pulling up on the diagonal section of the belt.
- 5 To release the seat belt, press the red button on the buckle. The seat belt will retract automatically to its original place.

SEATS & RESTRAINTS

IMPORTANT

- Always ensure the seat belt will not become trapped in the door aperture when closing the door, damage will occur.
- Pulling the seat belt out too quickly may cause it to 'lock'. In this case, allow the seat belt to retract slightly and then pull it across your body slowly.
- If it is difficult to pull the seat belt out, it may be due to twisted webbing. If this is the case, fully extract the seat belt, remove the twist, allow the seat belt to retract slowly.
- After using the rear outer seat belts, please ensure the belt is installed in the D pillar retaining clip. This will prevent the belt becoming jammed when folding the rear seat.

Correct Routing of the Seat Belts



Ensure the seat belt is correctly positioned on the body, never cross the neck or abdomen, never pass the seat belt behind the back or under the arms.

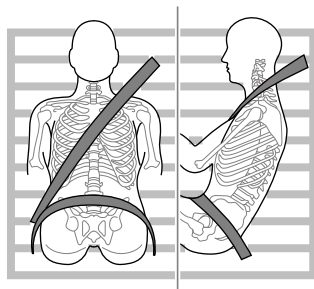

When wearing seat belts, the lap belt section should be positioned as low as possible across your hips, never across the abdomen. In the event of a collision, the lap belt can apply a force on the hips and reduce the possibility of you slipping under the lap belt. If you slip under the lap belt, the belt will apply force on your abdomen, which may cause serious or fatal injuries. The diagonal section of the belt should cross the middle of the shoulder and the chest. In the event of emergency braking or collision, the diagonal section of the belt will be locked.

To ensure that the seat belts always provide maximum protection, ensure the belt is flat, not loose and contacts the body.

Upper Anchorage Height Adjustment

! *During driving, DO Not adjust the height of seat belt.*

! *Ensure the fixing point of seat belt is adjusted to the proper height and locked before driving, otherwise injury or even death may occur in collision accidents.*

The vehicle is equipped with a seat belt fixing point adjuster on driver seat and front passenger seat. Adjust the height so that the diagonal section of the belt crosses the middle of the shoulder. The seat belt should be positioned away from the neck and head and in a manner where the occupant cannot slide under the belt. incorrect positioning will reduce the efficiency of the seat belt in the event of a collision or emergency braking.

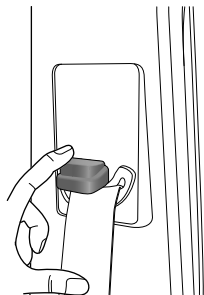

Adjusting the seat belt fixing point correctly.

- 1 Hold the seat belt.
- 2 Press release button and move the height adjuster to desired position. Move the adjuster by pushing the slider.
- 3 After moving the adjuster to desired position, release the button and try to move the adjuster downward to determine whether it is locked in place.

SEATS & RESTRAINTS

Seat Belts During Pregnancy

Wearing correctly positioned seat belts will provide protection for both mother and unborn child in the event of a collision or emergency braking.



The diagonal section of the seat belt should pass across the chest as normal, the lap section of the belt should pass below the belly, low and snug on the hip bones. NEVER position the belt on or above the belly.

Please consult your physician for further details.

Seat Belts and Disabilities

It is a legal requirement that all occupants wear seat belts, this include people with disabilities.

Depending upon the disability, consult your physician for further details.

Seat Belt Pre-tensioners



*The seat belt pre-tensioners will only be activated once and then **MUST BE REPLACED**. Failure to replace the pre-tensioners will reduce the efficiency of the vehicle's front restraint system.*



If the pre-tensioners have been activated, the seat belts will still function as restraints, and must be worn in the event that the vehicle remains in a drivable condition. The seat belt pre tensioners should be replaced at the earliest opportunity by an MG Authorised Repairer.

The vehicle is fitted with seat belt pre-tensioners, these are designed to retract the front seat belts and work in conjunction with the airbags in the event of a severe collision. They are designed to retract the seat belt and 'secure' the occupant in the seat.

The airbag warning light on the instrument pack will alert the driver to any malfunction of the seat belt pretensioners.(see 'Warning Lamps and Indicators' in the 'Instruments and Controls' chapter).

The seat belt pre-tensioners can only be activated once, after activation they must be replaced. This may also involve replacement of other SRS components. Please refer to 'Replacement of Airbag System Components After a Collision'.

IMPORTANT

- Seat belt pre-tensioners will not be activated by minor impacts.
- The removal or replacement of a pre-tensioner must be carried out by the manufacturer trained, dealer technicians.
- 10 years from the initial date of registration (or installation date of a replacement seat belt pre-tensioner), some components will need to be replaced. The appropriate page of the Warranty and Maintenance Manual must be signed and stamped once the work has been completed.

SEATS & RESTRAINTS

Seat Belt Checks, Maintenance and Replacement

Seat Belt Checks



Split, worn or frayed seat belts may not function correctly in the event of a collision, if there are any signs of damage, replace the belt immediately.



Always ensure the red release button on the seat belt buckle is pointing upwards to ensure easy release in the event of an emergency.

Please follow the instructions below to check the seat belt warning lamp, seat belt, metal tab, retractor and fixing device regularly;

- Insert the seat belt metal tab into the corresponding buckle and pull seat belt webbing close to the buckle quickly to check that the belt clasp locks.
- Hold the metal tab and pull the seat belt forward quickly to check that the seat belt reel locks automatically, preventing the webbing from extending.

- Fully extract the seat belt and visibly examine for twists, fraying, splits or worn areas.
- Fully extract the seat belt and allow to return slowly to ensure continual and complete smooth operation.
- Visibly examine the seat belt for missing or broken components.
- Ensure the seat belt warning system is fully functional.

If the seat belt fails any of the above tests or inspections contact an MG Authorised Repairer immediately for repairs.

Seat Belt Maintenance



Seat belt repairs should only be carried out by an MG Authorised Repairer.



Ensure no foreign or sharp objects become lodged in the seat belt mechanisms. Do not allow liquids to contaminate the seat belt buckle, this could affect the buckle engagement.

Seat belts should only be cleaned with warm soapy water. Do not use any solvent to clean the seat belt. Do not attempt to bleach or dye the seat belt, it may weaken the seat belt. After cleaning, wipe with a cloth and allow to dry. Do not allow the seat belt to fully retract before it is completely dry. Keep seat belts clean and dry.

If there are contaminants accumulated in the retractor, the retraction of the seat belt will be slow. Please use a clean and dry cloth to remove any contaminants.

Replacing Seat Belts



Collision accidents may damage the seat belt system. The seat belt system may not be able to protect users after damage which may result in serious injury or even death. After an accident, seat belts should be checked and replaced as needed immediately.

Seat belts should not require change after minor collisions, however, some other parts of the seat belt system may require attention. Please consult an MG Authorised Repairer for advice.

SEATS & RESTRAINTS

Airbag Supplementary Restraint System

Overview



The airbag SRS provides ADDITIONAL protection in a severe frontal impact only. It does not replace the need, or requirement to wear a seat belt.



The airbags together with the seat belts provide optimum protection for adults, but it is not the case for infants. The seat belt and airbag systems in the vehicle are not designed for protecting infants. The protection required by infants should be provided by child restraints.

The Airbag Supplementary System consists of:

- Front Airbags
- Seat Side Airbags
- Side Head Impact Protection Airbags
- Airbag Control Module

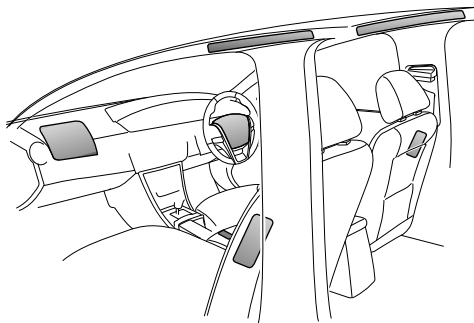

This vehicle is equipped with two front airbags for driver and front passenger, side airbags for front seats and side air curtains.

The frontal airbags are fitted in the centre part of steering wheel and the dashboard above the glovebox respectively. The frontal side airbags are fitted in the outer seatback cushion of the two front seats, side air curtains are fitted in the roof interior trim.

In the corresponding place where airbags are fitted, there is a warning sign stating 'AIRBAG'.

Airbag Warning Light



DO NOT service, repair, replace, modify or tamper with any part of the airbag, or wiring in the vicinity of an airbag component; this could cause the system to activate, resulting in personal injury.



A warning light, mounted on the instrument pack, will alert you to any malfunction of the airbags. The light will illuminate as a system check when the ignition is switched on and will extinguish after approximately 6 seconds.

If any of the following symptoms occur, the system should be inspected by your MG Authorised Repairer.

- The warning light fails to illuminate when the ignition is on.

- The warning light fails to extinguish within approximately 6 seconds after the ignition is switched on.
- The warning light illuminates while the car is being driven.

SEATS & RESTRAINTS

Airbag Deployment



Front seat passengers should not place feet, knees or any other part of the body in contact with, or in close proximity to a front airbag.



To minimise the risk of accidental injury from inflating airbags, seat belts should be worn correctly at all times. In addition, both driver and front seat passenger should adjust their seat to provide sufficient distance from the front airbags. If side airbags/side head impact protection airbags are fitted, both driver and front seat passenger should be seated to maintain sufficient distance from the upper part of the body to the sides of the vehicle, this will ensure maximum protection when the side airbags/side head impact protection airbags are deployed.



When airbags are deployed, children without proper protection may suffer from serious injury or even death. Do Not carry children in the arms or on the knees during traveling. Children should wear seat belts suitable to age. DO NOT lean out of windows.



An inflating airbag can cause facial abrasions and other injuries if the occupant is too close to the airbag at the time of its deployment.



DO NOT affix or place any objects on, or adjacent to the airbags. This may affect the airbag passage or create projectiles that may cause injury or serious harm in the event of airbag deployment.



After deployment the airbag components become very hot. DO NOT touch any airbag related components, it may cause burns or serious injury.



DO NOT knock or strike the position where airbags or related parts are located, so as to avoid accidental airbag deployment which may cause serious injury or even death.

In the event of a collision, the airbag control unit monitors the rate of deceleration or acceleration induced by the collision, to determine whether the airbags should be deployed. Airbag deployment is virtually instantaneous and occurs with considerable force, accompanied by a loud noise.

Provided the front seat occupants are correctly seated and with seat belts properly worn, the airbags will provide additional protection to the chest and facial areas in the event of the car receiving a severe frontal impact.

Side airbags and side head impact protection airbags are designed to offer additional protection to the side of the body facing the impact, if a severe side collision occurs.

IMPORTANT

- Airbags can not protect lower body parts of passengers.
- Airbags are not designed for rear collision, minor frontal or side impacts, or if the vehicle overturns; nor will it operate as a result of heavy braking.
- Deployment and retraction of the frontal and side airbags takes place very quickly and will not protect against the effects of secondary impacts that may occur.
- When an airbag inflates, a fine powder is released. This is not an indication of a malfunction, however, the powder may cause irritation to the skin and should be thoroughly flushed from the eyes and any cuts or abrasions of the skin.
- After inflation, front and side airbags deflate immediately. This provides a gradual cushioning effect for the occupant and also ensures that the driver's forward vision is not obscured.

SEATS & RESTRAINTS

Front Airbags



NEVER use a rearward facing child restraint on a seat protected by an ACTIVE AIRBAG in front of it, DEATH or SERIOUS INJURY to the CHILD can occur. Refer to 'Disabling Passenger Airbag'.



Front seat passengers should not place feet, knees or any other part of the body in contact with, or in close proximity to a front airbag.



In extreme cases driving on very uneven surfaces may cause airbag deployment. Please take extra care when driving on uneven roads.

Airbags are designed to deploy during serious impacts, the following conditions may cause airbag deployment.

- A frontal collision with unmovable or non deformable solid objects at a high speed.

- Conditions that can cause serious chassis damage, such as a collision with kerbstones, road edges, deep ravines or holes.

Seat Side Airbags



The manufacture and material of the seat is critical to the correct operation of side airbags. Therefore, please do not fit seat covers which may affect side airbag deployment.

In the event of a serious side impact, the relevant side airbag will deploy (only the affected side).

- The airbag will be deployed in the event that the side of the vehicle is impacted with a solid object or another vehicle.

Side Head Impact Protection Airbags

In the event of a serious side impact, the relevant side head airbag will deploy (only the affected side).

- The side head airbag will be deployed in the event that the side of the vehicle is impacted with a solid object or another vehicle.

Conditions in Which Airbags Will Not Deploy

The deployment of airbags does not depend on the vehicle speed, but on the object that the vehicle hits, angle of impact and the rate at which the car changes speed as a result of a collision. When the impact force of collision is absorbed or dispersed to vehicle body, airbags may not deploy; however, airbags may sometimes deploy according to impact condition. Therefore, the deployment of airbags shall not be judged based on the severity of vehicle damage.

Front Airbags

Under certain conditions the front airbags may not be deployed. Some examples are listed below:

- The impact point is not central to the front of the vehicle.
- The impact is not of sufficient force (the impact is with an object that is not solid, such as a lamp post or central barriers).
- The impact area is high (collision with the tailgate of a truck).
- Impacts to the rear or side of the vehicle.

- The vehicle rolling over.

Seat Side Airbags and Side Head Impact Protection Airbags

Under certain conditions the seat side and side head airbags may not be deployed. Some examples are listed below:

- Side impacts at certain angles.
- Light side impacts such as a motorcycle.
- Impacts that are not central to the side of the vehicle, either too far toward the engine compartment or the boot.
- The vehicle rolling over.
- The angled impact is not of sufficient force (the impact is with an object that is not solid, such as a lamp post or central barriers).
- The impact is not of sufficient force (with another vehicle, stationary or moving).
- The impact is from the rear of the vehicle.

SEATS & RESTRAINTS

Disabling the Passenger Airbag



The Passenger Airbag should only be disabled when a rear facing child seat is fitted to the front passenger seat.



When an adult is seated in the front passenger seat, ensure that the airbag is switched on.

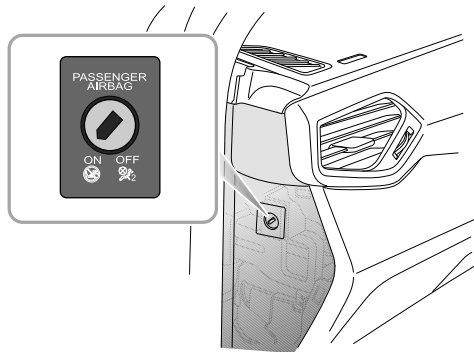

The passenger airbag disable switch is located on the left hand side of the dashboard in a side panel. To disable the passenger airbag, insert the key blade (or suitable substitute) and rotate to the 'OFF' position.

To enable the passenger airbag, rotate the switch in the opposite direction.

Service and Replacement of Airbags

Service Information



DO NOT install or modify the airbag. Any changes to the vehicle structure or airbag system wiring harness are strictly prohibited.



Changes to vehicle structure is prohibited. This may affect the normal operation of the SRS.



DO NOT allow these areas to be flooded with liquid and DO NOT use petrol, detergent, furniture cream or polishes.



If water contaminates or enters the SRS it may cause damage and affect deployment. In this case contact an MG Authorised Repairer immediately.

To prevent damage to the airbag SRS, the following areas should be cleaned sparingly with a damp cloth and upholstery cleaner ONLY:

- Steering wheel centre pad.

- Area of dashboard containing the passenger airbag.
- Area of roof lining and front pillar finishers which enclose the side head impact protection modules.

If the airbag warning lamp fails to illuminate, stays on, or if there is damage to the front or side of the vehicle, or the airbag covers show signs of damage, contact an MG Authorised repairer immediately.

IMPORTANT

- The removal or replacement of an airbag module should be carried out by an MG Authorised Repairer.
- After 10 years from the initial date of registration (or installation date of a replacement airbag), some components will need to be replaced by an MG Authorised Repairer. The appropriate page of the Warranty and Maintenance Manual must be signed and stamped once the work has been completed.

SEATS & RESTRAINTS

Replacing Airbag System Parts After a Collision



Even if the airbag does not deploy, collisions may cause damage to the airbag system in the vehicle. Airbags may not function properly after damage, and can not protect you and other passengers when a second collision occurs, which may cause serious injury or even death. To ensure that airbag system can function properly after collision, please go to an MG Authorised Repairer to check airbags and repair as necessary.

Airbags are designed for using once only. Once the airbag is deployed, you must replace the airbag system parts. Please go to an MG Authorised Repairer for replacement.

Disposal of Airbags

When your vehicle is sold, ensure that the new owner knows the vehicle is equipped with airbags, and is aware of the replacement date of the airbag system.

If the vehicle is scrapped, the undeployed airbags may have potential risks, therefore, before the disposal, they must be

deployed safely in a certain environment by a professional from an MG Authorised Repairer.

Child Restraints

Important Safety Instructions about Using Child Restraints

It is recommended that children below the age of 12 years old should be seated on the rear seat of the vehicle, in a child restraint system appropriate to the children's weight and size. Infants less than 2 years old should be restrained in an infant child restraint system.

It is recommended that a child restraint system that complies with UN ECE R44 standard are fitted in this vehicle. Check markings on the child restraint system.

There are a number of child restraint systems available of different type and specification. For optimum protection, it is recommended that you choose restraint systems appropriate to the child's age and weight.

It is important to comply with installation instructions supplied by the child restraint manufacturer and that child restraint system is properly secured to the vehicle. Failure to follow these instructions may cause death or serious injury to the child in an event of a sudden stop or accident.

- All occupants, including children must wear seat belts or use an appropriate child restraint.
- It is recommended that children under 12 years of age or less than 1.5 metres tall should use the appropriate child restraint fitted to the rear seat.
- Only one child can be carried in any one restraint.
- **DO NOT** put the child on the lap or in arms when sitting in any seat.
- Always adjust the rear seat back rest to a central position and ensure it is locked in position when installing a child seat or restraint.
- If installing a rear facing child restraint to the rear seat, the corresponding front seat should be adjusted forward; if installing a forward facing child restraint to the rear seat, you may need to adjust the height of the headrest.
- Never let your child stand or kneel on the seat during driving.
- Always ensure the child is seated correctly in the child restraint.
- The ways of using seat belts have a great influence on the maximum protection offered by the seat belt, you

SEATS & RESTRAINTS

must comply with the child restraint manufacturer's instructions on proper use of seat belts. If seat belts are not properly fastened, a minor traffic accident may also lead to injury.

- Child restraints that are not fitted correctly may move and injure other occupants in the event of an accident or emergency braking. Therefore, even if there is no infant or child in the child restraint, it also should be fitted properly and securely in the vehicle.

Warnings and Instructions on Use of Child Restraint on Front Passenger Seat



When the front passenger airbag is active, never install a rear facing child restraint on the front passenger seat, severe injury or even death can occur.



In cases where there is a need to install a rear facing child restraint on the front passenger seat, use the key to deactivate the front passenger airbag function, or severe injury or even death can occur.



Once the child restraint is removed from the front passenger seat, use the key to reactivate the front passenger airbag.



When installing a child restraint on the front passenger seat, move the front passenger seat as far rearwards as possible.



Use 1 child restraint per child.

Please study the safety warning label on the sun visor. Where possible always install child restraints on the rear seat. If it is necessary to install a child restraint on the front seat please observe the warnings above.

Children's Safety and Side Airbags



Children should not be allowed in areas where airbags may be deployed, there is a risk of serious injury.



Only recommended child restraints suitable for the age, height and weight of the child should be used.



Do not place any items in areas where airbags may be deployed, there is a risk of serious injury.

In the event of a side collision, the side airbags can provide better protection for the passenger. However, when the airbag is triggered a very strong expansion force is generated, if the passenger's seating position is not correct,

the airbags or items in the side airbag deployment area may cause injury.

When the correct child restraint is used to secure the child properly in the rear seat and the child's seating position is correct, there is enough space between the child and the side airbag deployment region for the airbag to deploy without any hindrance, and thus provide the best protection.

SEATS & RESTRAINTS

Child Restraints Groups

Secured Using 3 Point lap Diagonal Belts



Please DO NOT put the rear facing child restraint in the front passenger seat, this may cause serious injury or even death.

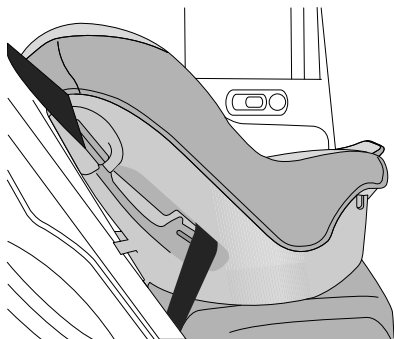

It is recommended that children should always be seated in the rear of the vehicle in a child restraint or restraint system, and fixed with 3 point, lap diagonal seat belts.

ISOFIX Child Restraint Systems



The ISOFIX anchorages in the rear seat are designed for use with ISOFIX systems only.



Child restraint anchorages are designed to withstand only those loads imposed by correctly fitted child restraints. Under no circumstances are they to be used for adult seat belts, harnesses, or for attaching other items or equipment to the vehicle.

Note: *When installing and using any child restraint system, always follow the manufacturer's instructions.*

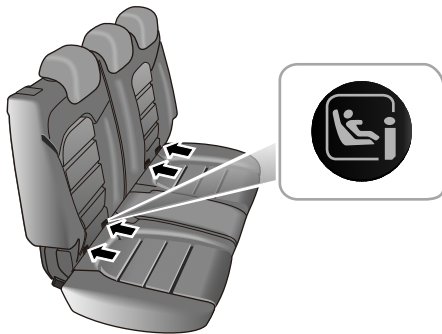

3

- Fasten vehicle-approved ISOFIX child restraint systems to the mounting brackets.
- When using ISOFIX mounting brackets for seat mounting, universally approved child restraint systems for ISOFIX may be used.

Note: *When using seat mounting, universally approved child restraint systems, Top-tether must be used.*

SEATS & RESTRAINTS

Note: Please refer to the child restraint system manufacturer's instructions for details.

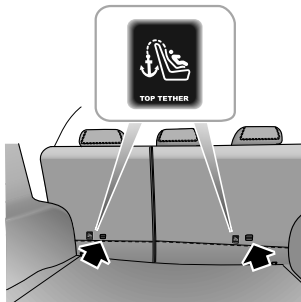

- Fasten the Top-tether of the child restraint system to the anchor at the rear of the rear passenger seat backrest.
- After installation apply suitable force to ensure the restraint is securely fastened.

Approved Child Restraint Positions

It is recommended that a child restraint system that complies with UN ECE-R44 standard are fitted in this vehicle. Check markings on the child restraint system.

Approved Child Restraint Positions (for non ISOFIX Child Restraints)

Mass Group	Seating Positions				
	Front Passenger			Rear Outboard	Rear Middle
	Without Front Passenger Airbag OFF Switch	With Front Passenger Airbag OFF Switch			
		Airbag ON	Airbag OFF		
0 group (less than 10 kg)	X	X	U	U	U
0+ group (less than 13 kg)	X	X	U	U	U
I group (9 ~ 18 kg)	X	X	U	U	U
II group (15 ~ 25 kg)	U	U	U	U	U
III group (22 ~ 36 kg)	U	U	U	U	U

Note: Description of letters in the table:

U = Suitable for universal child restraint systems approved for this mass group;

X = Seat position not suitable for child restraint systems in this mass group.

SEATS & RESTRAINTS

Approved Child Restraint Positions (for ISOFIX Child Restraints)

Seating Position		Mass group categories			
		0 group	0+ group	I group	
		Rear facing		Forward facing	Rear facing
		Up to 29 lbs(13 kg)		20–40 lbs(9 ~ 18 kg)	
Front Passenger Seat	Size Class	Not ISOFIX equipped			
	Seat Type				
Rear Outboard Seat ISOFIX	Size Class	C,D,E ¹	A,B, B1 ¹	C,D ¹	
	Seat Type	IL ²	IL ² ,IUF ³	IL ²	
Rear Center Seat	Size Class	Not ISOFIX equipped			
	Seat Type				

Note: IL Suitable for particular ISOFIX child restraints systems of the semi-universal category. Please consult child restraints systems suppliers' vehicle recommendation lists.

IUF Suitable for ISOFIX forward facing child restraints systems of universal category approved for use in this mass group

and ISOFIX size class.

¹ The ISOFIX size class for both universal and semi-universal child seat systems is defined by the capital letters grade A ~ G. These identification letters are displayed on the ISOFIX child seat.

² At time of publishing the recommended Group O+ ISOFIX baby safety seat is the Britax Romer Baby Safe. Consult an MG Authorised Repairer for the latest details relating to our recommended child seats.

³ At time of publishing the recommended Group I ISOFIX child seat is the Britax Romer Duo. Consult an MG Authorised Repairer for the latest details relating to our recommended child seats.

Table of I- Size child seats

The table gives a recommendation for which I- Size child seats suit which locations, and for what size of child.

The child seat must be approved in accordance with UN Reg R129.

Type of child seat	Front passenger seat	Rear outboard seats	Rear centre seat
I- Size child restraint systems	X	I-U	X

Note: I-U Suitable for use with forward and rear facing I- Size child restraint systems.

X Not suitable for use with I- Size restraint systems.

SEATS & RESTRAINTS

Group 0/0+ Child Restraint



When the front passenger airbag is active, never place a rear facing child restraint on the front passenger seat, severe injury or even death can occur.



Child restraints that can be adjusted to lying position are most suitable for infants who are lighter than 10 kg (normally for those younger than 9 months) or those who are lighter than 13 kg (normally for those younger than 24 months).

Group I Child Restraint



When the front passenger airbag is active, never place a rear facing child restraint on the front passenger seat, severe injury or even death can occur.

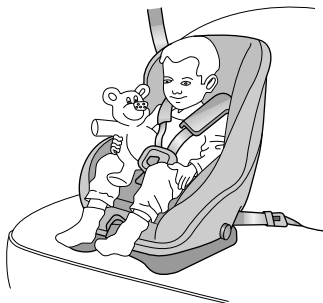

Backward/forward child restraints are most suitable for infants whose weight is 9 ~ 18 kg (normally for those older than 9 months and younger than 4 years old).

Group II Child Restraint



The diagonal section of the seat belt should pass across the shoulder and upper body, away from the neck. The lap section of the belt should pass across the hips,, away from the abdomen.



15 ~ 25 kg (normally for those older than 3 years old and younger than 7 years old).

The combination of child restraint and 3 point lap diagonal seat belt is most suitable for children whose weight is

SEATS & RESTRAINTS

Group III Child Restraint



The diagonal section of the seat belt should pass across the shoulder and upper body, away from the neck. The lap section of the belt should pass across the hips, away from the abdomen.

(normally for those about 7 years old or those older than 7 years old).



The combination of child booster seat and vehicle 3 point lap diagonal seat belt is most suitable for children whose weight is 22 ~ 36 kg and whose height is below 1.5 m

Starting & Driving

- 186 Keys
- 189 Child Proof Locks
- 190 Alarm Systems
- 196 Starting and Stopping Engine
- 201 Economical and Environmental Driving
- 205 Catalytic Converter
- 207 Fuel System
- 209 6-Speed Manual Transmission *
- 211 Twin-clutch Sportronic Transmission (TST) *
- 221 Brake System
- 231 Stability Control System (SCS) and Traction Control System (TCS)
- 233 Tyre Pressure Monitoring System (TPMS) *
- 235 Stop/Start —Intelligent Fuel Saving System
- 240 Cruise Control System
- 243 Active Speed Limit (ASL) System
- 246 Parking Aid *
- 250 Load Carrying

STARTING & DRIVING

Keys

Introduction



Please keep the spare key in a safe place - not in the car.



It is recommended that spare keys are not kept on the same key ring, since this may cause interference and prevent correct key recognition and therefore prevent the engine from starting.



The remote key contains delicate electronic components and must be protected from impact and water damage, high temperature and humidity, direct sunlight and the effects of solvents, waxes and abrasive cleaners.

Different key kits are provided according to the car configurations. One kit includes two mechanical keys; one kit includes a remote key and a mechanical key; and one kit includes two remote keys. Both of them can operate all locks.

The keys supplied with your car are programmed to your security system. Any key that is not programmed to your vehicle can not start the car.

The remote key will only work within a certain range. It's working range is sometimes influenced by the key battery condition, physical and geographical factors. For safety consideration, after you lock your car using the remote key, please recheck that the car is locked.

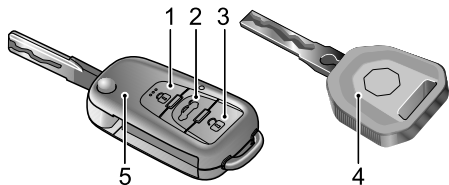

- | | |
|---------------------------|------------------|
| 1 Lock Button | 4 Mechanical Key |
| 2 Tailgate Release Button | 5 Remote Key |
| 3 Unlock Button | |

If your key is lost/stolen or broken, a replacement can be obtained from an MG Authorised Repairer. The lost/stolen key can be deactivated. If the lost key is found, an MG Authorised Repairer can reactivate it.

Note: Any key made independently outside of MG Authorised Repairer Network may not start the engine, and may affect the safety of your car. To obtain a suitable key replacement, it is recommended that you can consult MG Authorised Repairer.

Note: The new key cannot be offered to you immediately because it requires programming to the vehicle by the MG Authorised Repairer.

Note: Avoid operating the remote key close to strong radio interference devices (such as computer and other electronic products), or the normal function of the key may be affected.

Replacing the Battery *

Please replace remote key battery in the following conditions:

- The keys locking/unlocking function range is reduced.

- The engine immobilisation warning lamp on the instrument pack flashes, and the information centre display shows "Remote Key Low Battery, Please Replace".

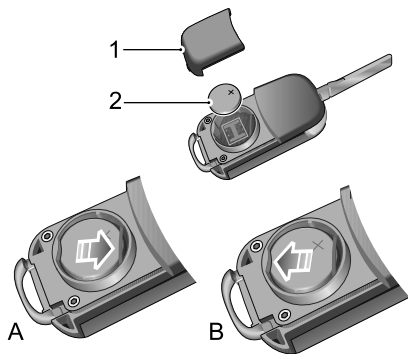

- 1 Unfold the remote key.
- 2 Carefully prise off the key cover (1).

STARTING & DRIVING

- 3 Press the battery slightly and push it forward (A) to remove the battery (2).
- 4 Position the new battery, ensuring that correct polarity is maintained (“+” side facing up), slide it backward (B).

Note: *Make sure that the polarity of battery is correct. (Positive is on the top)*

Note: *It is recommended that you fit a CR2032 replacement battery.*

- 5 Refit the cover and press tightly, check the gap around the cover is even.
- 6 Insert the remote key into ignition switch to resynchronise it.

IMPORTANT

- Use of an incorrect or inappropriate battery may damage the remote key. The new replacement's rated voltage, sizes and specifications must be the same as the old one.
- Incorrect fitting of the battery may damage the key.
- Disposal of the used battery must be strictly in accordance with relevant environmental protection acts.

Child Proof Locks



NEVER leave children unsupervised in the car.

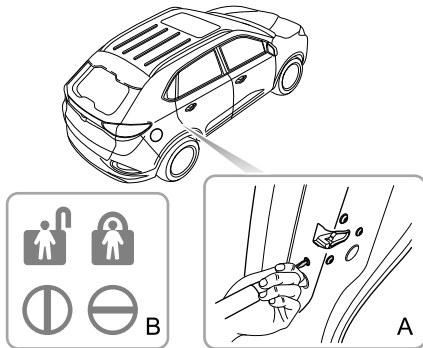

Lock or Unlock the Child proof Locks

- Open the relevant rear door, insert an appropriate flat-blade screwdriver into the child lock slot (A).

- Turn the slot to the required position (B).

Note: Turn clockwise for right rear door, and turn anti-clockwise for left rear door to enable. Turn back to the vertical position to disable.

With the child proof locks engaged, the rear doors cannot be opened from inside the car, but can be opened from outside the car.

STARTING & DRIVING

Alarm Systems

Your car is fitted with an electronic antitheft alarm and engine immobilisation system. To ensure maximum safety and operation convenience, we strongly recommend you to carefully read this chapter to fully understand the activation and deactivation of antitheft systems.

Engine Immobilisation

Engine immobilisation is designed to safeguard the vehicle from theft. Engine immobilisation can only be deactivated to start the engine by using the matched key.

Engine Immobiliser

When the matched key is inserted into the ignition switch and the car is started, engine immobilisation is deactivated automatically. When the key is removed from the ignition switch, the vehicle will automatically enable engine immobiliser. When the ignition switch is in position II, if engine immobiliser cannot identify the key inserted into the ignition switch, the engine immobiliser warning lamp on the instrument pack illuminates, and the information centre display of some models will show

Invalid Key. If the engine can still not be started by using the spare key, seek an MG Authorised Repairer.

Electronic Antitheft Alarm System

Locking and Unlocking

For specific configuration method of "Unlock Mode", please refer to "Vehicle Settings", "Air Conditioning and Audio Systems" section.

Operation of Remote Door Lock System

Key Locking

- Using the remote key to lock: press the lock button on the remote key to lock the car after closing the doors, engine bonnet and tailgate.
- Using the mechanical key to lock: insert the key into the driver's door lock and turn clockwise to lock all doors. If the key remains in the locked state for more than 2 seconds, all windows and sunroof will be closed automatically.

Key Unlocking

- Using the remote key to unlock: press the unlock button on the remote key once to unlock all doors. Single point entry is only available on some models.

- Using the mechanical key to unlock: insert the key into the driver's door lock and turn counterclockwise to unlock all doors. Single point entry is only available on some models. If the key remains in the unlock state for more than 2 seconds, all windows will be opened automatically.

Note: *If no panels are opened within 30 seconds after the vehicle is unlocked by using the remote key, all doors will automatically relock.*

Mislock

If the driver's door is not fully closed when the handset lock button is pressed, the vehicle horn will sound once, indicating a mislock. In this case, none of the doors will lock, the alarm system will not be armed and the direction indicator lights will not flash.

If the driver's door is closed, the passenger door, bonnet and tail gate are not fully closed, the horn sounds once to indicate mislock when the car undergoes locking operation. However, the 'partial arming' attributes of the security system will enable as much of the system to be armed as possible (all fully closed doors, bonnet or tailgate apertures

STARTING & DRIVING

will be protected, but an open door will not!). The alarm indicator will flash. As soon as the open aperture is closed, the system will automatically revert to an armed state.

Antitheft Alarm Indicator

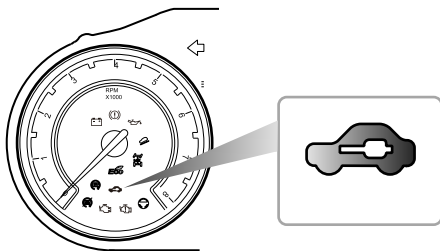

This light indicates the state of the antitheft alarm system.

- Operation of electronic antitheft alarm function:
Engine immobiliser warning lamp will flash as a warning until the alarm is deactivated.

- Partial operation of electronic antitheft alarm function (mislock):

If a mislock is caused by the driver's door, the engine immobiliser warning lamp does not flash, and the car does not enter the protected state. If mislock is caused by other doors, the engine immobiliser warning lamp will flash.

Antitheft Alarm Sound

If the antitheft alarm has been activated, before it is turned off, the car horn will sound for 10 times; each time will last for 30 seconds. Press the lock or unlock button on the remote key. The horn will stop sounding. Once the door is opened, the information centre display of some models will show "Alarm Triggered" and the antitheft alarm indicator light..

Interior Lock and Unlock Switch

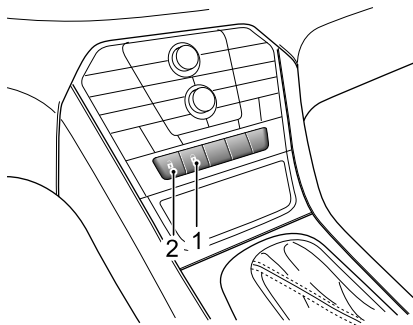

- 1 Lock Switch
- 2 Unlock Switch

When the antitheft alarm system is not in operation, press the lock switch (1) to lock all doors; press the unlock switch (2) to unlock all doors.

Note: If the antitheft alarm system is switched on, pressing the lock/unlock button will not lock/unlock the doors but will trigger the alarm system.

If the doors, bonnet and tailgate are closed, press the interior lock switch. The yellow indicator on the interior lock switch illuminates.

If a mislock is caused by non-driver door, tailgate or bonnet, press the interior lock switch. The yellow indicator on the interior lock switch illuminates. The information centre displays the view of the corresponding side door/tailgate or bonnet that is open.

STARTING & DRIVING

Interior Door Handles

Use the door handles to open the door:

- 1 First operation of the door handle unlocks the door.
- 2 Second operation of the door handle opens the door.

Speed Lock

All the doors will be locked automatically when the road speed exceeds 10 mph (15 km/h)

Automatic Unlock

When the ignition switch is switched off, all the doors will be unlocked automatically. For some models, "Automatic Unlock" can be switched on and off.

For specific configuration method of "Automatic Unlock", please refer to "Vehicle Settings", "Air Conditioning and Audio Systems" section.

Tailgate



If the tailgate can not be closed due to the type of cargo loaded, be sure to close all windows during driving, select the face distribution mode of the air condition, and set the blower to maximum speed, so as to decrease exhaust fumes entering the vehicle.

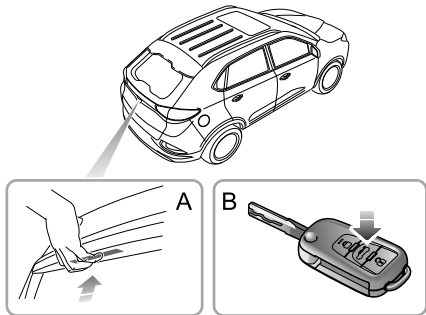

When the car is unlocked, press the open switch on the tailgate to open the tailgate (A).

Note: *For a vehicle equipped with remote key, press the release button (B) for more than 2 seconds to open the tailgate.*

STARTING & DRIVING

Starting and Stopping Engine

Ignition Switch



When the vehicle is in motion, do not switch off the ignition or remove the key, otherwise the steering wheel may be locked, making it impossible to turn the vehicle.



DO NOT remove or touch the key while the car is in motion.

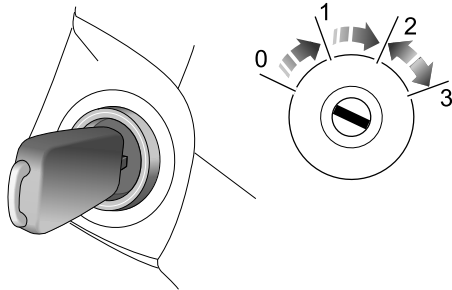

The ignition switch is located on the right side of the steering column. Function of each position is as follows:

Position 0 (LOCK/OFF)

- The key can be inserted or removed.
- After the engine is stopped and the key is removed, turn the steering wheel to one side to lock the steering wheel.

Position I (1) (ACC)

- The engine is not started and the key cannot be removed.
- Individual electrical equipment and accessories can now be operated, e.g. wipers, electric windows.

Position II (2) (ON/RUN)

- All instruments, warning lights and electrical circuits are operational.
- When the vehicle is started, the engine runs.

Position III (3) (START/CRANKING)

- Start engine. When the engine is starting, some electrical equipment will be isolated during cranking.
- Release the key immediately when engine starts, and the ignition switch will return to position II automatically.

Note: For auto transmission vehicle, the key can be turned from position I to position 0 only when the shift lever is in P (parking) position.

Note: When the ignition switch is in position I or II, if the driver side door is opened, an audible warning sounds to indicate that the key is not removed.

Note: When the steering wheel is locked and the key cannot be turned from position 0 to position I, please turn the steering wheel slightly whilst turning the key to unlock the steering wheel.

Starting the Engine



Never start or leave the engine running in an unventilated building - exhaust gases are poisonous and contain carbon monoxide, which can cause unconsciousness and may even be fatal.



Catalytic converters can be damaged if the wrong fuel is used, or if an engine misfire occurs. Before starting the engine, please read carefully the precautions detailed under the section "Catalytic Converter".

Starting the Engine:

- 1 Switch off all unnecessary electrical equipment (including the air conditioning) ;
- 2 Apply the parking brake (refer to "Brake System" of this chapter) ;
- 3 For auto transmission vehicle, make sure the shift lever is in P or N position.

STARTING & DRIVING

Note: *When the shift lever is in any other position, the engine cannot be started.*

- 4 For manual transmission vehicle, ensure neutral is selected and the clutch pedal is fully pressed;
- 5 Insert the key and turn the ignition switch clockwise to position III; then release the key immediately after the engine has started.

Note: *Continued use of the starter will not only discharge the battery, but may damage the starter and catalytic converter.*

Idle speed will decrease after engine warm-up. Do not increase engine speed immediately after starting the engine. Progressively operate the engine and transmission so that oil can warm-up and lubricate all operating components.

DO NOT press the accelerator pedal while starting and DO NOT operate the starter for more than 15 seconds at a time. If the engine fails to start, turn off the ignition switch and wait at least 10 seconds before trying again.

If the key is not recognised by the engine immobilisation system when it is inserted into the ignition switch, the

engine will be disabled. The relevant alarm icon and **Invalid Key** will appear on the information center (refer to "Information Centre" in "Instruments and Controls" chapter).

Cold Climates

In temperatures of -10°C and below, engine cranking times will increase. It is essential that all unnecessary electrical equipment is switched off while cranking.

IMPORTANT

- If you try to start consecutively for 3 times and it fails, please seek assistance from your local authorised MG dealer. When attempting to start the car consecutively please allow 10 minutes between attempts to allow battery restoration and engine cooling, failure to do this may result in battery or engine damage.
- Do not leave the ignition switch in position I or position II when the engine is not running, otherwise it may lead to battery discharge .
- The vehicle is fitted with engine immobilisation system. Any independently made key cannot start the engine.
- Your car is controlled by electronic control systems. When starting the engine, please make sure there are no electronic devices that can create electromagnetic interference near the vehicle. This may cause issues with the electronic control systems on the vehicle.

Stopping the Engine

Stopping the engine:

- 1 After bringing the car to a stop, ALWAYS apply the parking brake;
- 2 Apply parking brake;
- 3 For auto transmission vehicle, place the shift lever in P position;

Note: If the parking brake is applied but the shift lever is not fully in the parking (P) position, then there maybe be a risk of the vehicle suddenly moving and causing injury to yourself or others when starting the engine.

- 4 For manual transmission vehicle, place the shift lever in N position;
- 5 Turn the key from ON/RUN position to LOCK/OFF position to stop the engine, and remove the key.

Note: After strenuous towing or driving at high speed (particularly in hot weather), it is suggested to allow the engine to idle for a few minutes before

STARTING & DRIVING

switching off, which enables the cooling system to work continuously to lower the engine temperature.

Economical and Environmental Driving

Running-in

The engine, transmission, brakes and tyres need time to 'bed-in' and adjust to the demands of everyday motoring. During the first 900 miles (1,500 km), it is essential that you drive with consideration for the running-in process and heed the following advice:

- Do not allow the engine to exceed 3000 rpm in any gear or the vehicle speed to exceed 72 MPH (120 km/h).
- Do not operate at full throttle or allow the engine to labour in any gear.
- Do not drive at a constant speed (either high speed or low speed).
- Avoid heavy braking where possible.

After 900 miles (1,500 km), engine speeds can be gradually increased.

Environment Protection

Your car has been designed with the latest technology in order to minimise the environmental impact of exhaust emissions.

Driving Style

The way in which you drive your car has a significant bearing on environmental pollution, as well as affecting the amount of fuel you use.

Avoid full throttle acceleration

Steady, rather than rapid, acceleration uses considerably less fuel, reduces exhaust pollutants and also minimises the wear to mechanical components.

Avoid driving at maximum speed

Fuel consumption, exhaust emissions and noise levels all increase significantly at high speeds.

Do not drive in a low gear for longer than necessary

Driving in lower gears uses more fuel and creates more noise. Change up to a higher gear as soon as possible, provided it does NOT cause the engine to labour.

STARTING & DRIVING

Drive smoothly

Anticipating obstructions and slowing down well in advance, avoids the need for unnecessary acceleration and harsh braking. A smooth driving style not only reduces fuel consumption, but can reduce the emission of noxious gases.

Driving in rain



Emergency braking, accelerating and steering on slippery roads will reduce the vehicle's handling performance and grip.

When raining the windows may fog, reducing visibility (Use the Air-conditioning demist function).

Grip will be reduced, so please drive carefully.

Reduce speed when it rains.

Avoid aquaplaning (the effect of a film of water between the tyres and the road) affecting steering and braking performance.

Your MG is equipped with Brake Disc Wiping, activated by the wipers or rain sensor (where fitted). This will help

to keep the brake pads and discs clear of water and help restore brake performance.

Avoid driving through floods after heavy rain, which may lead to serious damage to the vehicle.

Fuel Saving and Extending Vehicle Life

The following are some suggestions on saving fuel and extending the life of the vehicles.

- Maintain the correct tyre pressure; insufficient air pressure will accelerate tyre wear and waste fuel.
- Do not carry unnecessary weight. Heavy loads will increase the engine load resulting in higher fuel consumption.
- Avoid engine idling for extended periods.
- Maintain slow and smooth acceleration and avoid harsh acceleration; change to a higher gear as soon as possible.
- Avoid labouring the engine or over running. Choose appropriate gears according to the road conditions.
- Avoid continuous acceleration or deceleration. A stop-go driving style will consume more fuel.

- Avoid unnecessary stopping and braking, maintain steady speed and attempt to anticipate traffic lights. Keep an appropriate distance from other vehicles to avoid emergency braking and reduce brake pad wear.
- Avoid traffic congestion and jam areas as much as possible.
- Do not ride the brake pedal, this can cause premature wear, overheating and increased fuel consumption.
- Maintain an appropriate speed on the highway. Higher speeds use more fuel. Appropriate speed can save fuel.
- Maintain the correct wheel alignment. Avoid collision with the kerb and reduce speed on uneven road surfaces. Out of specification wheel alignment will not only lead to excessive tyre wear, but also increases the engine load and fuel consumption.
- Avoid driving on mud or beaches. This will prevent corrosion of the vehicle underside.
- Maintain the vehicle in accordance with MG recommendations. Dirty air filters, oil etc., will reduce the engine's performance and raise fuel consumption. To extend the life of all components and reduce operating costs, regular MG Approved maintenance is needed.
- Do not stop the engine straight after high speed or long ascents or towing a trailer. Allow the engine to idle for 20 to 100 seconds depending upon driving loads and conditions. Avoid hard acceleration on a cold engine.

STARTING & DRIVING

Maintenance

Have the vehicle regularly serviced

Regular servicing will ensure optimum fuel consumption and minimise exhaust pollutants, as well as effectively extending the service life of the car.

Check tyre pressures regularly

Under-inflated tyres increase the rolling resistance of the car which, in turn, increases fuel consumption. Over or under-inflated tyres wear out more rapidly and also have a detrimental effect on the car's handling characteristics.

Do not carry unnecessary loads

The additional weight of unnecessary loads wastes fuel, especially in stop/start conditions where the car is frequently required to set off from stationary.

Catalytic Converter



Exhaust temperatures can be extremely high, do not park on ground where combustible materials such as dry grass or leaves could come into contact with the exhaust system - in dry weather a fire could result.

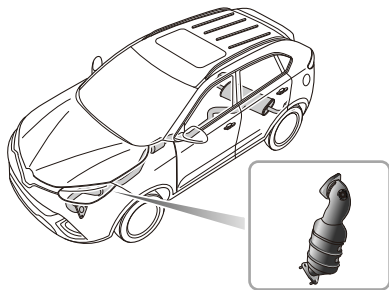

The exhaust system incorporates a catalytic converter, which converts poisonous exhaust emissions from the engine into environmentally less harmful gases. Catalytic converters are easily damaged through improper use, please observe the following precautions to minimise the chance of accidental damage.

Fuel

- Use **ONLY** fuel recommended for your car.
- Never allow the car to run out of fuel – this could cause serious damage to the catalyst system.

Starting

- Do not continue to operate the starter after a few failed attempts; seek MG Authorised Repairer.
- Do not operate the starter if an engine misfire is suspected and do not attempt to clear a misfire by pressing the accelerator pedal.
- Do not attempt to push or tow start the car.

Driving

Please pay attention to the following conditions:

- Do not overload or excessively 'rev' of engine.

STARTING & DRIVING

- Do not stop the engine when the car is in motion with a gear selected.
- Seek MG Authorised Repairer if you think your car's oil consumption is abnormal.
- If a misfire is suspected, or the car lacks power while driving, provided the engine has reached its normal operating temperature, it may be driven SLOWLY (at risk of catalyst damage) to an MG Authorised Repairer.
- Do not drive on terrain likely to subject the underside of the car to heavy impacts.

Note: Any engine misfire, loss of engine performance or engine run-on, could seriously damage the catalytic converter. Regular maintenance must be carried out in accordance with the schedule specified in the 'Warranty and Maintenance Manual'. Any modifications to engine without being authorised is prohibited.

Fuel System

Fuel Requirements



Use only the recommended fuel which meets national standard! Serious damage to the catalytic converter, a reduction in engine power/torque and increase in fuel consumption will occur if the wrong fuel is used.

Please use the fuel which is recommended and certified by the manufacturer. See 'Major Parameters of Engine' in 'Technical Data'.

If a lower grade of fuel is used, an engine knocking noise may occur, please use the recommended or above grade fuel as soon as possible. If the engine knocking noise is still noticeable after using the recommended or above grade fuel, please contact MG Authorised Repairer immediately.

Safety Precautions in a Fuel Filling Station



Vehicle fuel gases are highly flammable and, in confined spaces, are also extremely explosive.

Always take care when refueling:

- Switch off the engine.
- Do not smoke or use a naked flame.
- Do not use a mobile phone.
- Avoid spilling fuel.
- Do not overfill the tank.

STARTING & DRIVING

Fuel Filler

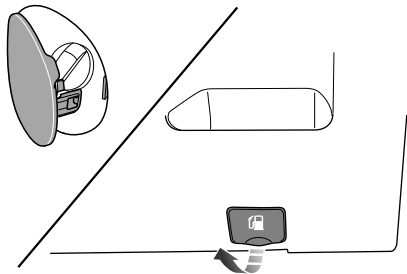

Fuel Filler Flap

The fuel filler flap is located on the rear left-hand wing. Pull the fuel filler flap release handle under the driver side instrument pack to open the flap.

Fuel Filler Cap

Unscrew the filler cap anti-clockwise and allow any pressure inside the tank to escape, before removing the cap.

After refueling, tighten the filler cap clockwise until you hear 3 "click" sounds.

Refueling

Do not fully fill the tank if the vehicle is to be parked in direct sunlight, or high ambient temperature - expansion of the fuel could cause spillage. The fuel filler tube is designed to accept a narrow, long filler nozzle. There is a cover at the filler neck, by inserting the filler nozzle thoroughly before fuel filling, the cover can be fully opened.

Start the engine after fuel filling. After refueling, if the engine runs unevenly, switch off and seek an MG Authorised Repairer before attempting to restart the engine.

6-Speed Manual Transmission *

Gear Shift Lever

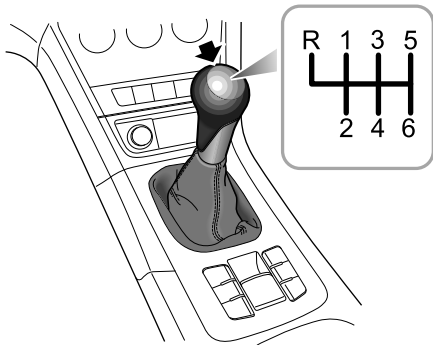

The manual transmission has 6 forward speeds plus a reverse gear (R). All gears have synchromesh.

Precautions while driving:

- 1 To select Reverse gear;

- a. Ensure the vehicle is stationary;
- b. Depress the clutch pedal (fully) ;
- c. Using the gear lever, from the Neutral position, push down on the lever, move it across to the left and then move it forward to the R position;
- d. Release the clutch as normal to engage Reverse.

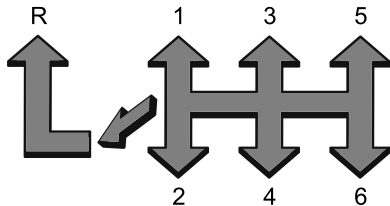

- 2 Do not rest your hand on the gear shift lever while driving - pressure from your hand may cause premature wear to the gear selector mechanism.
- 3 Do not rest your foot on the clutch pedal when driving - excessive wear to the clutch will result.

STARTING & DRIVING

- 4 Do not hold the car stationary on a hill by slipping the clutch. This will wear out the clutch.

Twin-clutch Sportronic Transmission (TST) *

Instructions

The following information is very important, please read carefully before use:

- Before starting the engine, place the gear lever in P or N position, ensure the foot brake is pressed and parking brake is applied.
- After the engine has started, ensure the foot brake and electronic parking brake are applied, shift the lever to the required gear.
- Release the electronic parking brake system and hold the foot brake until you are ready to manoeuvre the vehicle. Once the foot brake is released, on flat road, the vehicle will automatically start off at a slow speed without application of the accelerator.
- During driving DO NOT coast in neutral, it could damage the transmission or cause an accident.

Gear Shift

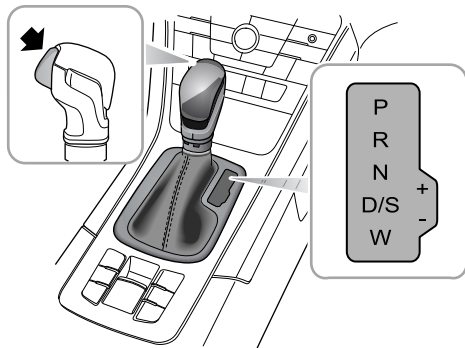

The twin-clutch sportronic transmission is a 7-speed automatic transmission.

Note: The highlighted letters or numbers in the information centre indicate the selected gear or mode.

STARTING & DRIVING

A lock button located in the gear lever, is used to prevent mistakingly selecting P (Park) or R (Reverse) whilst the gear selector is in other positions.

Shift Lever Operation



Unless necessary, it is not recommended to press lock button during gear shifting. This may allow inadvertent gear lever movement and incorrect gear selection causing possible damage.

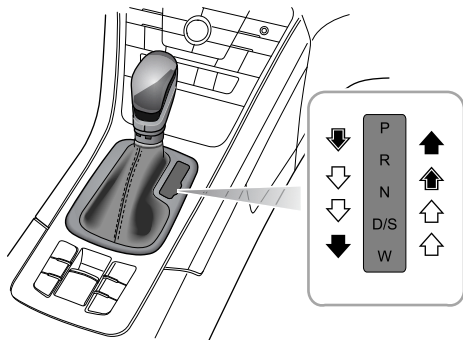

During the gear shift, operate the shift lever according to the instructions indicated by the following arrows:



Free gear shift.



Press and hold the lock button to shift the gear.



Press and hold the lock button and step on the brake pedal to shift gear.

Shift Lever Position



DO NOT move the gear shift lever into **P** or **R** from **D** whilst driving, this will cause severe transmission damage or cause an accident.

- P Park

When the shift lever is in this position, the transmission will be mechanically locked. Use this gear only when the vehicle is stationary and the electronic parking brake is applied.

Note: When the vehicle is parking on a hill, press the brake pedal and apply the electronic parking brake system first and then select **P**.

- R Reverse

Select this gear only when the vehicle is stationary and the engine is running at idle speed.

- N Neutral

Select this gear when the vehicle is stationary and the engine is running at idle speed for a long time (for example, waiting for traffic lights).

- D Drive.

This is used for normal driving and will allow automatic selection of 7 gears depending on vehicle speed and accelerator position.

- W Snow Mode

Select this mode when driving on soft or slippery road surfaces.

- S Sport Mode

Select this mode when a more sporty acceleration performance is required.

- + Upshift

Under Tiptronic mode, upshift the transmission to the next available high gear.

- - Downshift

Under Tiptronic mode, downshift the transmission to the next available low gear.

Removing Shift Lever from P in Emergency

If the gear lever cannot be removed from P despite the ignition switch being in position II and the brake pedal pressed, seek an MG Authorised Repairer.

STARTING & DRIVING

Gearshift Speed

Selecting D will allow the transmission controller to carry out gearshifts taking in consideration of a number of factors including engine speed, vehicle speed and accelerator position. Light accelerator pedal application will result in a gear-change at low speeds, larger pedal applications will result in gear-changes at higher speeds.

Kick-down



The drive wheels may skid when kick-down is activated on road surfaces with low adhesion, this may lead to the vehicle sliding out of control.

With D gear selected, pressing the accelerator pedal all the way down in one motion (also known as Kick-down) will provide better acceleration performance during overtaking. Under certain conditions, it will allow the transmission to shift to a lower gear immediately, and provide fast acceleration. Once the accelerator pedal is released, it will resume a suitable normal gear (based

on the vehicle speed and the position of the accelerator pedal).

Vehicle Start-off

The vehicle can only be started with the brake pedal pressed and P or N selected; after selecting the desired gear, and waiting for the full engagement of the transmission, release the brake pedal, the vehicle will automatically start off at a slow speed.

Driving on Hills



In cases where a short stop on a hill is required, such as a traffic jam, DO NOT momentarily apply the accelerator to prevent “roll back”. This could cause the transmission to overheat and result in damage.

Hill Start (Start Assist)

In cases of a hill start, where the vehicle has been stationary for some time, the foot brake has been released and the electronic parking brake applied, the starting aid function of the electronic parking brake (EPB) can be used to prevent the vehicle from rolling backwards. With the seat belt safely fastened, press the foot brake, apply the electronic parking brake system, and select the desired gear (D/R/W/S), then release the foot brake; press the accelerator pedal to engage vehicle drive, the electronic parking brake system will automatically be deactivated.

Models fitted with Hill Hold Control can use this function to assist hill starts. For details on hill hold control system, please refer to "Foot Brake" of "Brake System" section.

Note: The aid of these functions cannot defy the laws of physics. DO NOT drive the vehicle beyond its physical limitations, loss of control will still occur.

Downhill Driving



Repeatedly pressing the brake pedal may result in brake overheat, thereby causing the degradation of brake performance or even brake failure.

If driving down a hill for long distances, it is advised to move the gear shift lever to the right and select the Tiptronic mode. This allows manual gear selection. Use a lower gear selection to aid the slowing of the vehicle and thus avoiding over-use of the brakes. If a threshold is reached, the vehicle will automatically shift up, in these cases use of the brakes to slow the vehicle is necessary, at the same time re-select the lower gear.

STARTING & DRIVING

Control Mode

Economy Mode

Selecting D automatically places the vehicle in the Economy Mode. The information centre display will show "D". Economy Mode provides optimum fuel consumption and emissions.

Sport Mode

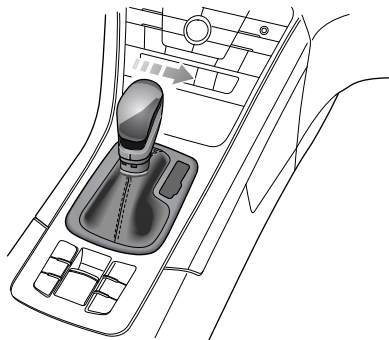

Once D is selected, move the shift lever to the right to enable the Sport Mode (the gear displayed in information centre changes to "S"). Under Sport Mode, the transmission upshifts later, so as to make full use of the power reserves of the engine.

Note: When "Sport Mode" is selected the instrument pack illumination turns red.

When better acceleration is required, please select the Sport Mode, but please note that the fuel consumption will be increased when driving in Sport Mode.

To exit Sport Mode, move the shift lever to the left back into D position.

Winter/Snow Mode

When driving on soft or slippery ground, place the shift lever to W position to enable Winter/Snow Mode (the gear displayed in information centre changes to "W"). The vehicle will shift to a higher gear at a lower speed than when D is selected, so as to reduce the tyre slip.

Cruise Control Mode

With the cruise control function enabled, the transmission will switch to the relevant gear for the vehicle speed automatically, thereby avoiding frequent gear shift when the system needs to maintain a constant speed.

Sport/Tiptronic Mode

With Sport/Tiptronic Mode selected, move the shift lever toward "+" or "-", this will enable Tiptronic mode. The gear displayed in the information centre will indicate the current gear with a single number (1 ~ 7).

On some models, it is possible to toggle the shift paddle on the steering wheel to enter Sport/Tiptronic mode.

Toggle the shift lever or paddle towards "+" direction to upshift to next available high gear; toggle towards "-" to downshift to next available low gear.

STARTING & DRIVING

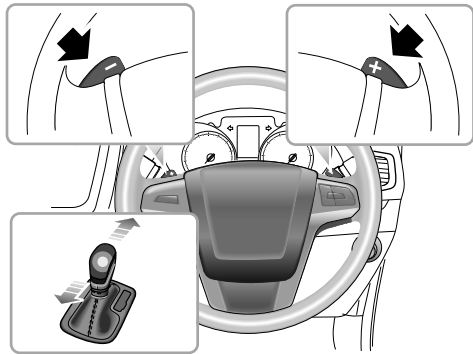

the engine speed exceeds a preset limit, the transmission will automatically shift up to the next gear to protect the engine.

To return to other gear modes, shift the lever across to the left and select D.

With Sport/Tiptronic Mode selected, if the driver makes an unreasonable gear selection, requests an upshift during low engine speeds, or requests a downshift during high engine speeds, the transmission will not respond and will remain in the current gear. If the vehicle is driven and the engine speed falls below a preset threshold in certain gears, the transmission will automatically shift down to the next gear to avoid engine stalling; when the vehicle accelerates, if

Protection Mode



When parking the vehicle, please ensure the vehicle is parked safely and that all traffic by-laws are observed.

Overheating Protection

Starting off frequently at high ambient temperatures may cause high transmission temperatures. In order to prevent damage, the system will perform an overheating protection routine, the message centre will display the relevant icon and messages accompanied by an audible alarm. Depending on the severity of the overheating, the warning messages may request the driver to "Increase Speed or Stop Safely", or "Stop Safely" (if circumstances allow).

With the transmission overheating, the warning message showing "Stop Safely" and the engine emission malfunction indicator lamp on, please park safely and shift the lever to P to allow the transmission to cool, the instrument pack information centre will display "Please Wait", during this time the engine can be switched off, vehicle exited and locked. Only when the transmission temperature has

decreased and the instrument pack information centre displays "Ready for Drive Away" can the vehicle start off.

If the driver adheres to the instructions displayed in the message centre for 20 minutes and the warnings have not altered or disappeared, seek an MG Authorised Repairer immediately.

Limp Mode

When some failures occur the transmission will enter Limp Mode and will only function in some gears, in some cases it may fail to reverse, during this time the information centre will display the engine emission malfunction indicator lamp. Seek an MG Authorised Repairer immediately.

Note: *In Limp Mode, the Tiptronic function is disabled.*

Severe Functional Malfunction

Some transmission malfunctions will cause the engine emission malfunction warning lamp to illuminate. To protect the transmission, the system may cut off engine

STARTING & DRIVING

power to the clutch and the vehicle cannot be driven.
Seek an MG Authorised Repairer immediately.

Brake System

Foot Brake

For added safety, the hydraulic braking system operates through dual circuits. If one circuit should fail, the other will continue to function, but greater pedal pressure will be needed, and increased brake pedal travel, and longer stopping distances will be experienced. In the event of a brake failure where only one circuit is operational, the car should be brought to a halt as soon as traffic conditions safely allow. DO NOT continue driving - seek an MG Authorised Repairer.

Servo Assistance

The braking system is servo assisted, always be aware of the followings during the operation:

- The servo assistance functions with the engine started up only. Never allow the car to freewheel with the engine turned off.
- Always take particular care when being towed with four wheels on the ground and the engine turned off. If the engine should stop for any reason while driving, bring

the car to a halt as quickly as traffic conditions safely allow, and do not pump the brake pedal as the braking system will lose any remaining servo assistance.

- Once the engine has stopped it will lose any remaining servo assistance, use suitable force to apply the brake pedal to stop the car safely in the current traffic conditions. Contact an MG Authorised Repairer.
- Efficiency of the brake servo booster can be affected by numerous conditions, such as engine speed loss. These conditions could result in extra force required to operate the brake pedal to stop the car.

Wet Conditions

Driving through water or heavy rain may adversely affect braking efficiency. The SCS (Stability Control System) includes a Brake Disc Wiping function which is activated when the windscreen wipers are used. However, always keep a safe distance from other vehicles and intermittently apply the brake pedal in conditions where the wipers are not used.

STARTING & DRIVING

Electronic Brake Force Distribution (EBD)

Your car is equipped with Electronic Brake Force Distribution, which, in order to maintain braking efficiency, distributes braking forces between front and rear wheels, under all load conditions.

EBD integrates a monitoring system. The monitoring system is linked to the brake system malfunction indicator lamp on the instrument pack. Refer to "Warning Lamps and Indicator Lamps" in "Instruments and Controls" section.

If the indicator lamp illuminates while driving, or remains illuminated after the ignition switch is turned on (ON position) and the parking brake is released, it indicates there is a failure with the braking system, and EBD may be inoperative. In such a case, stop the car as soon as safety permits and seek an MG Authorised Repairer immediately. DO NOT drive the car with the braking system malfunction indicator lamp illuminated.

Electronic Brake Assistance (EBA)

Your car is equipped with Electronic Brake Assist, which reacts to the speed at which the brake pedal is applied. If, in an emergency situation the brakes are applied faster than the limits set within the system, then full ABS application is applied to bring the car to a stop in the shortest possible distance.

Hill Hold Control (HHC)



HHC has limitations when subject to adverse conditions such as wet or icy surfaces and steep slopes.



HHC is not a substitute for parking brake application when carrying out a hill start. Do not exit the vehicle with only HHC applied, it may lead to a serious accident when HHC enable.



The car may roll if 'pull-away' is not achieved immediately after releasing the brake pedal.



Always ensure the brake pedal is pressed or EPB applied until drive is taken up by the clutch.



Firm application of the brake pedal when stopping is required by HHC to generate sufficient brake pressure to maintain hold.

Hill Hold Control is a comfort function. It works on inclines when the car detects it has come to a 'stand still status'. Once the clutch pedal has been pressed down and the brake pedal released, the vehicle will maintain pressure in the braking system for 1 – 2 seconds. After this, the Hill Hold will release.

HHC assists the driver by 'holding' the vehicle during hill starts.

The following conditions must be fulfilled to activate HHC:

- Stop the vehicle on a slope in excess of 3% and for more than 2 seconds.
- SCS is active and fault free.
- EPB is released and fault free.
- Clutch pedal is pressed (MT), or in D or R gear (TST).

- Ignition is ON.
- Sufficient brake pedal application force has been applied. If the driver releases the brake pedal on a hill, HHC will maintain brake pressure for 1 - 2 seconds, after this period the vehicle may roll.

Note: HHC cannot overcome physical limitations. DO NOT solely rely on HHC.

Note: HHC is available in both forward and backward directions when pulling away on uphill slopes.

STARTING & DRIVING

Auto Hold *



When auto hold stops the vehicle for reasons such as engine cut out, releasing the seat belt or pressing the auto hold switch, the electronic parking brake is applied. It cannot be guaranteed that the vehicle will be stabilised in all cases. For example, the rear wheels are on a slippery road surface, or the vehicle incline is too great (larger than 20%). Please make sure that the vehicle is safely stabilised prior to exiting.



DO NOT take any extra risks when driving due to the fact the vehicle is fitted with additional convenience functions. Always observe the surroundings and adjust your speed and driving styles to suit visibility, weather and traffic conditions.



The auto hold function cannot guarantee the stability of the vehicle when starting off or braking on hills especially on slippery or icy surfaces.



DO NOT leave the vehicle when the engine is operating and the auto hold is active.



Auto hold cannot guarantee the electronic parking brake operation in all cases where the engine is stopped. Please ensure the electronic parking brake is applied prior to exiting the vehicle.



The auto hold function should be switched off during the use of automatic car washes, the electronic parking brake may suddenly apply and cause vehicle damage.

If the vehicle is required to stop frequently for a length of time (such as traffic lights, traffic queues or stop/start), and the engine is running, the auto hold system assists in stabilising the vehicle, enabling you to remove your foot from the brake pedal when the vehicle is stationary and the Auto Hold active.

When the auto hold system is active, pressing the accelerator will release the brakes when pulling away.

Auto hold has 3 main states:

- 1 Off: Function in Off state
- 2 Standby: Function in Stand by state, it is then activated when the vehicle is brought to a stop and the brake pedal is released.
- 3 Parking: Function in Parked state. In this state the green (P) indicator in the instrument pack illuminates.

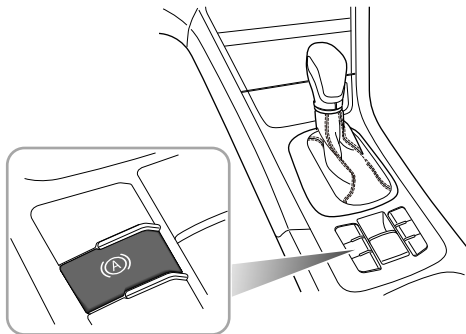

With the driver's seat belt fastened, the door closed and the engine running, press the auto hold switch to switch the auto hold function from Off to Standby state.

With the brake pedal firmly pressed and the vehicle completely stopped, the auto hold function will switch from the Standby state to the Parking state.

When the auto hold is in the Parking state, engaging D or R and pressing the accelerator will automatically release the auto hold function.

With the auto hold in the Parking state, it will result in the electronic parking brake being applied and the system exiting the Parking state in some cases (such as removing the seat belt, stalling or switching off the engine and stopping for a certain time etc.)

Note: With the brake pressed, press the switch to switch off the auto hold function, but the electronic parking brake will not be applied.

Note: It is recommended to turn off the auto hold function when reversing into the garage.

STARTING & DRIVING

Anti-lock Brake System (ABS)



ABS cannot overcome the physical limitations of stopping the car in too short a distance, cornering at too high a speed, or the danger of aquaplaning, i.e. where a layer of water prevents adequate contact between the tyres and the road surface.

The purpose of the anti-lock braking system (ABS) is to prevent the wheels from locking while braking, thereby enabling the driver to retain steering control of the car.

The fact that a car is fitted with ABS must never tempt the driver into taking risks that could affect his/her safety or that of other road users. In all cases, it remains the driver's responsibility to drive within normal safety margins, having due consideration for prevailing weather and traffic conditions.

Under normal braking conditions, ABS will not be activated. However, once the braking force exceeds the available adhesion between the tires and the road surface, thereby causing the wheels to lock, ABS will automatically

come into operation. This will be recognisable by a rapid pulsation felt through the brake pedal.

Braking in an Emergency



DO NOT pump the brake pedal at any time; this will interrupt the operation of ABS and may increase the braking distance.

If an emergency situation occurs, the driver should apply full braking effort even when the road surface is slippery. ABS will ensure that the wheels do not lock and that the car is brought to a halt in the shortest possible distance for the prevailing road surface conditions.

Note: On soft surfaces such as powdery snow, sand or gravel, the braking distance produced by the ABS system may be greater than that for a non-ABS system, even improved steering would be experienced. This is because the natural action of locked wheels on soft surfaces is to build up a wedge of material in front of (or to the side of, if steering) the tyre contact patch. This effect assists the car to stop when braking or to change direction when steering.

No matter how hard you brake, you are still able to continue steering the vehicle as normal.

IMPORTANT

ABS can not reliably make up for the driver's mis-operation or lack of experience.

ABS Malfunction Indicator Lamp

Refer to "Warning Lamps and Indicator Lamps" in "Instruments and Controls" section.

Note: *The normal (non-ABS) braking system remains fully operational and is not affected by partial or full loss of ABS. However, the braking distances may increase.*

Electronic Parking Brake (EPB)



In the event of EPB malfunction where EPB release is not possible, DO NOT tow the vehicle with all four, or rear wheels in contact with the road surface. Damage may occur.



In the event of a discharged battery, start the engine prior to attempting to release the EPB. Failure to do this may result in damage to the EPB system.



In the event of EPB malfunction where EPB release is not possible, please consult an MG Authorised Repairer in order to carry out an emergency manual release of the parking brake.

STARTING & DRIVING

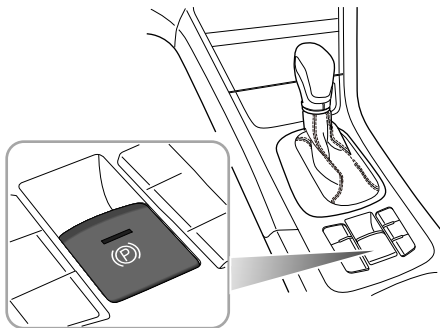

Applying the EPB

While the vehicle is stationary, the EPB can be applied. Ensure the EPB is applied every time the vehicle is left or parked.

- Pull the EPB switch upward until the indicator in the EPB switch illuminates.
- Simultaneously, the EPB indicator (P) will illuminate in the instrument pack. When the indicator in the EPB

switch and the EPB indicator are illuminated, it indicates that the EPB is applied.

- If the EPB failure warning lamp (R) in the instrument pack illuminates, it indicates that a fault has been detected. Please contact an MG Authorised Repairer immediately.

Note: An audible motor noise may be heard when applying or releasing the EPB.

Note: If the EPB is not used for a long period, the system may perform an automatic inspection operation that will emit an audible motor noise when applied.

IMPORTANT

- In the event of a flat battery or power failure it is not possible to apply or release the EPB. If using 'jump leads' to temporarily supply power please see 'Emergency Starting' in the Emergency Information.
- In the event of a power interruption or flat battery, the EPB will not operate and the warning lamp will illuminate. To restore normal operation, press brake pedal, press EPB switch and then pull EPB switch, (this may have to be repeated) the warning lamp will extinguish and normal operation will resume.

Releasing the EPB

- Place the ignition switch in position II, press the brake pedal, and press the EPB switch.
- If the indicator in the EPB switch and the indicator (P) in the instrument pack are extinguished, the EPB is released.

Start Assist

The EPB can predict the driver's intention and automatically release the EPB.

If the driver's seat belt is fastened, clutch pedal fully pressed, forward or reverse gear selected and the clutch pedal lifted whilst pressing the accelerator, the EPB will automatically release.

Emergency Braking Function



Inappropriate use of the electric park brake can lead to accidents and injuries. Do not apply the electric park brake for vehicle braking, unless in emergency.



During emergency braking using the EPB, DO NOT insert or remove the ignition key, this could result in serious injury.

In the event of normal brake failure, emergency braking using the EPB can be initiated by pulling and holding the EPB switch upward.

- If the SCS can respond actively to the request from the EPB, at speeds in excess of a predetermined limit the SCS will activate and apply all 4 brakes. At speeds below the predetermined limit the EPB will only activate the rear brakes. If the SCS is unable to respond to the

STARTING & DRIVING

request from the EPB, then the EPB will only activate the rear brakes.

- During emergency braking using EPB, a continual audible warning will sound. To cancel the emergency braking process, release the EPB switch or press the accelerator.

Stability Control System (SCS) and Traction Control System (TCS)

Stability Control System (SCS)

SCS is designed to assist the driver in control of driving direction. The SCS is automatically activated after the engine is started.

When SCS detects that the vehicle is not moving in the intended direction, it will intervene by applying brake force to selected wheels or through the engine management system to prevent sliding and assist in bringing the car back to the right direction.

Traction Control System (TCS)

The purpose of electronic traction control is to aid traction, thereby helping the driver to maintain control of the car in situations where one or both of the driving wheels are spinning (for example, if one wheel is on ice and the other on tarmac). The traction control system monitors the driving speed of each wheel individually. If spin is detected on one wheel, the system automatically brakes that wheel, transferring torque to the opposite,

non-spinning wheel. If both wheels are spinning, the system will reduce engine speed in order to regulate wheel rotation until traction is regained.

Switching On/Off

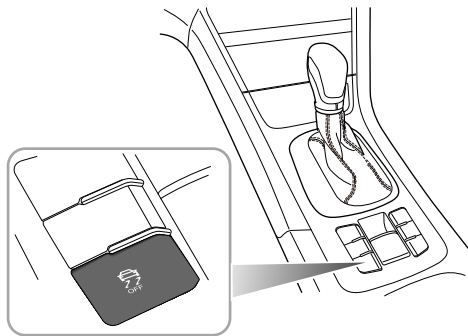

SCS and TCS are automatically switched to standby when the ignition switch is placed in ON position

STARTING & DRIVING

- Briefly press the SCS switch (less than 2 seconds). TCS is disabled, and the traction control indicator will illuminate. Traction Control System Off and the TCS icon will appear in the information centre.
- Press the SCS switch (more than 2 seconds). TCS and SCS are both disabled. The traction control System indicator will illuminate and Traction Control Off and the TCS icon will appear in the information centre, followed by the message Stability Control System Off and the SCS icons displayed.
- Briefly press the SCS switch (less than 2 seconds) again, SCS and TCS will resume, and warning lamps extinguish.

Note: *Disabling SCS and TCS will not affect the operation of ABS. Always disable TC when driving with snow chains fitted.*

Note: *Activation of the SCS/TCS switch in excess of 10 seconds will be regarded as a mis-operation.*

Stability Control/Traction Control Warning Lamps

Refer to "Warning Lamps and Indicator Lamps" in "Instruments and Controls" section.

Tyre Pressure Monitoring System (TPMS) *



TPMS can not replace routine maintenance and checks of the tyre condition and pressure.

Note: TPMS only warns of low tyre pressures, it does not re-inflate the tyre.

System Operation



The system is controlled by the SCS system, which constantly monitors the speed of each wheel. If, during normal driving conditions with the brakes not applied, the SCS detects that one wheel is rotating faster than the others, it deduces that the pressure of that tyre has fallen below the predefined limit of the system. As a result, the warning light on the instrument pack will illuminate (always yellow).

Check your tyres at the earliest opportunity and reinflate to the correct pressures. Refer to 'Tyre Pressures (Cold)'.

System Malfunction

This system is self-monitoring, if a malfunction is detected, the TPMS warning lamp (yellow) on the instrument pack will flash for 90 seconds first and then illuminate.

Note: When a puncture is detected, the system will require some time to analyse information prior to illuminating the warning lamp.

Under certain conditions the warning light may illuminate when a fault is not present. these conditions include:

- Driving on icy or wet surfaces.
- Front axle slip or excessive lateral acceleration.
- Snow chains fitted.
- A non recommended tyre fitted (including spare tyre).
- TPMS not reset after tyre replacement.
- TPMS not reset after tyre pressure adjustment.
- Rough terrain driving for excessive periods.
- Bending or mountain type terrain driving for excessive periods.
- Excessive luggage weight change from when last reset carried out.
- TPMS will not respond immediately if a tyre 'blows out'.

STARTING & DRIVING

Tyre Pressure Monitoring System Reset

If replacement tyres are fitted or tyre pressures changed, a TPMS reset is required - refer to TPMS reset in Instruments and Controls.

Note: *Inflate tyres to recommended pressures and check prior to reset.*

Note: *Always carry out a TPMS reset after tyre pressure adjustment. The TPMS carries out a self learning process after a reset and therefore may not react immediately after a reset.*

Stop/Start —Intelligent Fuel Saving System

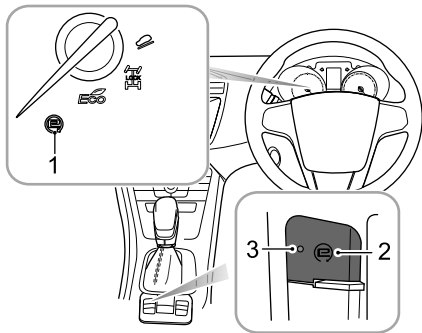

- 1 Instrument Pack Indicator
- 2 Main Switch
- 3 Switch Indicator Lamp

Engine Stop/Start has been incorporated into vehicles in an effort to reduce emissions. As the name suggests the system will allow the engine to be switched off when engine power is not required and then automatically be restarted when it is.

This system defaults “on” at ignition switch position II, the switch indication light is on (3 shown in fig) and can be turned off by pressing the main switch (2 in the fig). The lamp in the switch will extinguish.

Note: *If vehicle is driving through deep water, please use Stop/Start intelligent fuel saving system main switch (2 in diagram) to shut down Stop/Start intelligent fuel saving system.*

STARTING & DRIVING

Automatic Shutdown of Engine



Although the engine is not running after an automatic stop, the system is prepared to auto start therefore the following actions could be dangerous:

- 1 Leaving the vehicle while the seat belt is still buckled, or there is a substitute seat belt buckle inserted.*
- 2 Vehicles with automatic transmission: Leaving the vehicle while the gear selector is still in Drive position (R/D/S/I/W/Tiptronic).*
- 3 Carrying out work or checks in the engine compartment.*
- 4 Refuelling the vehicle, the ignition must be switched "OFF" or the key removed from the switch.*

Engine Auto Stop Conditions

Engine Auto Stop Conditions (Under Stop Start Control, warning lamp on, figure 1 in illustration)

- Vehicle is stationary, i.e. speed =0 mph or km/h.
- The vehicle speed prior to stopping exceeded 6 mph (10 km/h).
- Gearbox must be in neutral and clutch pedal is released (manual).
- Transmission in Drive with footbrake pressed (automatic)
- The driver's door is closed and seat belt is secured.
- The bonnet is closed.
- No demands on the steering (auto only).

Stop/Start Prohibited

Stop Start will not operate if:

- Coolant temperature is below a preset limit (4 segments on gauge).
- Front defrost is on.
- Battery power is below a preset limit.
- Cabin temperature versus ambient temperature difference is more than 5°C.
- A/C blower speed is set to speed 4 or above in manual mode.

- Temperature Hi - Hi is selected.
- Temperature Lo - Lo is selected.
- The vacuum in the braking system is below a preset limit.
- Starter motor temperature is above a preset limit.
- Reverse gear selected or has been selected prior to parking.
- Vehicle is standing at excessive angles (auto only).

Automatic Engine Start

With the engine stopped in the automatic stop/start condition, the following driver actions will cause an automatic restart, at this time the instrument pack indicator lamp is off.

- Models with manual transmission and in Neutral position: press the clutch pedal or accelerator pedal.
- Models with automatic transmission and in D position: release the brake pedal, or shift out of Drive position.

With the engine stopped in the automatic stop/start condition, the following actions will cause an automatic restart.

- Defrost is selected.

- Battery power falls below a preset limit.
- Cabin temperature falls causing ambient temperature difference to be more than 5°C.
- Manual A/C blower speed increased to speed 4 or above.
- Temperature Hi - Hi is selected.
- Temperature Lo - Lo is selected.
- The vacuum in the braking system falls below a preset limit.
- The vehicle begins to move.
- The Stop/Start master switch is pressed

At this time the Stop/Start fuel saving system indicator on the instrument will extinguish to indicate engine start phase. (1 in figure):

Start Inhibition

Note: *When a vehicle fitted with a manual transmission is under automatic Stop/Start control and the engine is required to restart, but neutral is not selected, the engine will restart when neutral is selected.*

STARTING & DRIVING

If any of the following conditions occur during automatic engine stop, the engine can only be restarted using the key, during this time the instrument pack indicator will extinguish.

- The driver side seat belt is unbuckled.
- The driver side door is open.
- Bonnet is open.

At this time the Stop/Start fuel saving system indicator on the instrument will extinguish to indicate engine start phase.(I in figure):

Stall Assist

Once Stop/Start intelligent fuel saving system is enabled without inhibition conditions.

On manual vehicles, if the engine cuts out, or is stalled whilst Stop/Start is enabled, selection of neutral and pressing the clutch pedal will automatically restart the engine.

Note: *Extremely low battery power may result in the engine not re-starting automatically, or even using the handset key. In this instance, external power is*

needed to start the engine or the battery will require re-charging. See the section 'Emergency Starting' in the 'Emergency Information' Chapter.

Battery



When charging the battery, starting the car with an external power source or supplying power from the vehicle, the negative cable must be connected to a suitable position on the vehicle body. Failure to do this will result in inaccurate battery power calculation which will effect automatic Stop/Start control.



DO NOT disconnect the battery sensor unless absolutely necessary. removal will result in inaccurate battery power calculation which will effect automatic Stop/Start control.

Note: *Failure to operate within the following guidelines will effect battery performance and automatic Stop/Start control:*

- 1 After power interruptions (battery disconnection) the automatic Stop/Start function will be suspended until the vehicle is left in a locked state for at least 4 hours whilst the system relearns the state of the battery.**
- 2 If the vehicle is run continually for more than 100 hours uninterrupted, the Stop/Start function will be suspended until the vehicle is left in a locked state for at least 4 hours whilst the system relearns the state of the battery.**
- 3 If the battery requires replacement, ALWAYS use a genuine part to the manufacturers specification.**

Failure to adhere to this can affect the automatic Stop/Start system.

Stop/Start Intelligent Fuel Saving System Failure

In the event of a Stop/Start Intelligent Fuel Saving System failure, contact an MG Authorised Repairer.

The Stop/Start Intelligent Fuel Saving System can be effected by faults within other vehicle systems - in the event of failure contact an Authorised MG Repairer.

Starter Inoperative, Serious Battery Capacity Loss

In the case of serious battery power loss, automatic Stop/Start and key start may not be possible. In this case refer to the Emergency Information chapter, Emergency Starting section for further details.

STARTING & DRIVING

Cruise Control System

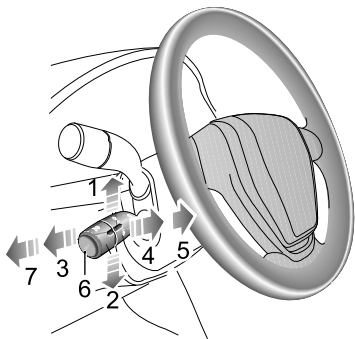

- Acceleration (1)
- Deceleration (2)
- Cruise Cancel (3)
- Cruise Standby (4)
- Cruise Resume (5)
- Cruise Set (6)
- ASL In Standby (7)

Cruise control enables the driver to maintain a constant road speed without using the accelerator pedal. This

is particularly useful for motorway cruising, or for any journey where a constant speed can be maintained for a lengthy period.

Cruise Control System Activation

Cruise control system is operated with a lever located, at the left side of the steering wheel underneath the lighting stalk switch.

With the ignition switch in position II, if the lever switch is in the 'ASL Standby' position (7 in figure), then the cruise control is OFF. To set the cruise control to 'Standby' pull the lever switch to 'Cruise Standby' (4 in figure), the green indicator lamp in the instrument pack will illuminate indicating the system is in 'Cruise Standby' mode.

With the system in 'Standby' when the current vehicle speed is above 25mph (40km/h), (the operating range is 25 - 125mph (40 - 200 km/h) press the 'Set' button (6 in figure). The indicator in the instrument pack will change to yellow and the cruise control will enter and activated state.

The target speed of the cruise system will be set at the current speed, and the cruise system will take effect. At

this time, the cruise control system will maintain the set speed without pressing the accelerator pedal.

Note: *The set speed held in the cruise control memory will be canceled when either the cruise control lever is switched to "ASL In Standby" position (figure 7) or the ignition switch turned off.*

Target Cruise Speed Adjustment

When the cruise control is active, the 'target speed' can be increased or decreased:

Push the lever switch upwards (1 in figure), this will increase the speed.

Push the lever switch downwards (2 in figure), this will decrease the speed.

Release the lever switch when the desired speed is reached.

Push the lever switch upwards or downwards briefly to increase/decrease the vehicle target speed in increments of 1mph/1km/h, then the vehicle will accelerate/decelerate to the new target speed.

Pressing the accelerator at any time will override the cruise control and allow acceleration to undertake manoeuvres such as overtaking. Releasing the accelerator will return the vehicle to the set target speed.

Pause/Stand By

Cruise control will be disengaged and set to 'Standby' if:

- Lever switch moved to 'Cruise Cancel' position (3 in figure).
- Brake pedal pressed.
- Auto gear lever moved to P, R or N.
- Manual gear-change made.
- Clutch pedal pressed.
- Conditions initiate SCS intervention.
- An incline causes excessive decline in speed.
- The EPB button is operated.

Resume

If the cruise control remains on after the disengagement, moving the lever switch to 'Cruise Resume' (5 in figure) will reinstate the target speed to the setting prior to disengagement.

STARTING & DRIVING

Note:

- *Never use the cruise control system in the reverse gear.*
- *Do not use the cruise control in unsuitable conditions, such as on slippery surfaces, excessively heavy rain or in traffic conditions that do not suit maintenance of constant speeds.*
- *When not in use, ensure the lever switch is in the 'ASL Standby' position (7 in figure).*
- *When the automatic transmission is in "Sport" mode, it is not recommended to use the cruise control system.*
- *During the operation of cruise control system, the actual speed may deviate from the target cruise speed to some extent due to road conditions (such as uphill, downhill, etc).*
- *If the actual speed is excessively lower than the target speed or SCS is activated due to the hill or road surfaces, the cruise control system may automatically revert to standby mode.*
- *Do not operate the switch for excessively long periods, or press multiple switches simultaneously,*

this may cause the system to fail. If this situation occurs, when it is safe to do so, cycle the ignition.

Active Speed Limit (ASL) System

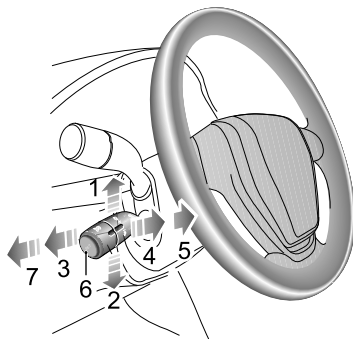

- | | |
|-------------------------|-------------------|
| 1. Speed Limit Increase | 6. Set (Activate) |
| 2. Speed Limit Decrease | 7. ASL In Standby |
| 3. Cruise Cancel | |
| 4. Cruise In Standby | |
| 5. Cruise Resume | |

The Active Speed Limit (ASL) system is designed to control the vehicle speed keeping it below a speed set by the driver.

The ASL system shares the same lever switch as the cruise control system, located to the left of the steering wheel below the indicator stalk. The switch can be toggled between both functions, however only one function can operate at any one time.

Activate

The desired target speed of the ASL system is displayed in the instrument information cluster, refer to "Information Centre" in the "Instruments and Controls" section. With the ignition switch in position II and the lever switch in "ASL Standby" (7 in figure), the ASL function is in standby mode by default, briefly moving the lever switch up/down (1,2) adjusts the target speed of the ASL. The range of target speed adjustment is 20 - 80mph or 30 - 130 km/h.

The target speed limit value will be increased or decreased by 5 mph or 5 km/h every time the lever switch is briefly moved upwards or downwards.

STARTING & DRIVING

Pressing the "Set" button (6 in figure) will activate the ASL system and set the speed limit. The ASL indicator lamp in the instrument pack will illuminate.

When activated if the vehicle speed is greater than the user inputted target speed the system will immediately begin to slow the vehicle to the inputted target.

Kick Down

With the system active if it is necessary to accelerate the vehicle e.g. overtaking maneuver, the system can be overridden by pressing the accelerator pedal passed a Kick down position. The kick down position is approximately 80% of the overall accelerator pedal travel. Once the kick down position has been reached the ASL system enters a standby state and returns the vehicle operation to the user, accelerating according to the demand from the accelerator pedal.

After a kick down event, once the vehicle speed has dropped below the target speed originally controlled to, the ASL system will automatically resume and control the vehicle to the target speed retained within the system.

Suspending ASL

When ASL is active to, suspend the feature press the "Set" button (6) and the ASL system will exit to the standby state returning control to the accelerator pedal.

Note: When suspended via the "Set" button (6) the previously inputted target speed will be retained within the system memory in the case that the system is reactivated.

Resuming ASL

If the system has been placed in a standby state with a retained target speed the system can be reactivated to the previously stored target speed by pressing the "Set" button.

Note: After the ignition is switched OFF, the target speed previously stored will be erased. In the interest of economy and safety, it is recommended to select different target speeds according to different driving and road conditions.

Overshoot of Target Speed and Warning

The system is designed to control the vehicle speed to within +/- 1.5 mph (2 km/h) of the inputted target speed.

However, the feature does not incorporate vehicle braking assist, therefore if the ASL system is attempting to control vehicle speed on a steep downhill incline the inertia of the vehicle may force the vehicle speed over the intended target speed.

If at any time the vehicle speed increases 2 mph (3 km/h) more than the desired target speed the system informs the user with continuous visual and periodic audible warnings. Once the desired target speed has been maintained the warnings are removed.

Note: *If the target speed has been deliberately exceeded i.e. Kick Down, only a visual warning is displayed.*

If the vehicle derivative is fitted with a Dual Clutch Transmission (DCT), gear "downshift" functionality will exist to support the control of vehicle speed in the case of overshooting of target speed.

DO NOT attempt to switch between miles and km after the ASL speed has been set.

STARTING & DRIVING

Parking Aid *

Ultrasonic Sensor Parking Aid



The purpose of the parking aid is to assist the driver during reversing! The sensors may not be able to detect certain types of obstruction, e.g. narrow posts or small objects no more than a few inches wide, small objects close to the ground, objects above the tail gate and some objects with nonreflective surfaces.



Keep the sensors free from dirt, ice and snow. If deposits build up on the surface of the sensors, their performance may be impaired. When washing the car, avoid aiming high pressure water jets directly at the sensors from close range.

Rear Parking Aid

Four ultrasonic sensors, situated in the rear bumper, scan the area behind the car searching for obstructions. If an obstruction is detected, the system calculates its distance from the rear of the car and communicates this information to the driver by sound warning chimes.

Parking Aid Operation

When the ignition switch is in position II, the rear parking aid is enabled automatically when reverse gear is selected, it is switched off as soon as reverse gear is disengaged. A short beep is given by the parking aid within 1 second after selecting reverse gear to indicate that the system is operating normally.

Note: *If a longer, higher pitched sound is emitted for 3 seconds when reverse gear is selected this indicates a fault in the system. In this case seek assistance from your MG Authorised Repairer.*

Warning Period of Parking Aid

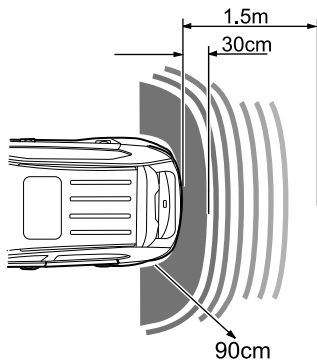

While reversing:

- If an obstruction is located within 1.5m range of the rear parking aid sensors or within 90cm range of the corner sensor, the warning commences. As the car moves closer to the obstruction, the audible sounds are transmitted more rapidly.
- Once the obstruction is within 30cm range of the rear bumper, the audible sounds will merge into a continuous warning.

STARTING & DRIVING

Parking Camera



The purpose of the parking camera system is to assist the driver during reversing! The camera has limited field of view and cannot detect obstructions outside the field of view.

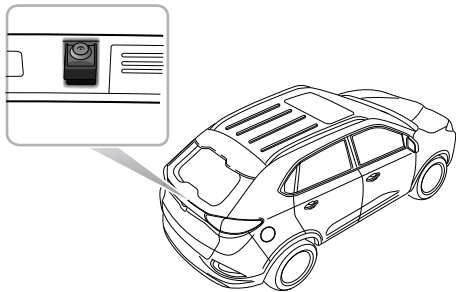

Some models have a rear parking camera fitted between the rear licence plate lamps. When reverse gear is selected, the camera will display an image of what is immediately behind the car. This image will be shown on the entertainment system screen.

Parking Aid Information



It is important to remember that the system is no more than an AID to parking. It is not foolproof in operation, nor is it a substitute for observation or personal judgement.

The entertainment system will provide parking aid display information and assist the driver to control the situation around the vehicle during parking.

With the entertainment system ON, selecting reverse will display the parking information on the entertainment system display screen (screens are model specific).

The colour of the parking aid display information is defined as follows:

- Grey: no obstruction is detected.
- Green: the distance to the obstruction is greater than 1m.
- Yellow: the distance to the obstruction is greater than 30cm and smaller than or equal to 1m.
- Red: the distance to the obstruction is smaller than or equal to 30cm.

The display as follows:

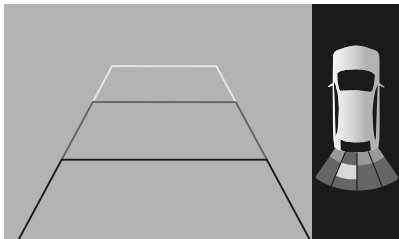

STARTING & DRIVING

Load Carrying



DO NOT exceed the *gross vehicle weight* or the *permitted front and rear axle loads*. Failure may result in *vehicle damage* or *serious injury*.

Load Space



Ensure that the *rear seat backrests* are *securely latched in the upright position* when *loads* are carried in the *load space behind the seats*.



If the *tailgate* can not be closed due to the *type of cargo loaded*, be sure to close *all windows* during driving, select the *face distribution mode* of the *air condition*, and set the *blower* to *maximum speed*, so as to decrease *exhaust fumes entering the vehicle*.

When luggage is carried in the load space, always ensure heavy items are placed as low and as far forward as possible,

so as to avoid the cargo shift in the event of an accident or sudden stop.

Drive carefully and avoid emergency braking or maneuvers.

Driving with the tailgate open is very dangerous. If the load being carried requires the tailgate to be open, please ensure the cargo is suitably secured and every measure is taken to prevent exhaust fumes entering the vehicle.

IMPORTANT

Traffic regulations must be observed when loading cargo, if the cargo extrudes the loadspace appropriate warning measures must be taken to warn other road users.

Internal Loading



DO NOT carry unsecured equipment, tools or luggage that could move, causing personal injury in the event of an accident , emergency braking or hard acceleration.



DO NOT obstruct the driver's or passenger's vision with loads.

Folding the rear seats can increase luggage space, refer to 'Rear Seat' described in the 'Seats and Restraints' chapter.

When cargo is loaded in the vehicle, place it at a position as low as possible and ensure that it is tightly secured, so as to avoid personal injury caused by cargo movement.

General Towing Safety

Your vehicle can tow a trailer if you carefully observe load limits, use approved equipment, and follow the towing guidelines. Always check load limits before towing.

Towing loads in excess of the maximum towing weight can seriously affect vehicle handling and performance, and could damage your vehicles engine and drive-train.

Note: *Exceeding any load limits advised by MG Motor UK Ltd is dangerous. Consult the recommended load limits and loading prior to any journey.*

Check the loading of your vehicle and trailer carefully before starting to drive.

Trailer hitch load should never exceed the limit advised by MG Motor UK Ltd.

Note: *Excessive towing loads reduce front tyre traction and steering control, too little trailer nose load can make the trailer unstable and cause it to sway.*

Tow bars: Only genuine MG approved tow bars should be fitted to your vehicle. Only use the attachment method specified by the vehicle manufacturer for securing the

STARTING & DRIVING

towing hitch. Contact your authorised MG dealer for more information.

Safety chains: Safety chains must be used as a precautionary measure should the trailer become unintentionally unhitched. Make sure the safety chain is securely attached to both the trailer and the vehicle prior to departure.

Altitude: Your engine delivers less power at higher altitude. If you tow a trailer in a mountainous area you should reduce the combined vehicle and trailer weight by 10% for every 1000m of elevation.

Gradients: Where possible, when towing, you should plan your journey to avoid steep gradients. The advised brake towing mass stated assumes a maximum gradient capability of 12% where possible it is recommended you drive on gradients less than 12%. Follow the trailer associations recommendations for suitable roads.

Running in period: Avoid towing a trailer during your vehicles first 1000 km or 625 miles.

Stop/Start function: Turn off Stop/Start function when towing just use. The trailer weight can affect your

vehicles braking efficiency if Stop/Start is activated on a hill while towing a trailer.

Emergency Information

254 Hazard Warning Devices

255 Emergency Starting

257 Vehicle Recovery

*261 Tyre Repair and Wheel
Replacement*

270 Fuse Replacement

279 Bulb Replacement

EMERGENCY INFORMATION

Hazard Warning Devices

Hazard Warning Lights

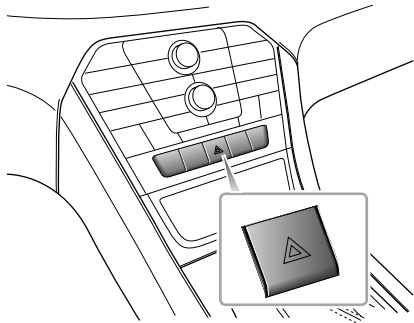

Before you stop or slow the car in an emergency, always press the hazard warning switch. All the direction indicators will flash together to warn other road users when your car is causing an obstruction or is in a hazardous situation. Remember to switch off before driving away.

Warning Triangle

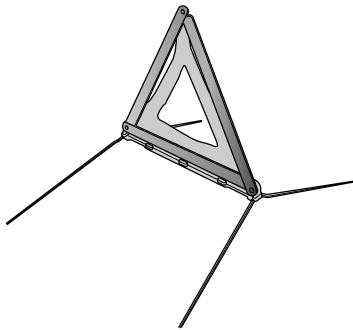

The warning triangle supplied with your car is stowed in the loadspace.

If you have to stop your car on the road in an emergency, you must place a warning triangle approximately 50 - 150 metres behind the car, if possible, to warn other road users of your position.

Emergency Starting

Using Booster Cables



NEVER start the engine by pushing or towing.



Make sure that **BOTH** batteries are of the same voltage (12 volts), and that the booster cables are approved for use with 12 volt car batteries.



Ensure sparks and naked lights are kept well away from the engine compartment.

Using booster cables (jump leads) from a donor battery, or a battery fitted to a donor vehicle, is the only approved method of starting a car with a flat battery.

If the battery from a donor vehicle is to be used, the vehicles should be parked with their battery locations adjacent to one another. Ensure that the two vehicles do not touch.

Starting the Vehicle



Ensure that each booster cable connection is securely made. There must be no risk of the clips accidentally slipping from the battery terminals (as a result of engine vibration, for example), this could cause sparking, which could lead to fire or explosion.

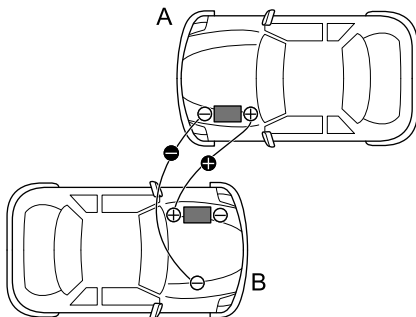

EMERGENCY INFORMATION

Remove the ignition key and switch off ALL electrical equipment of BOTH vehicles, then follow the instructions below:

- 1 Connect the RED booster cable between the positive (+) terminals of both batteries. Connect the BLACK booster cable from the negative (-) terminal of the donor battery (A) to a good earth point (an engine mounting or other unpainted surface, for example), at least 0.5 m from the battery and well away from fuel and brake lines on the disabled vehicle (B) .
- 2 Check that the cables are clear of moving parts of both engines, then start the engine of the donor vehicle and allow it to idle for a few minutes.
- 3 Now start the engine of the vehicle with the discharged battery (DO NOT crank the engine for more than 10 seconds). If the disabled vehicle will not start after several attempts, it may need to be repaired. Please contact the MG Authorised Repairer for an overhaul.

- 4 After both the vehicles have normally started, allow the engines to idle for more than 2 minutes before shutting down the engine of the donor vehicle and disconnecting the jumper cables.
- 5 Disconnecting the booster cables must be an exact reversal of the procedure used to connect them, i.e.disconnect the BLACK cable from the earth point on the disabled vehicle FIRST.

IMPORTANT
NEVER turn on any electrical equipment on the started vehicle before removing the booster cables.

Vehicle Recovery

Towing for Recovery

Towing Eye



DO NOT use a tow rope that is twisted - any untwisting force could unscrew the front towing eye.

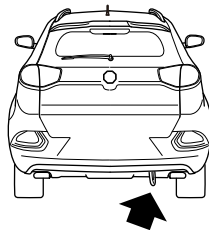
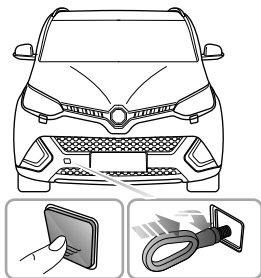

EMERGENCY INFORMATION

Your car is equipped with a removable towing eye, that can be used at the front or the rear of your vehicle. The towing eye is stored in the tool kit beneath the loadspace floor when not in use.

To fit the towing eye, remove the small cover set into the bumper by pressing firmly on the bottom left corner, then screw the towing eye into its mounting behind the bumper (see illustration). Ensure the towing eye is fully tightened.

Note: *The towing eye cover may be secured to the bumper by a plastic cord.*

Both towing points are intended for use by qualified recovery specialists to assist in the recovery of your car when a breakdown or accident occur. They are not designed for towing other vehicles, and must NEVER be used to tow a trailer or caravan.

Towing for Recovery



If, due to an electrical fault, potential safety hazards may exist, it is not suggested that the ignition be switched to position II.



When towing, DO NOT suddenly accelerate or brake suddenly, this can cause accidents.

Suspended Towing

If your car needs to be towed, most qualified recovery specialists will use wheel lift equipment to suspend the front wheels, while the rear wheels remain on the ground.

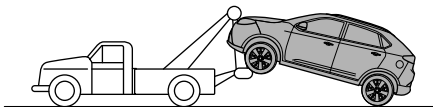

Four-Wheel Touchdown Towing



The towing speed of a vehicle with manual transmission must not exceed 20 mph (30 km/h), the towing distance must not exceed 30 miles 50 km.



The towing speed of a vehicle with dual clutch automatic transmission must not exceed 20 mph (30 km/h), the towing distance shall not exceed 30 miles (50 km).

If vehicle is towed with the four wheels on the ground, observe the following precautions:

- 1 Switch the ignition to position II to enable the brake lights, wipers and direction indicators to be operated if necessary. If, due to an electrical fault, it is considered unsafe to switch the ignition on, the car will need to be recovered on a trailer.
- 2 Place the gear shift lever in neutral.
- 3 Release the hand brake.

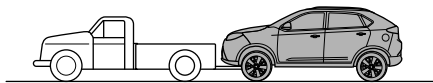

Without the engine running, greater effort will be required to operate the brake pedal and turn the steering wheel. Longer stopping distances will also be experienced.

EMERGENCY INFORMATION

Transporter or Trailer with Rope

If your car is to be transported on the back of a trailer or transporter, it must be secured as illustrated:

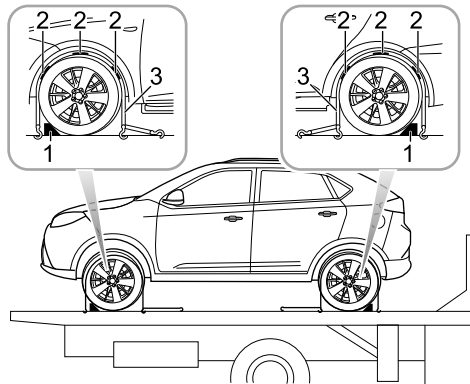

Position the car on the trailer, apply the hand brake and place the gear shift lever in neutral. Fit wheel chocks (1) as shown, then position the anti slip rubber blocks (2) around the circumference of the tyre.

Fit the lashing straps (3) around the wheels and secure to the trailer. Tighten the straps until the car is securely held.

EMERGENCY INFORMATION

Tyre Repair and Wheel Replacement

Tool Identification *

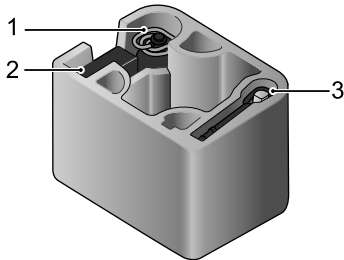

- 1 Repair Fluid Reservoir
- 2 Electric Air Pump
- 3 Towing Hook

Tyre Repair *

- 1 Remove the label at the bottom of the repair fluid reservoir and attach it to the steering wheel to remind the driver not to exceed 50 MPH (80 km/h).

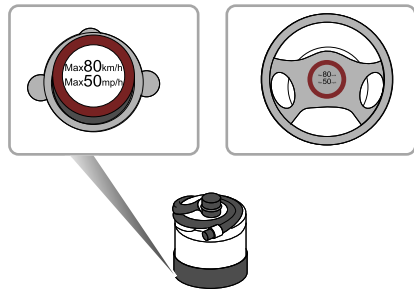

- 2 Connect the air hose of the electric air pump to the repair fluid reservoir, fit the tyre sealant bottle (upright) into the slot on the compressor. Remove the valve dust cap of the flat tyre, and connect the filler hose from the tyre sealant bottle to the tyre

EMERGENCY INFORMATION

valve. Ensure that the power switch of the electric air compressor is switched off (i.e., press “O”), then insert the plug from the compressor into the centre console power socket.



Note: To avoid battery discharge, it is recommended to keep the engine running.

- 3 Switch on the power switch of the electric compressor (i.e., press “-”), to start pumping sealant into the tyre. The tyre sealant bottle will become empty after

approximately 30 seconds. The tyre should reach the specified inflation pressure of 2.3 bar (36 psi) within 5 or 10 minutes.

Note: The pressure gauge may briefly reach 6 bar (87 psi), then the pressure begins to drop to normal.

- 4 When the required pressure is reached, switch off the power switch of the electric compressor (i.e., press “O”).

Note: If the required pressure cannot be reached within 10 minutes, please disconnect the compressor, drive the vehicle 10 metres (33 feet) approx forward or backward to allow the sealant to spread within the tyre. If the required pressure can still not be reached, the tyre is severely damaged and you should seek assistance from the MG Authorised Repairer.

Note: Consecutive operation of Electric air compressor for more than 10 minutes may result in damage to the compressor.

EMERGENCY INFORMATION

Note: *Under no circumstances should you continue your journey with a deflated tyre. Driving a vehicle with a deflated tyre is extremely dangerous.*

- 5 Remove the tyre sealant bottle from the slot in the compressor, disconnect the hose from the tyre valve, remove the compressor plug from the centre console power socket, return the tyre repair kit to its stowage tray.
- 6 After successfully adding sealant to the tyre, drive immediately for a short time (around one minute) this will allow the sealant to distribute evenly inside the tyre. Continue driving and do not exceed 50 MPH (80 km/h). After a further 10 minutes, find a safe place to stop and recheck the tyre pressure.
 - If the tyre pressure has dropped to less than 0.8 bar (11.6 psi), do not continue driving, seek assistance instead.
 - If the pressure is greater than 0.8 bar (11.6 psi) after a 10 minutes drive, correct the tyre pressure (see tyre pressure label) and continue. Check again after another 10 minute drive. If 1.8 bar (26.1 psi) cannot

be reached, do not continue drive, seek assistance instead. Do not exceed 50 MPH (80 km/h).



- If the pressure has not dropped after the second 10 minutes drive, continue. If 1.8 bar (26.1 psi) cannot be reached, do not continue drive, seek assistance instead. Do not exceed 50 MPH (80 km/h) or 125 miles (200 km).

EMERGENCY INFORMATION

Note: *DO NOT* remove foreign objects (eg. screws,nails) from the tyre. The tyre repair system must only be used when the foreign object is in the tread pattern (A), *DO NOT* attempt a repair when the damage is in the sidewall of the tyre (B).

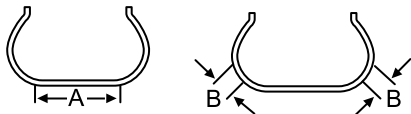

Spare Wheel and Tool Kit *

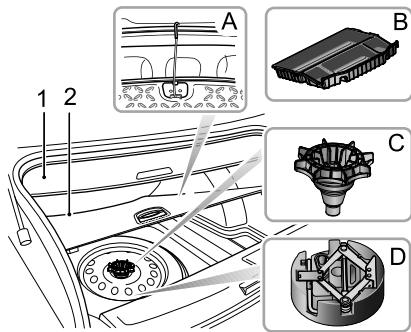

- 1 Pull up the luggage cover (1) if any.
- 2 Lift the luggage carpet handle (2), and fix it in place to the roof with the attached hook.
- 3 Unscrew the spare wheel retaining nut (C) and lift the wheel from the storage space.
- 4 Remove the tool kit (D).

EMERGENCY INFORMATION

Spare Wheel Replacement Tool

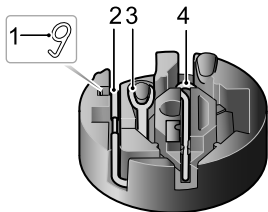

- 1 Wheel bolt cap removal tool
- 2 Wheel bolt spanner
- 3 Towing hook
- 4 Jack handle
- 5 Jack

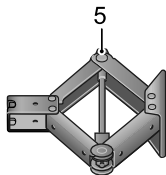

Changing a Wheel *

If you need to change the wheel during the journey, choose a safe place to stop away from the main road if possible. Always ask your passengers to get out of the car and wait in a safe area away from other traffic.

Switch on hazard warning lamps. If available, position a warning triangle about 50 to 150 metres behind your vehicle to warn approaching traffic.

Before changing a wheel, ensure the front wheels are in the straight ahead position. Apply the parking brake and place the gear shift lever of transmission in N position.

Observe the following precautions:

- Ensure the jack is positioned on firm, level ground.
- If the vehicle must be parked on the hill, place chocks in front of and behind other 3 wheels to prevent the vehicle moving.

EMERGENCY INFORMATION

Positioning the Jack



NEVER work beneath the car with the jack as the only means of support. The jack is designed for wheel changing only!



NEVER jack the car using any jacking points other than the jacking points. Serious damage to the car could result.



Avoid accidental contact with any underbody parts, especially hot exhaust system components.

Position the jack on firm level ground under the jacking point nearest the wheel to be removed. Note that the domed head of the jack must fit into the corresponding recess in the sill plate (see inset in illustration).

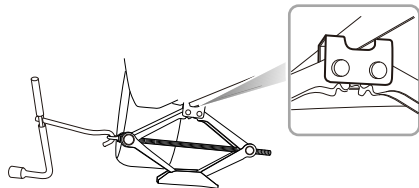
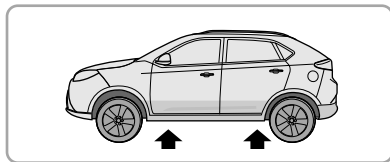

Turning the jack screw by hand, adjust the jack until the jack head fits snugly onto the sill in the correct area. Ensure that the base of the jack is in full contact with the level ground.

EMERGENCY INFORMATION

Fitting the Spare Wheel



Regularly check the spare wheel tyre pressure, it may not be used for long periods of time. After fitment, at the first opportunity check and adjust the tyre pressure.



The wheel bolts must be tightened to the specified torque after changing a wheel (120 ~ 130 Nm).

- 1 Before raising the car, use the vehicle tool to remove each wheel bolt cap. Use the wheel bolt spanner to slacken each bolt half a turn anti-clockwise.
- 2 Turn the handle in a clockwise direction until the tyre is clear of the ground.
- 3 Remove the wheel bolts and place them in the tool tray to prevent them from being lost. Make sure the vehicle is steady and there is no risk of slip or movement before removing wheel bolts.
- 4 Remove the road wheel.

Note: Avoid placing wheels face down on the ground - the surface may be scratched.

- 5 Fit the spare wheel and tighten the wheel bolts with wheel bolt spanner until the wheel is seated firmly against the hub.
- 6 Lower the car and remove the jack, then FULLY tighten the wheel bolts in a diagonal sequence.
- 7 Finally, return the tools to the toolbox, put the toolbox into the well of the boot floor; tighten the spare wheel retaining nuts, and put the replaced wheel above the toolbox in the well in the load space floor (face down). Lower the boot floor, and put the boot storage box on the boot floor.

Note: DO NOT stand on the handle of the wheel bolt spanner or use extension tube on the handle of the spanner.

Note: When replacing the wheel, please fully tighten the bolts in the diagonal sequence twice.

Note: *Note: Consult your MG Authorised Repairer or tyre specialist for a replacement tyre, as soon as possible.*

Spacesaver Spare Wheel



Only one spacesaver spare wheel can be used at any one time, otherwise the operational performance and brake performance may be reduced, thereby leading to accident or injury to yourself and others.



When driving on icy or slippery surfaces it is advised to fit the spacesaver wheel to the rear of the vehicle to maintain adequate stability. This may mean swapping a front wheel with a rear wheel.



Snow chains can not be used on the spacesaver spare wheel, this can cause damage to the car and snow chain.

When the spacesaver spare wheel is fitted, the vehicle speed should not exceed 50 MPH (80 km/h). Please have the full-scale tyre repaired and replace the spare wheel as

soon as possible. This will extend the life span of the spare wheel for other emergencies.

Note: *DO NOT use an automatic car wash when the spacesaver wheel is fitted, the guide rails of the car wash may conflict with the wheel/tyre and cause damage.*

EMERGENCY INFORMATION

Fuse Replacement

Fuse

Fuses are simple circuit breakers which protect the car's electrical equipment by preventing the electrical circuits from being overloaded. A blown fuse may be indicated when the item of electrical equipment it protect stops working.

The mounting location and rating of each fuse in engine compartment fuse box and battery fuse box is shown on the label printed on the fuse box cover.

If a fuse is suspected faulty, you may remove it from the fuse box and observe if the metal wire in the fuse is blown.

It is recommended to have spare fuses in the vehicle, which can be obtained from a local MG authorised repairer.

Comparison before and after the fuse is blown

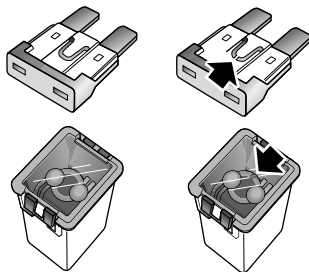

IMPORTANT

- NEVER attempt to repair a blown fuse. ALWAYS replace a fuse with one of the same rating.
- If a replaced fuse fails immediately, please contact an MG Authorised Repairer as soon as possible.

EMERGENCY INFORMATION

Fuse Box

The vehicle is equipped with 3 fuse boxes:

- Battery fuse box (on the battery)
- Passenger compartment fuse box (behind the right dashboard panel cover)
- Engine compartment fuse box (front left of the engine compartment)

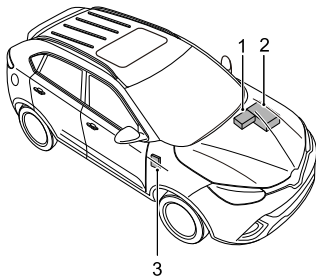

- 1 Battery Fuse Box
- 2 Engine Compartment Fuse Box
- 3 Passenger Compartment Fuse Box

Battery Fuse Box

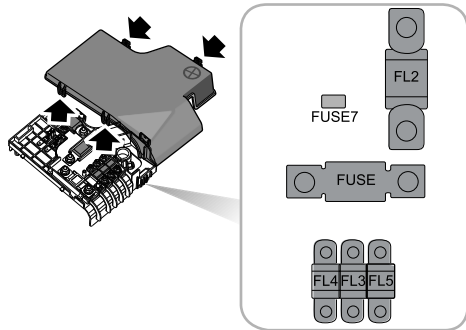

Check or Replace a Fuse

- 1 Turn off the ignition switch and all electrical appliances, and disconnect the battery negative cable.
- 2 Press the lock catch (arrowed), remove the upper cover of battery fuse box.
- 3 Check if any fuse is blown.

EMERGENCY INFORMATION

- If a fuse is blown, replace it with another fuse of the same ampere value.

Fuse Specification

Code	Specs	Function
FUSE	-	-
FUSE7	5A	Power management DC convertor
FL2	200A	Alternator
FL3	60A	Electronic power assisted steering
FL4	200A	Engine compartment fuse box
FL5	50A	Passenger compartment fuse box

Passenger Compartment Fuse Box

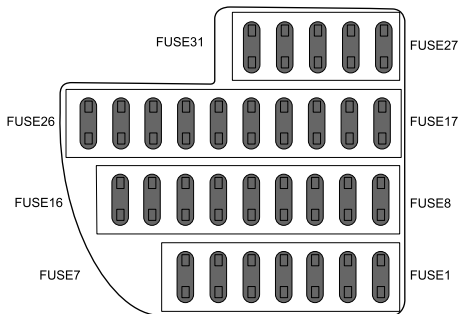

Check or Replace a Fuse

- Turn off the ignition switch and all electrical appliances, and disconnect the battery cable.
- Remove the driver side dashboard panel cover to access the fuse box.

EMERGENCY INFORMATION

- 3 Hold the fuse head with the fuse extraction tool, pull and remove the fuse, and check if the fuse is blown.
- 4 If a fuse is blown, replace it with another fuse of the same ampere value.

Fuse Specification

Code	Specs	Function
FUSE1	15A	Rear accessories power socket
FUSE2	-	-
FUSE3	-	-
FUSE4	-	-
FUSE5	-	-
FUSE6	5A	Radio
FUSE7	15A	Front 12V power socket
FUSE8	25A	TCM (7AT)
FUSE9	-	-

Code	Specs	Function
FUSE10	5A	Driver door switch pack
FUSE11	10A	Gateway
FUSE12	5A	Parking distance control unit , rain sensor
FUSE13	20A	Headlamp , dynamic headlamp leveling control module
FUSE14	2A	Ignition switch
FUSE15	5A	Immobiliser coil
FUSE16	10A	Diagnostic socket
FUSE17	5A	Slip control system
FUSE18	5A	Power management DC convertor
FUSE19	20A	Seat heater switch
FUSE20	-	-
FUSE21	7.5A	PRND display , EPB Switch , exterior mirror adjustment , switch-stop/start system

EMERGENCY INFORMATION

Code	Specs	Function
FUSE22	10A	Supplemental restraint system
FUSE23	-	-
FUSE24	-	-
FUSE25	5A	Master light switch
FUSE26	-	-
FUSE27	-	-
FUSE28	5A	Instrument pack
FUSE29	10A	ATC controller/MTC controller
FUSE30	5A	A/C and ICE interface
FUSE31	15A	Radio/color radio/NAV

EMERGENCY INFORMATION

Engine Compartment Fuse Box

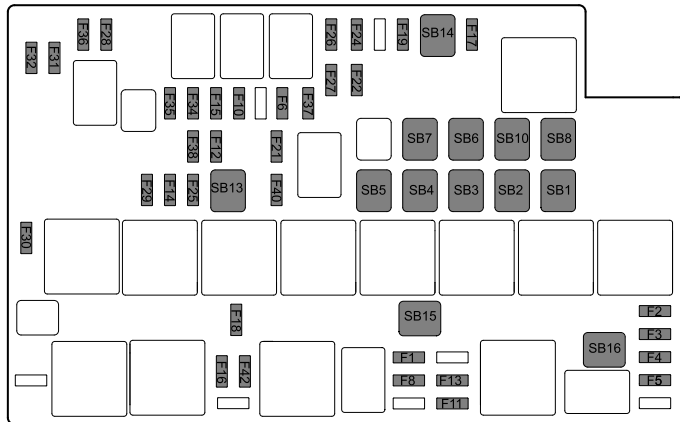

5

EMERGENCY INFORMATION

Check or Replace a Fuse

- 1 Turn off the ignition switch and all electrical appliances, and disconnect the battery negative cable.
- 2 Press the lock catch to open the upper cover of engine compartment fuse box.
- 3 Hold the fuse head with the fuse extraction tool, pull and remove the fuse, and check if the fuse is blown.
- 4 If a fuse is blown, replace it with another fuse of the same ampere value.

Fuse Specification

Code	Specs	Function
F1	10A	Engine control module
F2	15A	Engine control module

Code	Specs	Function
F3	20A	Upstream oxygen sensor, downstream oxygen sensor, clutch bottom sensor, variable camshaft timing exhaust, variable camshaft timing intake, electronic thermostat
F4	15A	Heat air flow meter, ignition coil 1, 2, 3, 4
F5	10A	Canister purge valve, wastegate control valve, dump valve, brake lamp switch sensor, oil control valve, neutral switch
F6	7.5A	Exterior mirror heater
F7	—	—
F8	20A	Fuel pump relay
F9	—	—
F10	30A	Driver door window lift motor

EMERGENCY INFORMATION

Code	Specs	Function
F11	5A	Supplemental restraint system
F12	25A	Body control module
F13	20A	Passenger power seat adjustment switch
F14	25A	Body control module
F15	30A	Front passenger door window lift switch
F16	10A	TCM(TST) , engine control module , shift control module (TST)
F17	10A	Air condition compressor relay
F18	5A	Engine control module
F19	20A	Driver power seat adjustment switch
F20	—	—

Code	Specs	Function
F21	10A	Ignition switch relay
F22	25A	Body control module
F23	-	-
F24	5A	Transmission relay coil (TST)
F25	25A	Body control module
F26	30A	Rear left window lift switch
F27	30A	Rear right window lift switch
F28	20A	Horn relay
F29	25A	Front wiper relay
F30	20A	Front windscreen washer relay
F31	20A	Rear windscreen wiper relay
F32	20A	Rear windscreen washer relay
F33	-	-

EMERGENCY INFORMATION

Code	Specs	Function
F34	10A	Front left headlamp
F35	10A	Front right headlamp
F36	30A	Headlamp washer relay
F37	15A	Front fog lamp relay
F38	25A	Body control module
F39	-	-
F40	30A	Rear windscreen heater relay
F41	-	-
F42	10A	Reverse lamp switch (6MT), body control module , instrument pack , MTC controller
SB1	30A	Main relay
SB2	60A	Cooling fan-high speed
SB3	50A	Cooling fan-middle speed

Code	Specs	Function
SB4	40A	KL.R power control relay
SB5	40A	Starter relay
SB6	30A	Slip control system-valve
SB7	40A	Slip control system-pump
SB8	40A	Blower relay
SB9	-	-
SB10	25A	Body control module
SB11	-	-
SB12	-	-
SB13	40A	TCM (TST)
SB14	40A	Electrical park brake control module
SB15	40A	Power management DC convertor
SB16	40A	Cooling fan-low speed

Bulb Replacement

Bulb Specification

Bulb	Type
Low Beams (halogen)	H7 55W
Low Beams (xenon)	D3S 35W
High Beams	H7 55W
Front Sidelamps	W5W 5W
Front Fog Lamps	H8 35W
Front Turning Signal Lamps	WY21W 21W
Indicator Side Repeater Lamps	WY5W 5W
Reverse Lamps	W16W 16W
Rear Fog Lamps	W21W 21W
Rear Sidelamps (low configuration)	W5W 5W
Brake Lamp/Rear Sidelamps (low configuration)	W21/5W 21/5W

Bulb	Type
License Plate Lamps	W5W 5W
Rear Turning Signal Lamps	WY21W 21W
High Mounted Stop Lamp	W5W 5W
Front Interior Lamp	W5W 5W
Rear Interior Lamp	C10W 10W
Glove Box Lamp	C10W 10W
Boot Lamp	C10W 10W
Daytime Running Lamp	LED (non-serviceable)
Rear Sidelamps (high configuration)	LED (non-serviceable)
Brake Lamp/Rear Sidelamps (high configuration)	LED (non-serviceable)

EMERGENCY INFORMATION

Replacing Bulbs

Before replacing any bulb, turn off the lighting switch to avoid any possibility of a short circuit.

Note: *Only replace bulbs with the same type and specification.*

Take care NOT to touch the glass with your fingers; always use a cloth to handle the bulb. If necessary, clean the glass with methylated spirits to remove fingerprints.

If in doubt, when replacing bulbs, contact a specialist workshop. For other bulbs not listed and to be replaced, ask an MG Authorised Repairer for help.

The bulb removal procedure is as follows (The installation procedure is in reverse order, so it will not be described here), for other bulbs not listed and to be replaced, ask an MG Authorised Repairer for help.

Front Interior Lamp and Reading Lamp

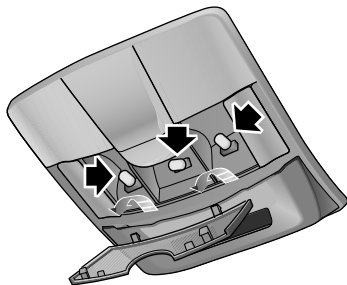

- 1 Use a small flat-bladed screwdriver to gently prise the lens from the light unit.
- 2 Pull the bulbs from their mountings to remove.

Replacement of the bulb is a reversal of the removal process. When replacing the lens, locate the two prongs at the front of the lens and then carefully flex the lens to locate the two prongs at the rear of the lens into the light unit. Push the lens upwards until it 'clicks' into position.

Rear Interior Lamp

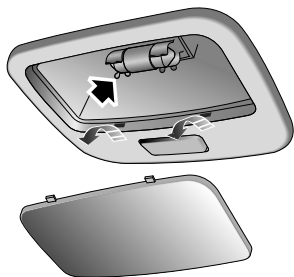

- 1 Use a small flat-bladed screwdriver to gently prise the lens from the light unit.
- 2 Pull the bulb from its mounting to remove.

Replacement of the bulb is a reversal of the removal process. When replacing the lens, locate the two prongs at the front of the lens and then carefully flex the lens to locate the two prongs at the rear of the lens into the light unit. Push the lens upwards until it 'clicks' into position.

Glove Box Lamp * and Loadspace Lamp

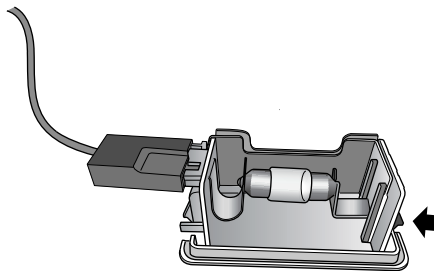

- 1 Insert a small flat-bladed screwdriver into the indent on one of the narrow sides of the lens (see arrow in illustration) and carefully press the unit from its location.
- 2 Pull the bulb to remove.

The fitting steps of the bulb are opposite to the removal steps.

Maintenance

284 *Maintenance*

288 *Bonnet*

290 *Engine Compartment*

291 *Engine*

294 *Cooling System*

296 *Brake*

298 *Battery*

300 *Washer*

302 *Wipers*

304 *Tyre*

309 *Cleaning and Vehicle Care*

MAINTENANCE

Maintenance

Routine Servicing

The safety, reliability and performance of your car will depend partly on how well it is maintained. You must ensure that maintenance is carried out when required and according to the information contained in the 'Warranty & Maintenance Handbook'.

Servicing

The message centre shows the next service information. Refer to 'message centre' in 'Instruments and Controls' chapter. After the completion of each service, the next service display will be reset by your MG Authorised Repairer.

Note: If a service is not carried out (or the display is not reset), the next service display will be wrong.

Service History

Ensure your MG Authorised Repairer register the Service History after each maintenance.

Brake Fluid Replacement

The brake fluid requires replacement according to the information contained in the 'Warranty & Maintenance Handbook'.

Note: Brake fluid replacement will be an additional cost.

Coolant Replacement

The engine coolant (anti-freeze and water solution) needs to be replaced according to the information contained in the 'Warranty & Maintenance Handbook'.

Note: Coolant replacement will be an additional cost.

Emission Control

Your car is fitted with emission and evaporative control equipment designed to meet specific territorial and legal requirements. Incorrect engine settings may adversely affect exhaust emissions, engine performance and fuel consumption, as well as causing high temperatures, which could result in damage to the catalytic converters and engine.

IMPORTANT

You should be aware that unauthorised replacement, modification or tampering with this equipment by an owner or motor vehicle repairer could result in the manufacturer's warranty being deemed as invalid. In addition, engine settings must not be tampered with.

Owner Maintenance



Any significant or sudden drop in fluid levels, or uneven tyre wear, should be reported without delay. For further information, refer to the MG Authorised Repairer.

In addition to the routine services referred to previously, a number of simple checks must be carried out more frequently. You can carry out these checks yourself and advice is given on the pages that follow.

Daily checks

- Operation of lights, horn, direction indicators, wipers, washers and warning lights.
- Operation of seat belts and brakes.

- Look for fluid deposits underneath the car that might indicate a leak.
- Check tyre appearance.

Weekly Check

- Engine oil level.
- Coolant level.
- Brake fluid level.
- Screen washer fluid level.
- Tyre pressures and condition.
- Operate air conditioning.

Note: The engine oil level should be checked more frequently if the car is driven for prolonged periods at high speeds.

Special Operating Conditions

If your car is frequently used in dusty conditions, or operated in extreme climates where sub-zero or very high ambient temperatures are normal, more frequent attention may need to be paid to servicing requirements. You need to carry out special maintenance operations (refer to Warranty & Maintenance handbook or contact your MG Authorised Repairer).

MAINTENANCE

Safety in the Garage



Cooling fans may commence operating after the engine is switched off, and continue operating for a number of minutes. Keep clear of all fans while working in the engine compartment.

If you need to carry out maintenance, observe the following safety precautions at all times:

- Keep your hands and clothing away from drive belts and pulleys.
- If the car has been driven recently, **DO NOT TOUCH** exhaust and cooling system components until the engine has cooled.
- **DO NOT TOUCH** electrical leads or components while the engine is running, or with the ignition switch on.
- **NEVER** leave the engine running in an unventilated area - exhaust gases are poisonous and extremely dangerous.
- **DO NOT** work underneath the car with a wheel changing jack as the only means of support.

- Ensure that sparks and naked lights are far away from the engine compartment.
- Wear protective clothing, including, where practicable, gloves made from an impervious material.
- Remove watches and jewelry before working in the engine compartment.
- **DO NOT** allow tools or metal parts of the car to make contact with the battery leads or terminals.

Toxic Liquid

Fluids used in motor vehicles are poisonous and should not be consumed or brought into contact with open wounds. These include: battery acid, coolant, brake fluid, power steering fluid, fuel, engine oil and windscreen washer additives.

For your own safety, **ALWAYS** read and obey all instructions printed on labels and containers.

Used Engine Oil

Prolonged contact with engine oil may cause serious skin disorders, including dermatitis and cancer of the skin. Wash thoroughly after contact. Used engine oil should

be disposed of correctly. Incorrect disposal can cause a threat to the environment.

MAINTENANCE

Bonnet

Opening the Bonnet



DO NOT drive when the bonnet is open or retained only by the safety catch.

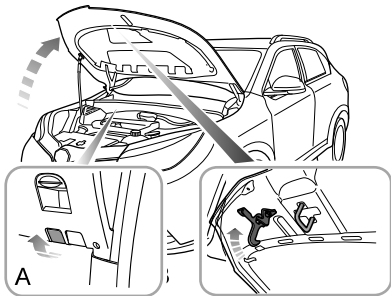

- 1 Pull the bonnet release handle (A) from the inside of the car.
- 2 Push the lever (B) mounted on the bonnet to release the bonnet safety catch.
- 3 Raise the bonnet and hold it up with the support rod firmly.

Closing the Bonnet

Support the bonnet by one hand, release the support rod using the other hand, and place it firmly into the support rod base. Then hold the bonnet using both hands and lower it, allowing it to drop for the last 20cm ~ 30 cm to fully close the bonnet.

By attempting to lift the front edge of the bonnet, check if the lock is fully engaged after closing the bonnet. If it is not fully engaged, you must repeat the operation.

Bonnet Open Alarm

If the bonnet is not fully engaged, when the ignition switch is in II/III position, the corresponding alarm icon (refer to "Information Centre" in "Instruments and Controls"

chapter) will be displayed in the information centre. If it is detected that the bonnet is not fully engaged while driving, an audible warning will sound.

IMPORTANT

- For safety reasons, the bonnet should be closed well when driving. Therefore you must check after closing the bonnet that the bonnet is securely latched, e.g. the bonnet edge is flush with the body of the car.
- You should stop the car immediately when safety permits and close the bonnet if it is not closed fully when driving.
- Beware of injury to hands while fully closing the bonnet with a downward force.

MAINTENANCE

Engine Compartment



While working in the engine compartment, always observe the safety precautions listed under "Safety in the Garage", refer to "Maintenance" in "Service and Maintenance" section.

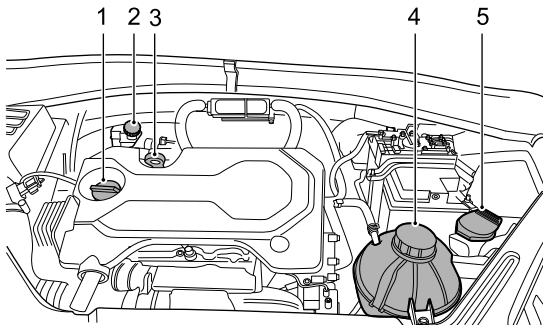

- 1 Oil filler cap (black cap)
- 2 Brake fluid reservoir (yellow cap)
- 3 Oil dipstick (yellow)
- 4 Coolant reservoir (black cap)
- 5 Washer fluid reservoir (blue cap)

Engine

Engine Oil

ACEA Classification of Engine Oils

European Automobile Manufacturers Association (ACEA) will classify the engine oils based on performance and quality. To ensure the best performance of the vehicle, please use ACEA C3 engine oil or that recommended by the manufacturer.

Choose a different viscosity of oil according to the ambient temperature in which your vehicle is operating. If temperature range is minimal, continue using the oil with original viscosity.

If you are using your vehicle in areas of extreme cold, we advise you to use oil of a SAE 0W-30 viscosity.

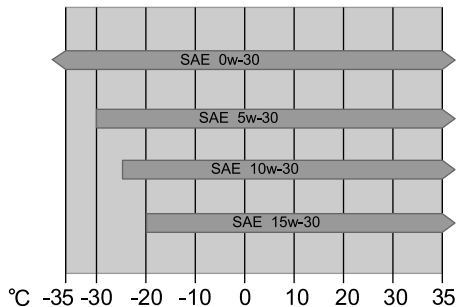

MAINTENANCE

Engine Oil Level Check and Top Up



Driving the car with the oil level ABOVE the upper mark, or BELOW the lower mark on the dipstick, will damage the engine. Take care to avoid spilling engine oil onto a hot engine – a fire may result!

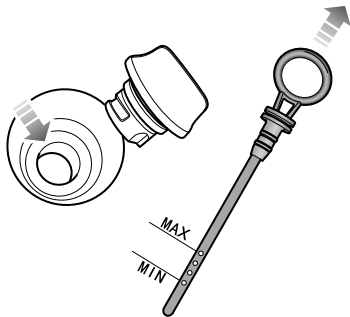

Check the oil level weekly and top up with oil when necessary. Ideally, the oil level should be checked with the engine cold and the car resting on level ground. However, if the engine is running and already getting warm, wait for at least five minutes after switching off the ignition switch before checking the level.

- 1 Withdraw the dipstick and wipe the blade clean.
- 2 Slowly insert the oil dipstick and pull it out again to check the oil level; the oil level shall not be lower than the "MIN" mark on the oil dipstick.
- 3 Clean off any debris that may have collected around the oil filler cap area. Unscrew the oil filler cap and refill the oil to maintain the oil level between the "MAX" mark and "MIN" mark on the oil dipstick.
- 4 Wait for 5 minutes and then recheck the oil level, adding more oil if necessary – DO NOT OVERFILL!
- 5 Finally, ensure the dipstick and filler cap are replaced.

Engine Oil Specification

Use the engine oil recommended and approved by the manufacturer. Refer to "Recommended Fluids and Capacities" in "Technical Data" section.

Note: *Do not use any oil additive.*

IMPORTANT
Check the engine oil more frequently if the car is driven at high speeds for prolonged periods.

MAINTENANCE

Cooling System

Coolant Check and Top Up



DO NOT remove the coolant reservoir cap when the cooling system is hot - escaping steam or hot coolant could cause serious injury.

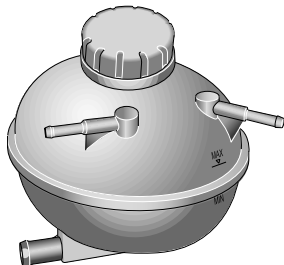

The coolant level should be checked weekly when the cooling system is cold and with the car resting on level ground.

If the coolant level is below MIN level, remove the pressure cap when cold and add correct coolant mix to MAX level.

Note: Prevent coolant coming into contact with the vehicle body in adding. Coolant will damage paint.

If the coolant level falls appreciably during a short period, suspect leakage or overheating and arrange for a MG Authorised Repairer to examine the car.

Coolant Specification

Please use the coolant (mix of water and antifreeze) which is recommended and certified by the manufacturer. Please refer to 'Recommended Fluids and Capacities'.

Note: *In an emergency, top up the cooling system with clean water, but be aware of the resultant reduction in frost protection. DO NOT top up or refill with other coolant formulations.*

Note: *Refilling of rust inhibitor inapplicable to this car or other coolant additives into coolant may damage the engine. For more details on rust inhibitor or additives, please consult an MG Authorised Repairer.*

Antifreeze



Antifreeze is poisonous and can be fatal if swallowed - keep containers sealed and out of the reach of children. If accidental contact is suspected, seek medical attention immediately.



Prevent antifreeze coming into contact with the skin or eyes. If this occurs, rinse immediately with plenty of water. If eyes are still red, painful or uncomfortable, seek medical attention immediately.

MAINTENANCE

Brake

Brake Pads



DO NOT rest your foot on the brake pedal while driving; this may overheat the brakes, reduce their efficiency and cause excessive wear.

For the first 900 miles (1500 km), you should avoid situations where heavy braking is required.

Remember that regular servicing is vital to ensure that all the brake components are examined for wear at the correct intervals, and replaced when required to ensure long term safety and optimum performance during the interval prescribed in Warranty and Maintenance Manual.

The car needs to run in for 500 miles (800 km) after the brake pad or disc is replaced.

Brake Fluid Check and Top Up



Brake fluid is highly toxic, keep containers sealed and out of the reach of children. If accidental contact of brake fluid is suspected, seek medical attention immediately.



Prevent brake fluid coming into contact with the skin or eyes. If this occurs, rinse immediately with plenty of water. If eyes are still red, painful or uncomfortable, seek medical attention immediately.

The brake fluid level should be checked weekly when the system is cold and with the car on level ground.

The fluid level can be seen through the reservoir neck and should be maintained as close to the "MAX" mark as possible. Do not allow the level to drop below the "MIN" mark.

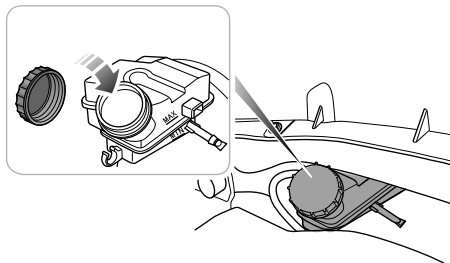

IMPORTANT

Replace brake fluid regularly according to the warranty and maintenance manual.

Note: Brake fluid will damage painted surfaces. Soak up any spillage with an absorbent cloth immediately and wash the area with a mixture of car shampoo and water.

Brake Fluid Specification

Use the brake fluid recommended and approved by the manufacturer. Refer to "Recommended Fluids and Capacities" in the "Technical Data" section.

MAINTENANCE

Battery

Battery Maintenance



DO NOT leave electric components switched on when the engine is not running, the battery may become flat and you will not be able to start the engine.

To access the battery, release the fixings and move the top of the battery cover aside then you will see the battery shown as the illustration. The battery is designed to be maintenance free, so topping-up is unnecessary.

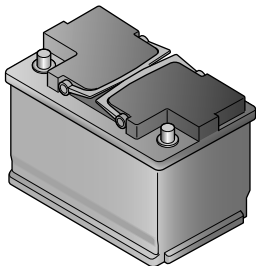

Note: If the vehicle is stored for more than 1 month, remove the earth lead from the battery. Make sure that the ignition switch has been turned off before connecting or disconnecting the earth lead. When connecting the earth lead again, the vehicle must be left in a locked state for 4 hours to re-calibrate the battery condition. Failure to adhere to this will inhibit the stop/start functionality.

Battery Replacement



The battery contains sulphuric acid, which is corrosive.

Please go to a MG Authorised Repairer to remove and install the battery. Only fit a replacement battery of the same type and specification as the original to maintain the correct vehicle functionality.



The battery must be disposed of using an approved method, used batteries can be harmful to the environment. It should be recycled by a professional company. Please consult an MG Authorised Repairer more details.

MAINTENANCE

Washer

Washer Fluid Check and Top Up



Washer fluid is flammable. DO NOT allow washer fluid to come into contact with naked flames or sources of ignition.



When filling the washer fluid, DO NOT let the washer fluid spill on parts around the engine or on the paint surface of vehicle body. In case the washer fluid is spilled on hands or other parts of the body, please immediately wash with clean water.

Check the washer fluid level every week. When the level of washer fluid is low, please top up the washer fluid as instructed.

If your car is equipped with a washer fluid level sensor, when the level is low, the information centre will display text and icon. Refer to "Information Centre" in "Instruments and Controls" section for details.



Note: DO NOT use an anti-freeze or vinegar/water solution in the washer reservoir - anti-freeze will damage paintwork while vinegar will damage the washer pump.

IMPORTANT

- Use the washer fluid recommended and certified by the manufacturer. Misuse of washer fluid in winter may cause damage to the washer motor due to freezing.
- Using the washer switch when there is no washer fluid may cause damage to the washer motor.
- Operating the wipers when the windscreen is dry and there is no washer fluid may cause damage to the windscreen and wipers. Please spray the washer fluid and start the wipers when there is adequate washer fluid.

Washer Nozzles

Operate the washers periodically to check that the nozzles are clear and properly directed.

If the nozzle is obstructed, insert a needle or thin metal wire into the hole to remove the obstruction.

Washer Fluid Specification

Use the washer fluid recommended and certified by the manufacturer. Refer to "Recommended Fluids and Capacities" in the "Technical Data" section.

MAINTENANCE

Wipers

Wiper Blades

IMPORTANT

- Grease, silicon and petroleum products impair the blade's wiping capability. Clean the wiper blades in warm soap water, and check their status periodically.
- Clean the windscreen frequently. **DO NOT** use wipers to remove stubborn or ingrained dirt, it will reduce their effect and their life span.
- If signs of hardness or cracking in the rubber are found, or if the wipers leave streaks or unwiped areas on the screen, then the wiper blades should be replaced.
- Clean the windscreen regularly with an approved glass cleaner and ensure the windscreen is thoroughly cleaned before fitting replacement wiper blades.
- Only fit replacement wiper blades that are identical to the original specification.
- Clean ice and snow from around the wipers and ensure they are not frozen or otherwise sticking to the windscreen before attempting to operate them.

Replacing Wiper Blades

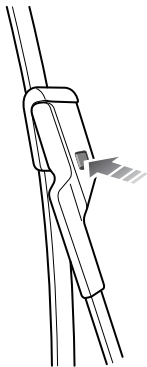

- 1 Lift the wiper arm away from the windscreen.
- 2 Press the button on the wiper arm, and pull the upper end of the wiper blade outward to disengage from the wiper arm.
- 3 Unhook the blade from the wiper arm and discard.
- 4 Locate the new wiper into the slot of the wiper arm.
- 5 Push the wiper blade towards the arm until the wiper blade button is engaged.
- 6 Check whether the wiper blade is fitted correctly to the arm before positioning on the windscreen.

MAINTENANCE

Tyre

Outline

- Take extra care when using new tyres for the first 300miles (500km).
- Avoid excessive cornering at speed.
- Regularly check tyres for damage and foreign objects - remove any foreign objects from the tread.
- Avoid tyre contact with oils, grease and fuel.
- Ensure valve caps are always fitted.
- If the tyre is to be removed always mark the tyre/wheel orientation to ensure correct refitment.

New Tyres

New tyres may not have the same adhesion properties of the old tyres, please take extra care for 300miles (500km). This action could benefit tyre life. Tyre or rim damage can happen unnoticed. If abnormal vibrations or handling is experienced, or you think tyre or rim damage has occurred please contact an MG Autorised Repairer.

Directional Tyres

Directional tyres are marked with 'direction of rotation' (DOR). To maintain handling characteristics, tyre performance, low road noise and extend tyre life, tyres/wheels must always be fitted with indication arrow showing the correct 'DOR'.

Tyre Life

Correct tyre pressures and moderate driving style can extend tyre life. Recommendations:

- If the vehicle is to be stored for a lengthy time, please move at least one time in two weeks to 'rotate the tyres'.
- Tyre pressures should be checked regularly when the tyres are cold.
- Avoid cornering at excessive speeds.
- Regularly check tyres for abnormal wear patterns. The following factors affect the tyre life.

Tyre Pressures

Incorrect tyre pressures can result in poor driving characteristics and a shortened tyre life. Tyre pressures

should be checked at least once a month, and once prior to each long-distance journey.

Driving Style

Excessively harsh acceleration and braking whilst cornering will reduce tyre life.

Wheel Balance

Shaking or vibration of the vehicle or steering mechanism can indicate out of balance wheels. It is important to rectify this quickly as to prevent wear on steering and suspension components and shorten tyre life.

Wheel Alignment

Incorrect wheel alignment can cause excessive tyre wear and affect vehicle safety. If the tyres show signs of abnormal wear seek advice from an MG Authorised repairer.

Caring for Your Tyres



DEFECTIVE TYRES ARE DANGEROUS!
DO NOT drive if any tyre is damaged, is excessively worn, or is inflated to an incorrect pressure.

Always drive with consideration for the condition of the tyres, and regularly inspect the tread and side walls for any sign of distortion (bulges), cuts or wear.

Note: If possible, protect tyres from contamination by oil, grease and fuel.

Tyre Pressures



Before a long distance journey, the tyre pressure must be checked.

Check the pressures (including the spare wheel) at least every week, when the tyres are cold.

If it is necessary to check the tyres when they are warm, you should expect the pressures to have increased by 0.03 ~ 0.04MPa/0.3 ~ 0.4bar/4.3 ~ 5.8psi. In this

MAINTENANCE

circumstance, NEVER let air out of the tyres in order to match the recommended pressures (cold).

Valves

Keep the valve caps screwed down firmly - they prevent dirt from entering the valve. Check the valve for leaks (listen for a tell-tale hissing) when you check the tyre pressure.

Punctured Tyres

Your vehicle is fitted with tyres which may not leak if penetrated by a sharp object, provided the object remains in the tyre. If you are aware of this occurring, reduce speed immediately and drive with caution until the spare wheel can be fitted, or repairs undertaken.

Note: *If the sidewall of the tyre is damaged or distorted, replace the tyre immediately, do not attempt a repair.*

Tyre Wear Indicators

Tyres fitted as original equipment have wear indicators moulded into the tread pattern at several points around the circumference.

When the tread has worn down to 1.6mm, the indicators will come to the surface of the tread pattern, producing the effect of a continuous band of rubber across the width of the tyre.

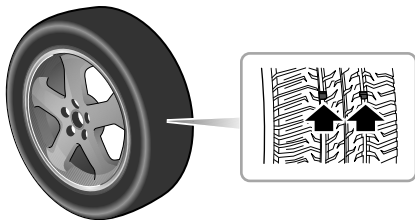

IMPORTANT

The tyre must be replaced when it is worn to reveal the wear indicator, or there might be the risk of accident.

Replacement of Tyres



It is recommended to fit tyres having the same specification to the original tyres. Alternative tyres, of a different specification, or unqualified tyres may adversely affect the car's driving characteristics and safety. For better guarantee of your safety, we recommend you consult the MG Authorised Repairer.

Dynamic balancing is available for wheels after replacement.

Wheel Fitment Rotation

In order to balance tyre wear, it may benefit from rotating tyre position. Wheels can be swapped front to rear in order to even spread tyre wear across all tyres.

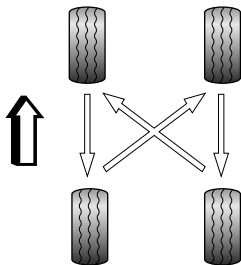

Note: *Directional tyres CANNOT be swapped from side to side.*

MAINTENANCE

Tyre/Snow Chains

Unsuitable tyre/snow chains may damage the tyres, wheels, suspension, brakes or bodywork of your car.

Please pay attention to the following requirements in the usage:

- The tyre/snow chains can only be fitted on the front wheels;
- The thickness of tyre/snow chains shall not exceed 12 mm;
- Please always observe the installation and tension instructions for the tyre/snow chains, as well as the speed limitations of different roads;
- Do not drive faster than 30mph (50km/h);
- To avoid the tyre damage and excessive wear of the tyre/snow chains, the tyre/snow chains must be removed while driving on the road without snow.

Note: If you drive on the snowy and icy roads, it is recommended to use winter tyres. Consult an MG Authorised Repairer for details.

Note: Snow chains can only be fitted to the 17" tyre.

Cleaning and Vehicle Care



Observe all safety precautions on cleaning products; do not drink fluids and keep them away from the eyes.

Washing Your Car



Some high pressure cleaning systems will penetrate door, window and sunroof seals, and damage lock mechanisms. DO NOT aim water jets directly at components that might be easily damaged.

In order to preserve the paint finish on your car, please observe the following care points:

- DO NOT use hot water to wash the car.
- DO NOT use detergents or washing up liquid.
- In hot weather, DO NOT wash the car in direct sunlight.
- When using a hose, DO NOT aim the water directly at window, door or sunroof seals, or through wheel apertures onto the brake components.

If the car is particularly dirty, use a hose to flush grime and grit from the bodywork, prior to washing. Then, wash the car using cold or lukewarm water containing a good quality wash and wax shampoo. Always use plenty of water to ensure that grit is flushed from the surface and not ground into the paintwork. After washing, rinse the bodywork with clean water and dry off with a chamois leather.

Cleaning the underside



DO NOT use a high pressure hose to clean the engine compartment – damage to the car's electronic systems may occur.

From time to time, but particularly during winter months when salt has been used on the roads, use a hose to wash the underside of the car. Flush away accumulations of mud and thoroughly clean those areas where debris can easily collect (wheel arches and panel seams, for example).

Removing tar spots

Use white spirit to remove tar spots and stubborn grease stains from the paintwork. Then wash the area immediately with soapy water to remove all traces of the spirit.

MAINTENANCE

Body protection

After washing, examine the paintwork for damage. If the damage has revealed bare metal, use a coloured primer first, then apply the correct colour base coat and finish off with a lacquer pencil, if appropriate. Carry out this treatment after washing but before polishing or waxing.

More extensive damage to paint or bodywork must be repaired in accordance with the manufacturer's recommendations. Failure to do this will invalidate the Anti-Corrosion Warranty. If in doubt, ask your MG Authorised Repairer.

Polishing the paintwork



DO NOT use car polish containing coarse abrasives – these will remove the paint film and damage the gloss finish.

Occasionally treat the paint surface with an approved polish containing the following properties:

- Very mild abrasives to remove surface contamination without removing or damaging the paint.

- Filling compounds that will fill scratches and reduce their visibility.
- Wax to provide a protective coating between the paint and the elements.

Note: If possible, avoid applying polish or wax products to window glass and rubber seals.

Wiper blades

Wash in warm soapy water. DO NOT use spirit or petrol based cleaners.

Windows and mirrors

Regularly clean all windows, inside and out, using an approved glass cleaner.

Windscreen: In particular, clean the outside of the screen with glass cleaner after washing the car with wash and wax products, and before fitting new wiper blades.

Rear screen: Clean the inside with a soft cloth, using a side to side motion to avoid damaging the heating elements.

Note: *DO NOT* scrape or use abrasive cleaners on the inside of the rear screen – this will damage the heating elements.

Mirrors: Wash with soapy water. Use a plastic scraper to remove ice. *DO NOT* use abrasive cleaning compounds or metal scraper.

Cleaning the Interior

Plastic materials

Clean plastic-faced materials with diluted upholstery cleaner, then wipe with a damp cloth.

Note: *DO NOT* polish dashboard components – these should remain non-reflective.

Carpet and fabrics

Clean with diluted upholstery cleaner - test a concealed area first.

Leather

Clean leather trim with warm water and a non-detergent soap. Dry and polish the leather with a dry, clean, lint-free cloth.

Note: *DO NOT* use petrol, detergents, furniture creams or polishes as cleaning agents.

MAINTENANCE

Instrument pack, clock, audio system and navigation display

Clean with a dry cloth only. DO NOT use cleaning fluids or sprays.

Airbag module covers



DO NOT allow these areas to be flooded with liquid and DO NOT use petrol, detergent, furniture cream or polishes.

To protect damage to the airbag SRS, the following areas should be cleaned sparingly with a damp cloth and upholstery cleaner ONLY:

- Steering wheel centre pad.
- Area of dashboard containing the passenger airbag.
- Area of roof lining and front pillar finishers which enclose the side head impact protection modules.

Seat Belts



DO NOT use bleaches, dyes or cleaning solvents on seat belts.

Extend the belts, then use warm water and a non-detergent soap to clean. Allow the belts to dry naturally; DO NOT retract them or use the car until they are completely dry.

Technical Data

314 Technical Data Dimensions

315 Weights

316 Major Parameters of Engine

*317 Recommended Fluids and
Capacities*

*318 Wheel Alignment (Unladen
Condition)*

318 Wheels and Tyres

318 Tyre Pressures(Cold)

TECHNICAL DATA

Technical Data Dimensions

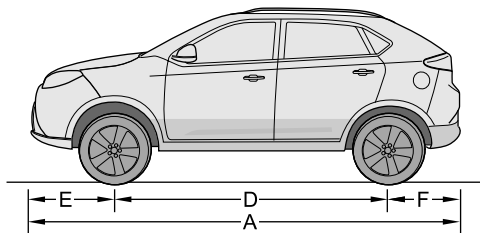
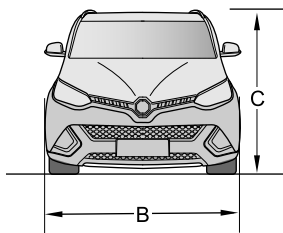

Item, units	Parameter
Overall length A, mm	4500
Overall width B, mm	1855
Overall height C (unladen, excluding luggage rack), mm	1675
Wheelbase D, mm	2650
Front Overhang E, mm	954
Rear Overhang F, mm	896

Item, units	Parameter
Front wheel track, mm	1574
Rear wheel track, mm	1593
Minimum turning circle diameter, m	11.8
Fuel tank capacity, l	55
Luggage capacity, l	335 ~ 1336

Weights

Item, units	Parameter	
	1.5T MT	1.5T TST
Person in cab, person	5	
Unladen vehicle weight (kerb), kg	1420	1460
Gross vehicle weight, kg	1859	1899

Towing Weights

Item, units	Parameter	
	1.5T MT	1.5T TST
Towing limit un-braked, kg	730	750
Towing limit braked, kg	1750	1750
Towing hitch load, kg	75	75

TECHNICAL DATA

Major Parameters of Engine

Vehicle	Parameter	
	1.5T MT	1.5T TST
Bore × Stroke, mm × mm	74×86.6	
Capacity, l	1.490	
Compression ratio	10:1	
Maximum net power, kw	119	
Rated power, KW	124	
Engine speed to develop rated power, rev/min	5600	
Maximum torque, Nm	250	
Engine speed to develop maximum torque, rev/min	1700-4400	
Idle speed, rev/min	750	
Fuel type, RON	Unleaded 95 RON to EN228 SPEC	

Recommended Fluids and Capacities

Name	Grade	Capacity	
		1.5T MT	1.5T TST
Engine oil(initial assembly), l	C3 5W-30	5.5	
Engine oil(after-sales replacement), l		5.0	
Engine coolant, l	Glycol (OAT)	7.1	
Automatic transmission fluid, l	DEXRON®DCT Fluid	-	2.45
Manual transmission oil, l	MTF94	2.2	-
Brake fluid, l	DOT 4	0.8	
Washer fluid, l	QX35	5	
Air conditioning refrigerant, g	R1234yf	560±20	
Air conditioning compressor oil, ml	PS-R1	130±10	

TECHNICAL DATA

Wheel Alignment (Unladen Condition)

Item		Parameter
Front	Camber angle	$-14 \pm 45 \phi$
	Castor angle	$4^{\circ} 57 \pm 45 \phi$
	Toe-in	$8 \pm 12 \phi$
	King pin inclination	$12^{\circ} 45 \pm 45 \phi$
Rear	Camber	$-60 \pm 45 \phi$
	Rear Toe-in	$12 \pm 12 \phi$

Tyre Pressures(Cold)

Wheel	All conditions
Front Wheel	230 kPa/2.3 bar/34 psi
Rear Wheel	230 kPa/2.3 bar/34 psi

Wheels and Tyres

Wheel size	6.5J×17	7.5J×18
Tyre size	215/60 R17 96H	235/50 R18 97W

A

ABS (Anti-lock braking system) 26, 226-227, 232
ABS warning light 26
Accessory power socket 55
Air conditioning 64-75
Air distribution 67-75
Air recirculation 69, 75
Air vents 64-66
Airbag SRS 23, 44, 164, 171, 312
Airbag SRS service information 171-172
Airbag SRS warning light 23
Airbags driver and front passenger 164-170
Airbags - side head curtain 169
Airbags - side pelvis/thorax 168
Alarm system 190-195
Ambient temperature 72, 76, 208, 219, 236, 291
Anti-freeze 284, 295, 300
Anti-theft alarm indicator 190-193
ASL(Active speed limit) 10, 15-16, 240, 243-245
ATC (Automatic temperature control)* 70-75
Auto Hold 224-225
Audio system equipment 76-145
Automatic courtesy lights 53, 54
Automatic dimming interior mirror 47
AUTO lights 32
AUTO air conditioning 70-71

Auto store - audio controls 80-81
AUX devices - audio 78, 82-84
Average fuel consumption 17-20
Average speed 17-20

B

Backrest adjustment - seats 150-151 153
BAND button - audio controls 77-78, 80-81
Battery - key 187-188
Battery maintenance 298
Battery replacement 299
Blower (ATC)* 70-74, 194, 236-237, 250
Blower (MTC)* 67-69, 194, 236-237, 250
Bluetooth phone 98-102
Bonnet opening 288
Booster cables 255
BDW (Brake Disc Wiping) 202, 221
Britax Child Seats 181
Brake fluid 27, 284-286, 290, 296-297, 317
Brake fluid specification 297, 317
Brake lights 259
Brake pad wear indicator 296
Brakes 201, 215, 222, 224, 229-233, 285, 296, 308
Braking in an Emergency 226
Bulb replacement 279-281
Bulb specification 279

INDEX

C

- Camera - rear parking 248
- Capacities 317
- Car washes 46, 61, 224, 269
- Centre vents 64-65
- Check engine warning light 27
- Child proof locks 189
- Child restraints and seats 173-184
- Cleaning - car interior 311-312
- Cleaning - paintwork 309-311
- Clock 10, 137, 312
- Cold climates 198
- Coolant check, top-up and replacement 294
- Coolant level warning light 27, 28
- Coolant specification 295, 317
- Cooling system 286, 294-295
- Courtesy lights 53-54
- Cruise control* 7, 24, 217, 240-245
- Cubby box 59
- Cup holders 60
- Current journey 17-20

D

- Daily checks 285
- Data - Technical 313-318

- Daytime Running Lamps 33
- Default - trip computer 16-20
- Defrosting/demisting 74-75, 236-237
- Digital speed 17, 20
- Dimensions 314
- Dipped beam headlights 14, 23, 32-33, 37, 135
- Dipstick 290, 292
- Direction indicator bulb - front 14, 37
- Direction indicator bulb - rear 14, 37
- Direction indicator lights 14, 23, 36-37, 191, 254
- Disabling passenger air-bag 170
- Door mirror - folding 45-46
- Door mirrors 45-46

E

- Ejecting USB device safely 83
- Electric seats* 151
- EBA (Electronic Brake Assist) 222
- EBD (Electronic brake force distribution) 222
- Electronic Parking Brake 13, 29-30, 223, 227-230
- Emission control 284-285
- Engine compartment 169, 236, 255, 270-272, 275-276, 286-287, 290, 309
- Engine compartment fuses 271-272
- Engine fault light 27
- Engine immobilisation 187, 190, 198-199

Engine number 3
Engine coolant temperature gauge 8
Engine oil 285-287, 291-293, 317
Environmental driving 201
EPS(Electric power assisted steering) 28, 43

F

Face level vents 64-66
Fast forward - audio controls 89, 94, 123, 125
Fog lamps switch 35
Follow me home 33
Foot brake 221
Front fog lamps* 14, 36, 278-279
Front courtesy and reading lights 53
Front cup-holder 60
Front wiper operation 38-39
Front wiper blade replacement 303
Fuel consumption 17-18, 20, 201-204, 207, 216-217, 284
Fuel filler 9, 208
Fuel filling 207-208
Fuel gauge 9-10, 17
Fuel specification 207
Fuel system 14, 207
Functions - Vehicle Options menu 11, 16-21
Fuses, replacement and colour 270-278
Fuse box (passenger compartment) 271-274

Fuse boxes (engine compartment) 275-278
Fuse box battery top 271

G

Gauges 8-10
Gearbox number 3
Gear change display 11, 214, 241
Gear change warning indicator 11
Gear lever 209-213, 241
Global window open and close 191
Glovebox 57
Glovebox light bulb 279, 281

H

Hazard warning lights 2, 23, 37, 55, 254, 266
Hazard warning triangle 254
Head restraints 148, 153
Headlamp bulb 37, 279
Headlamp flash 37
Headlamp levelling 34-35
Headlamp washers 40
Headlamps 32-37, 40
Heated mirrors 45
Heated rear screen 67, 69, 74
Heated seats 151-152

INDEX

Heavy loads 202
Hill Hold Function 13, 215, 222-223
Horn 7, 44, 191-192, 277

I

Identification numbers 3
Ignition 7, 9-11, 16, 18, 20, 23-34, 36-38, 41, 44-46, 50-51, 53, 55-56, 78, 85, 165, 188, 190, 194, 196-199, 213, 222-223, 229, 231, 235-236, 240-244, 246, 256, 258-259, 271-273, 276-277, 286, 288, 292, 298, 300
Immobilisation 187, 190, 198-199
Indicators 5, 22-23, 36-37, 74, 161, 254, 259, 285, 306
Instrument dimmer 34
Instrument pack 5, 7-10, 20, 23, 30, 32-34, 37, 161, 165, 187, 190, 208, 217, 219, 222, 225, 228-229, 233, 235, 237-238, 240, 244, 274, 278, 312
Intelligent Stop/Start 12, 29, 235-239, 252
Intelligent TPMS (Tyre Pressure Monitoring System)* 19-20, 25, 233-234
Interior door handles 194
Interior lights 53
Interior locking switch 193
ISOFIX restraints 177, 179-181

J

Jump leads 229, 255
Jump starting 255

K

Keys 186-188

L

Lamp failure and monitoring 14
Last journey 17-20
Lighting switch 7, 32-34, 37, 280
Lights off delay 33
Load carrying 250
Loadspace light bulb 281
Locking 42, 95, 134, 153, 191, 226
Low oil pressure 25
Lumbar support adjustment 151

M

Main beam headlights 7, 19, 23, 36-37
Maintenance 18-19, 27, 161-162, 171, 203-204, 206, 233, 283-287
Manual transmission 11, 209, 317

Manual front seats 150
 Map reading lights 53
 Menu 19-21
 Message centre 10-12, 19-20, 22-30, 37, 52, 219, 284
 Mirrors - door 45
 Mirrors - interior 47-48
 Mirrors cleaning 310
 Mirrors - folding 45-46
 Mislock 191-193
 MTC (Manual temperature control) 67-69
 MUTE button - audio controls, 77-78, 90, 116

N

Next service 18-19, 284
 Number plate lamps (license plate) 279

O

Odometer 10-11
 Oil level check - engine 25, 285, 292
 Oil top-up 292
 "One-touch" windows 51-52
 Opening the bonnet 288

P

Parking aid* 246-248
 Parking camera* 248
 Parking brake 20, 29-30, 85, 197, 199, 211, 213, 215, 222, 224-225, 227, 266
 Particle/pollen filter 65
 Passenger air-bag disabling 170
 Passenger compartment fuses 271-274
 Poisonous fluids/gases 197, 205, 286, 295
 Polishing the paintwork 310
 Power socket 55-56
 Power-mirror folding* 45-46
 Power-operated seats* 151
 Power-operated windows 50-52
 Pre-tensioners 160-161
 Programmed Wash/Wipe 40-41
 Punctured tyres 233-234, 305-308

R

Rain sensor* 38, 202, 273
 Rear courtesy lights 54
 Rear fog lamps 14, 33, 36-37, 134-135, 279
 Rear parking camera parking aid* 246-249
 Rear screen heater 69, 74-75
 Rear seats - folding 153

INDEX

Rear view mirror - automatic dimming 47
Rear view mirror - manual 48
Rear window isolation switch 50-52
Recirculation 69, 75
Recommended fluids 317
Recovery 257-260
Remote key 33, 186-188, 191-192, 195
Remote key battery 187
Reverse light bulbs 278-279
Roof luggage rack* 61
Routine servicing 285
Running-in 201

S

Safety in the garage 286
Search tuning - audio controls 80
Seat belt pre-tensioners 160
Seat belts 154-163, 312
Seat belt warning 12
Seat cushion height 150-151
Seat heaters 151-152
Seats - manual 150
Seats - power operated 151
Security 186, 191
Service information 171, 284
Service interval display 18, 65

Setting date and time 143-144
Side airbags 164, 169
Side head impact protection 164, 166-169
Sidelight bulb 279
Side lamps 32-34, 36-37, 279
Single point entry 191
Slip Control System (SCS) 221, 223, 229, 231-233, 241-242
Snow chains 232-233, 269, 308
Sound settings - audio controls 79
Speed warning 243-244
Speed locking 194
Speedometer 9, 22
SRC - Source button - audio controls 77-78, 80, 82, 89, 94
Starting 196-199
Steering column adjustment 42
Sunvisor 49

T

TA - Traffic Announcement button - audio controls 141-142
Tailgate opening 194-195
Technical data 314-318
Temperature control - ATC* 70-71
Temperature control - MTC* 67
Temperature gauge 10

Thirty-minute play function - audio controls 78
Top tether restraint 177-178
Towing eyes 257-258
Towing weights 315
Towing for recovery precautions 251-252
Track search - audio controls 82
Traction control (TC) 26, 231-232
Transporter or trailer lashing 260
Transmission 3, 11, 13-15, 209-220
Trip computer 11, 16-20
Trip recorder 10, 17-20
Tyre pressures 17, 25, 202, 204, 233-234, 263, 268, 285, 304-306, 318
TPMS - (Tyre Pressure Monitoring System)* 19-20, 25, 233-234
Tyre wear indicators 306
Tyres 20, 201-202, 204, 226, 233-234, 304-308, 318

U

Units 20
Unlocking 134, 186, 189, 191, 193
Upper anchorage seat belt height adjustment 159
USB socket 76, 82-83
Used engine oil 286-287

V

Vanity mirrors 49
Variable delay - wipers 40
Vehicle identification number 3-4
Vehicle information display 11
Vehicle recovery 257-260
Ventilation 64-66
VIN plate 3

W

Warning lights 22-31
Warning messages and symbols 12-16
Warning triangle 254
Washer jets, fluid and top-up 285, 290-297, 300-301, 317
Washing the car 309
Weekly checks 285
Weights 315
Welcome lights (Find my car) 33
Wheels 306-307
Wheel alignment 318
Windows 50-52, 191, 310
Window lift switch 7, 50-52
Windows - cleaning 310
Windscreen washer check and top-up 285, 290, 300-301, 317

INDEX

Windscreen wipers 38-41, 202, 221, 285, 302-303

Wiper blade - cleaning 302

Wiper blade replacement 303

Wiper controls 38-41



MG MOTOR UK

Lowhill Lane, Longbridge,

Birmingham B31 2BQ

www.mg.co.uk

Version 1.01